

### Specifications

Parameter	Unit	Minimum	Typical	Maximum
Center Frequency	MHz	-	700	-
Insertion Loss	dB	-	2	3
1 dB Bandwidth	MHz	-	37.36	-
3 dB Bandwidth	MHz	46.6	48.45	-
35 dB Bandwidth	MHz	-	119.39	55
Passband Variation( $f_0 \pm 20\text{MHz}$ )	dB	-	0.1	1
Absolute Delay	usec	-	0.02	-
Group Delay Variation( $f_0 \pm 20\text{MHz}$ )	nsec	-	20	-
Ultimate Rejection	590~670MHz	dB	7	8
	730~810MHz	dB	7	17
	1~590MHz	dB	35	50
	810~1000MHz	dB	35	53
Material Temperature coefficient	KHz/°C	-47.6		
Ambient Temperature	°C	25		
Package Size	SMD3.8*3.8			

#### Notes:

1. All specifications are based on the test circuit shown
2. In production, devices will be tested at room temperature to a guardbanded specification to ensure electrical compliance over temperature
3. Electrical margin has been built into the design to account for the variations due to temperature drift and manufacturing tolerances
4. This is the optimum impedance in order to achieve the performance show

### Matching Configuration

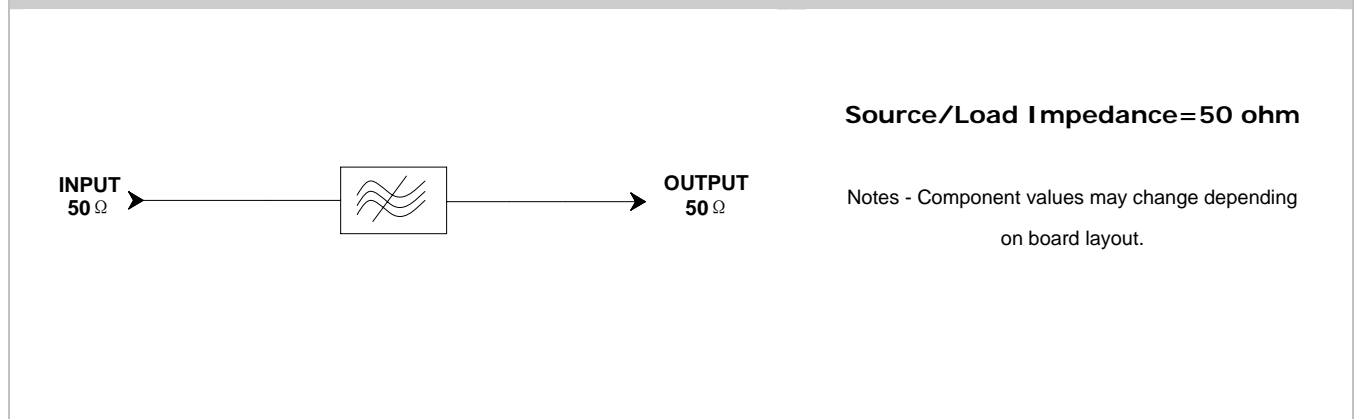

	<b>SIPAT Co., Ltd.</b> ( CETC No. 26 Research Institute ) Nanping Huayuan Road No. 14 Chongqing, China, 400060	Part Number	SP70001	
		Rev. Date	2007-04-26	
		Ver.	1.0	Page

*Package Dimension*

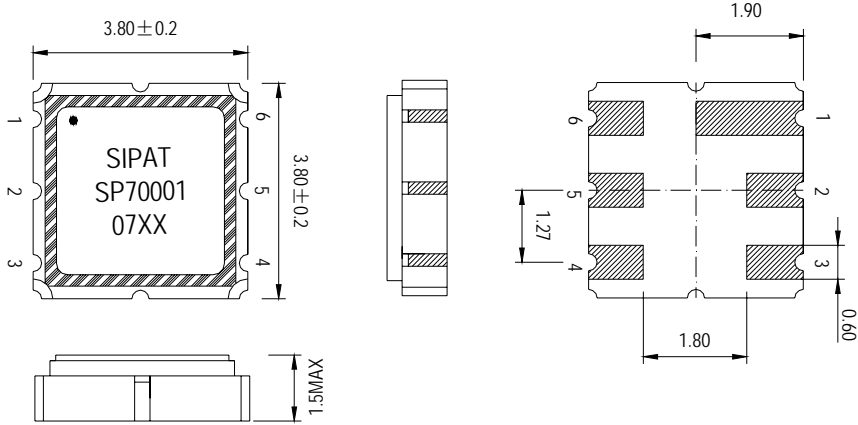

- 1) -: Pad Number 1 Index
- 2) SIPAT: Manufacturer name
- 3) SP70001: Part Number
- 4) 07XX: Date Code

Input	2
Output	5
Ground	1,3,4,6

**Package: SMD3.8\*3.8**

**Unit: mm**



**SIPAT Co., Ltd.**  
( CETC No. 26 Research Institute )  
Nanping Huayuan Road No. 14  
Chongqing, China, 400060

Part Number	SP70001	
Rev. Date	2007-04-26	
Ver.	1.0	Page 2/4

Typical Performance

Frequency Respond

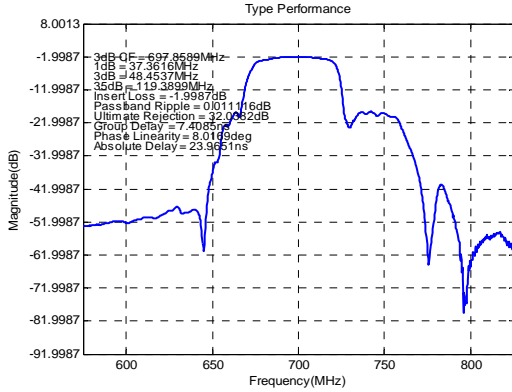

Horizontal: 50MHz/Div Vertical: 10dB/Div

Passband Respond

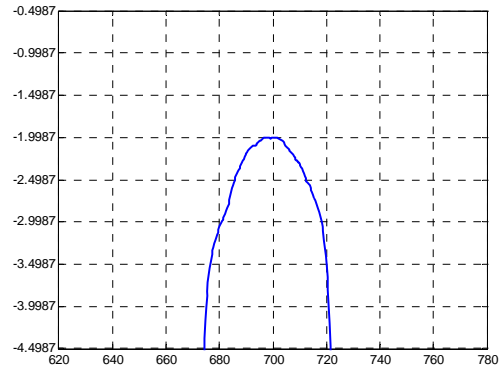

Horizontal: 20MHz/Div Vertical: 0.5dB/Div

Group Delay Variation(f0±20MHz)

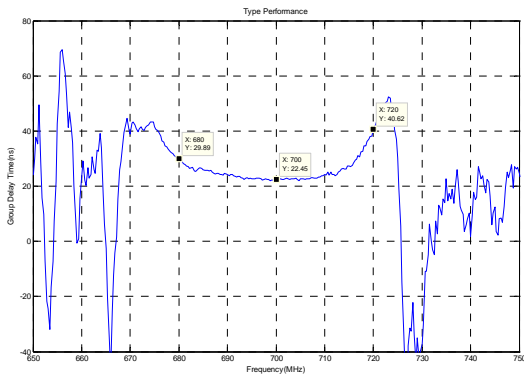

Horizontal: 10MHz/Div Vertical: 20ns/Div

Phase Linearity(f0±20MHz)

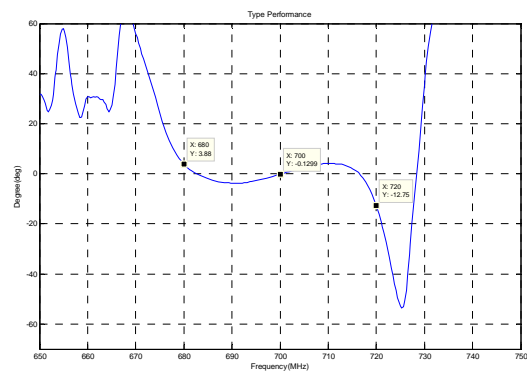

Horizontal: 10MHz/Div Vertical: 20deg/Div

Smith Chart S11

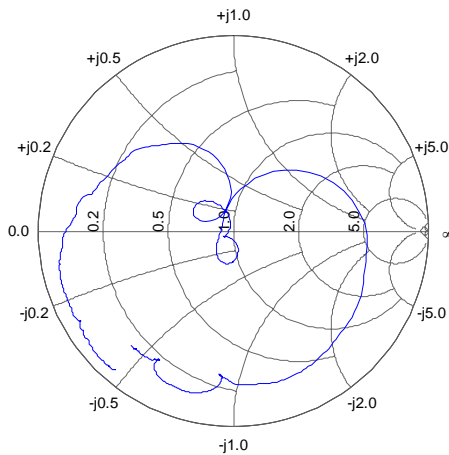

Smith Chart S22

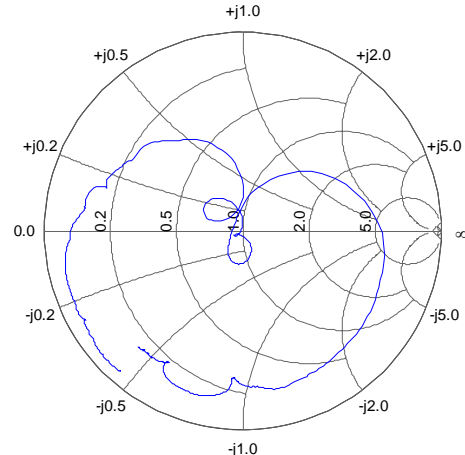

**SIPAT Co., Ltd.**  
( CETC No. 26 Research Institute )  
Nanping Huayuan Road No. 14  
Chongqing, China, 400060

Part Number SP70001

Rev. Date 2007-04-26

Ver. 1.0

Page 3/4

*Maximum Ratings*

<b>Operating Temperature Range</b>	°C	[-40°C;+85°C]
<b>Storage Temperature Range</b>	°C	[-40°C;+105°C]
<b>DC Voltage</b>	V	0
<b>Input Power</b>	dBm	10 max
<b>ESD Class</b>		1

	<b>SIPAT Co., Ltd.</b> ( CETC No. 26 Research Institute ) Nanping Huayuan Road No. 14 Chongqing, China, 400060	Part Number	SP70001	
		Rev. Date	2007-04-26	
		Ver.	1.0	Page