

500mA 3-Terminal Positive Voltage Regulator

Features

- Output Current up to 0.5A
- Fixed Output Voltages of 5V and 12V
- Output Voltage Tolerances of $\pm 5\%$ over the Full Temperature Range
- Internal Short Circuit Current-Limiting
- Internal Thermal Overload Protection
- Available in Lead Free, RoHS Compliant Packaging

TO-220 Package

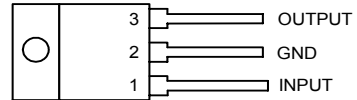

Applications

- Consumer Electronics
- Microprocessor Power Supply
- Mother Board I/O Power Supply

General Description

The SP78MXX series are monolithic integrated circuits designed as fixed-voltage regulators for a wide variety of applications including local, on-card regulation.

This series of regulators are complete with internal current limiting, thermal shutdown protection, and safe-area compensation which make them virtually immune from output overload. If adequate heat sinking are provided, these regulators can deliver output currents up to 0.5A.

The SP78MXX series are available in two standard plastic packages: TO-220 and TO-252.

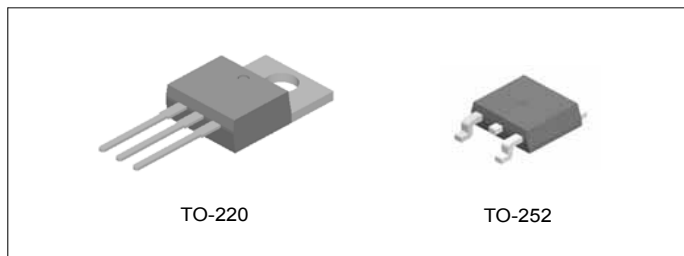

Figure 1. Package Types of SP78MXX

Pin Configuration

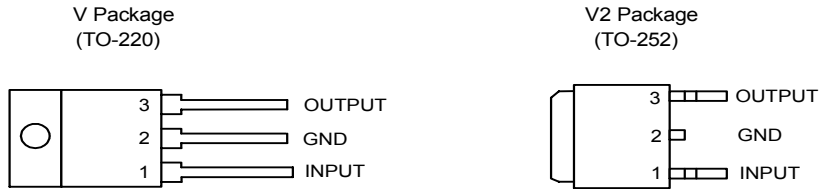

Figure 2. Pin Configuration of SP78MXX (Top View)

Pin Description

Pin Number	Pin Name	Function
1	INPUT	Voltage Input
2	GND	Ground
3	OUTPUT	Voltage Output

Functional Block Diagram

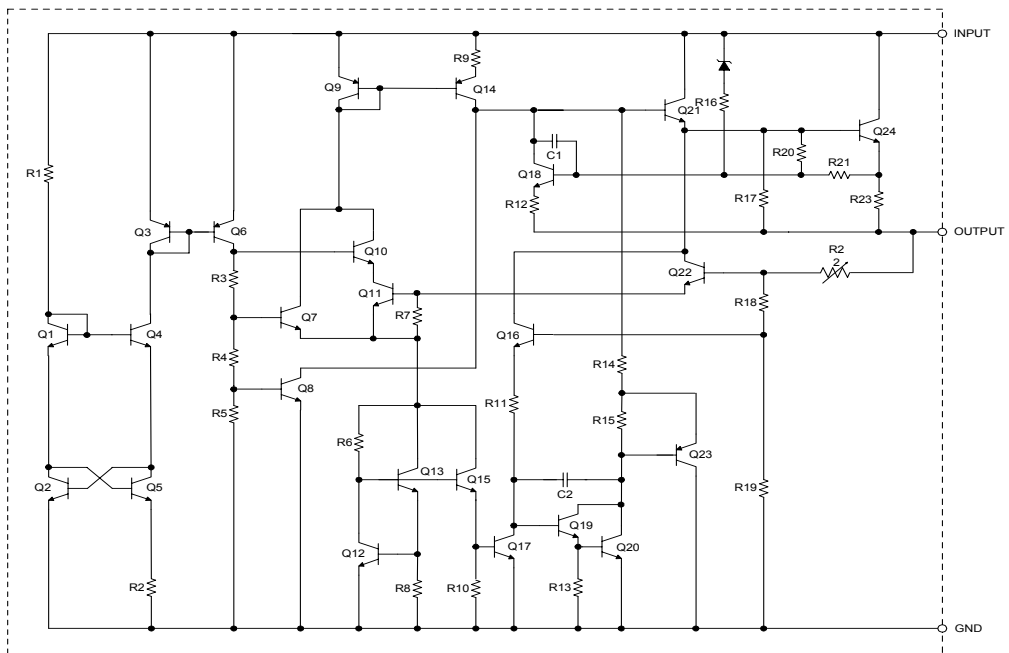

Figure 3. Functional Block Diagram of SP78MXX

Absolute Maximum Ratings (Note 1)

Parameter	Symbol	Value	Unit
Input Voltage	V_{IN}	20	V
Lead Temperature (Soldering, 10 sec.)		300	°C
Power Dissipation	P_D	Internally Limited	
Storage Temperature Range	T_{STG}	-65 to 150	°C
ESD (Machine Model)	ESD	450	V

Note 1: Stresses greater than those listed under "Absolute Maximum Ratings" may cause permanent damage to the device. These are stress ratings only, and functional operation of the device at these or any other conditions beyond those indicated under "Recommended Operating Conditions" is not implied. Exposure to "Absolute Maximum Ratings" for extended periods may affect device reliability.

Recommended Operating Conditions

Parameter	Symbol	Min	Max	Unit
Supply Voltage	V_{CC}	7.5	18	V
Operating Junction Temperature Range	T_J	-40	125	°C

Electrical Characteristics

SP78M05 ($V_{IN}=10V$, $I_{OUT}=350mA$, $T_J=-40^{\circ}C$ to $125^{\circ}C$, $P_D \leq 5W$, unless otherwise noted)

Parameter	Symbol	Conditions	Min	Typ	Max	Unit
Output Voltage	V_{OUT}	$T_J=25^{\circ}C$	4.8	5	5.2	V
		$V_{IN}=7V$ to $15V$, $I_{OUT}=5mA$ to $350mA$	4.75	5	5.25	V
Line Regulation	V_{RLINE}	$T_J=25^{\circ}C$, $V_{IN}=7V$ to $15V$, $I_{OUT}=200mA$		3	50	mV
Load Regulation	V_{RLOAD}	$T_J=25^{\circ}C$, $I_{OUT}=5mA$ to $500mA$		20	100	mV
Quiescent Current	I_Q	$T_J=25^{\circ}C$		3.2	6	mA
Quiescent Current Change	ΔI_Q	$V_{IN}=8V$ to $15V$, $I_{OUT}=200mA$			0.8	mA
		$I_{OUT}=5mA$ to $350mA$			0.5	
Ripple Rejection	$\Delta V_{IN}/\Delta V_{OUT}$	$V_{IN}=8V$ to $15V$, $f=120Hz$, $I_{OUT}=200mA$	62	73		dB
Dropout Voltage	$V_{IN}-V_{OUT}$	$\Delta V_{OUT}=1\%$, $T_J=25^{\circ}C$		2		V
Output Noise Voltage	N_O	$T_A=25^{\circ}C$, $f=10Hz$ to $100KHz$		40		μV
Short Circuit Current	I_{SC}	$T_J=25^{\circ}C$, $V_{IN}=15V$		350		mA
Peak Output Current	I_{PK}	$T_J=25^{\circ}C$		700		mA
Output Voltage Drift	$\Delta V_{OUT}/\Delta T$	$I_{OUT}=5mA$		± 0.2		$mV/^{\circ}C$

SP78M12 ($V_{IN}=17V$, $I_{OUT}=350mA$, $T_J=-40^{\circ}C$ to $125^{\circ}C$, $P_D \leq 5W$, unless otherwise noted)

Parameter	Symbol	Conditions	Min	Typ	Max	Unit
Output Voltage	V_{OUT}	$T_J=25^{\circ}C$	11.5	12	12.5	V
		$V_{IN}=14.5V$ to $17V$, $I_{OUT}=5mA$ to $350mA$	11.4	12	12.6	V
Line Regulation	V_{RLINE}	$T_J=25^{\circ}C$, $V_{IN}=14.5V$ to $17V$, $I_{OUT}=200mA$		8	50	mV
Load Regulation	V_{RLOAD}	$T_J=25^{\circ}C$, $I_{OUT}=5mA$ to $500mA$		25	240	mV
Quiescent Current	I_Q	$T_J=25^{\circ}C$		3.2	6	mA
Quiescent Current Change	ΔI_Q	$V_{IN}=14.5V$ to $17V$, $I_{OUT}=200mA$			0.8	mA
		$I_{OUT}=5mA$ to $350mA$			0.5	
Ripple Rejection	$\Delta V_{IN}/\Delta V_{OUT}$	$V_{IN}=15V$ to $17V$, $f=120Hz$, $I_{OUT}=200mA$	55	60		dB
Dropout Voltage	$V_{IN}-V_{OUT}$	$\Delta V_{OUT}=1\%$, $T_J=25^{\circ}C$		2		V
Output Noise Voltage	N_O	$T_A=25^{\circ}C$, $f=10Hz$ to $100KHz$		75		μV
Short Circuit Current	I_{SC}	$T_J=25^{\circ}C$, $V_{IN}=17V$		350		mA
Peak Output Current	I_{PK}	$T_J=25^{\circ}C$		700		mA
Output Voltage Drift	$\Delta V_{OUT}/\Delta T$	$I_{OUT}=5mA$		± 0.3		$mV/^{\circ}C$

Typical Performance Characteristics

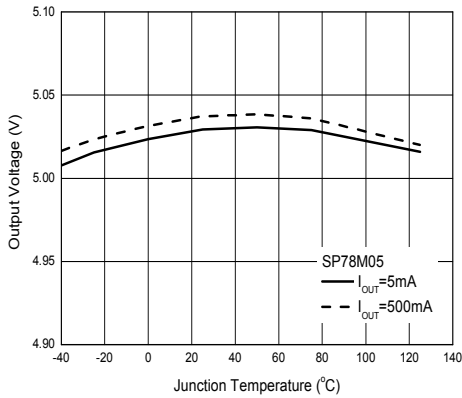

Figure 4. Output Voltage vs. Junction Temperature

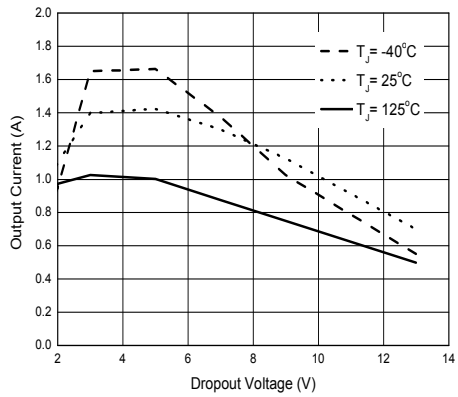

Figure 5. Peak Output Current vs. Dropout Voltage

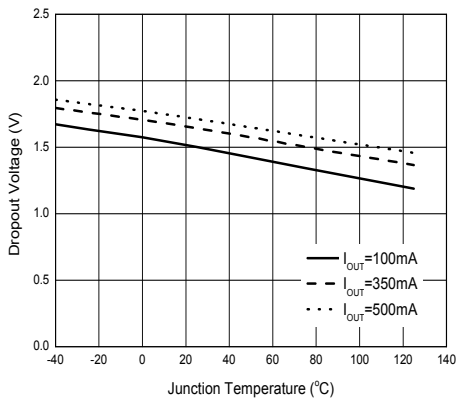

Figure 6. Dropout Voltage vs. Junction Temperature

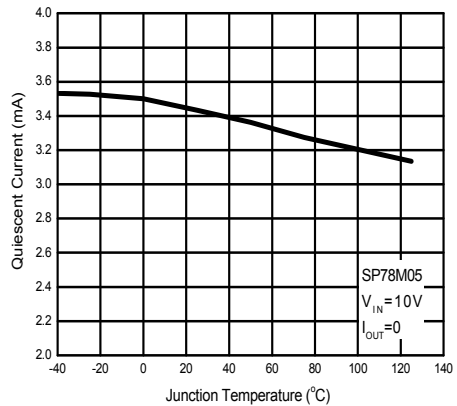

Figure 7. Quiescent Current vs. Junction Temperature

Typical Performance Characteristics (Continued)

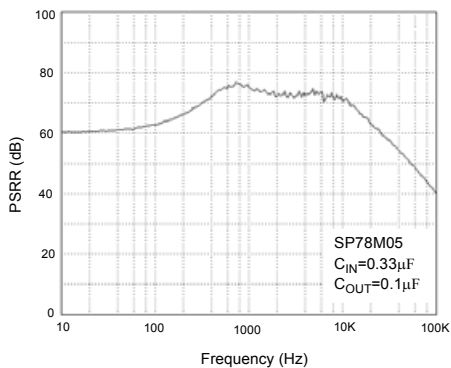

Figure 8. PSRR vs. Frequency

Typical Application

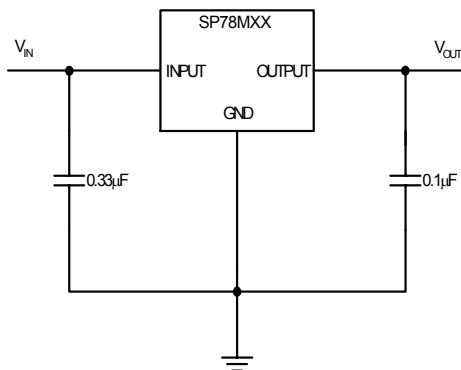
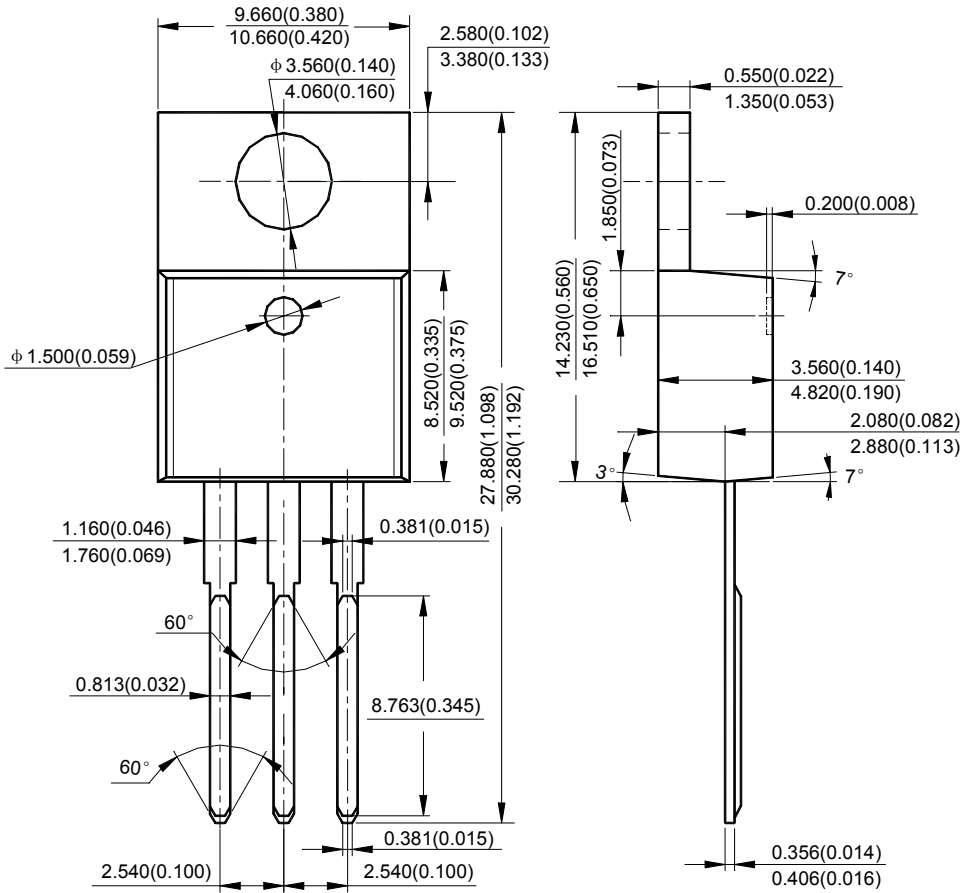

Figure 9. Typical Application of SP78MXX

Mechanical Dimensions

TO-220

Unit: mm(inch)



Mechanical Dimensions (Continued)

TO-252

Unit: mm(inch)

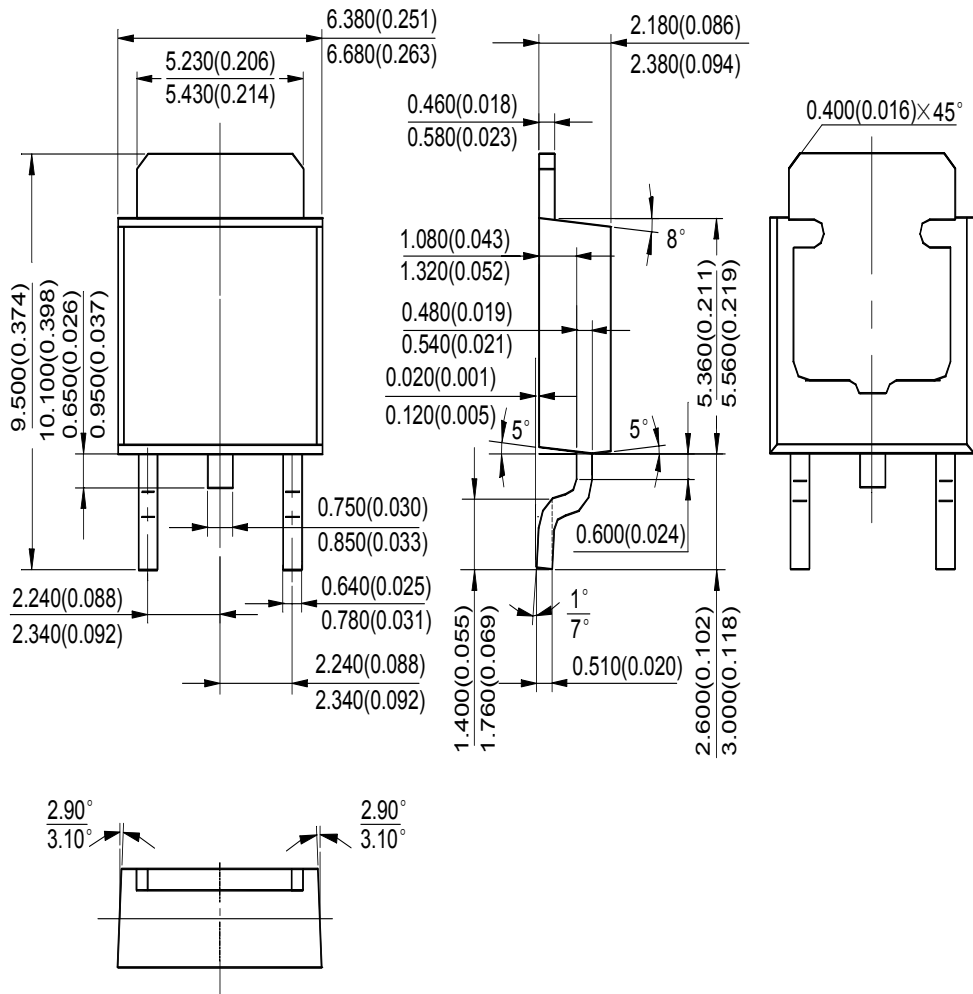

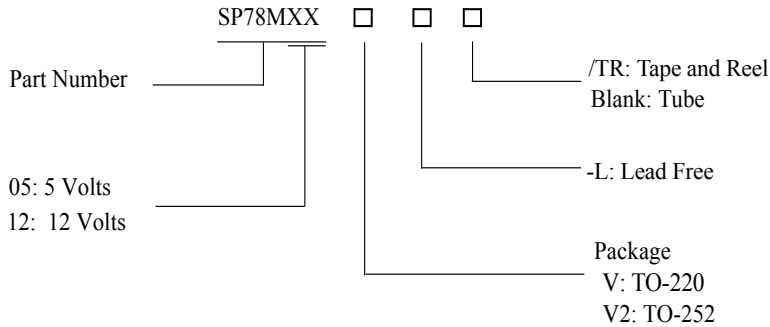

Sipex Corporation's Pb-free products, as designated with "-L" suffix in the part number, are RoHS compliant.

Part Number	Temperature Range	Voltage Tolerance	Output Voltage	Package	Pin Count	Packing Type
SP78M05V-L	-40°C to +125°C	±5%	5V	TO-220	3	50/TUBE
SP78M12V-L	-40°C to +125°C	±5%	12V	TO-220	3	50/TUBE
SP78M05V2-L/TR	-40°C to +125°C	±5%	5V	TO-252	3	2,500/TR
SP78M12V2-L/TR	-40°C to +125°C	±5%	12V	TO-252	3	2,500/TR



Sipex Corporation

Headquarters and Sales Office
 233 South Hillview Drive
 Milpitas, CA 95035
 TEL: (408) 934-7500
 FAX: (408) 935-7600

Sipex Corporation reserves the right to make changes to any products described herein. Sipex does not assume any liability arising out of the application or use of any product or circuit described herein; neither does it convey any license under its patent rights nor the rights of others.