



N-Channel Enhancement Mode Field Effect Transistor

PRODUCT SUMMARY

| V _{DSS} | I _D | R _{DS(ON)} (mΩ) Max |
|------------------|----------------|------------------------------|
| 24V | 12.5A | 4.5 @ V _{GS} =4.5V |
| | | 4.7 @ V _{GS} =4.0V |
| | | 4.9 @ V _{GS} =3.7V |
| | | 5.5 @ V _{GS} =3.1V |
| | | 6.0 @ V _{GS} =2.5V |

FEATURES

- Super high dense cell design for low R_{DS(ON)}.
- Rugged and reliable.
- Surface Mount Package.
- ESD Protected.

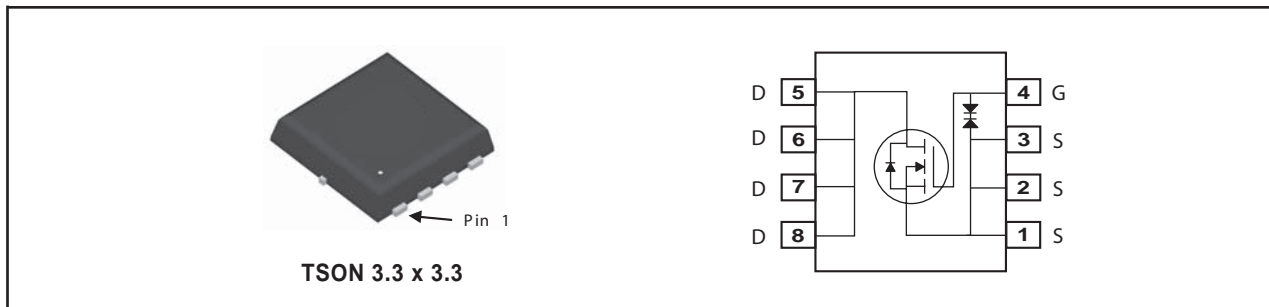

ABSOLUTE MAXIMUM RATINGS (T_A=25°C unless otherwise noted)

| Symbol | Parameter | Limit | Units |
|-----------------------------------|--|----------------------|-------|
| V _{DS} | Drain-Source Voltage | 24 | V |
| V _{GS} | Gate-Source Voltage | ±12 | V |
| I _D | Drain Current-Continuous ^a | T _A =25°C | 12.5 |
| | | T _A =70°C | 10 |
| I _{DM} | -Pulsed ^b | 81 | A |
| P _D | Maximum Power Dissipation ^a | T _A =25°C | 1.67 |
| | | T _A =70°C | 1.07 |
| T _J , T _{STG} | Operating Junction and Storage Temperature Range | -55 to 150 | °C |

THERMAL CHARACTERISTICS

| | | | |
|------------------|--|----|------|
| R _{θJA} | Thermal Resistance, Junction-to-Ambient ^a | 75 | °C/W |
|------------------|--|----|------|

SP8006

Ver 1.1

ELECTRICAL CHARACTERISTICS (T_A=25°C unless otherwise noted)

| Symbol | Parameter | Conditions | Min | Typ | Max | Units |
|---|----------------------------------|---|-----|------|-----|-------|
| OFF CHARACTERISTICS | | | | | | |
| BV _{bss} | Drain-Source Breakdown Voltage | V _{GS} =0V, I _D =250uA | 24 | | | V |
| I _{DSS} | Zero Gate Voltage Drain Current | V _{DS} =20V, V _{GS} =0V | | | 1 | uA |
| I _{GSS} | Gate-Body Leakage Current | V _{GS} = ±12V, V _{DS} =0V | | | ±10 | uA |
| ON CHARACTERISTICS | | | | | | |
| V _{GS(th)} | Gate Threshold Voltage | V _{DS} =V _{GS} , I _D =1.0mA | 0.5 | 0.85 | 1.5 | V |
| R _{DS(ON)} | Drain-Source On-State Resistance | V _{GS} =4.5V, I _D =6.25A | 3.3 | 3.8 | 4.5 | m ohm |
| | | V _{GS} =4.0V, I _D =6.25A | 3.5 | 4.0 | 4.7 | m ohm |
| | | V _{GS} =3.8V, I _D =6.25A | 3.6 | 4.1 | 4.9 | m ohm |
| | | V _{GS} =3.1V, I _D =6.25A | 3.8 | 4.3 | 5.5 | m ohm |
| | | V _{GS} =2.5V, I _D =6.25A | 4.0 | 4.5 | 6.0 | m ohm |
| g _{FS} | Forward Transconductance | V _{DS} =5V, I _D =6.25A | | 39 | | S |
| DYNAMIC CHARACTERISTICS ^c | | | | | | |
| C _{ISS} | Input Capacitance | V _{DS} =10V, V _{GS} =0V f=1.0MHz | | 2400 | | pF |
| C _{OSS} | Output Capacitance | | | 422 | | pF |
| C _{RSS} | Reverse Transfer Capacitance | | | 376 | | pF |
| SWITCHING CHARACTERISTICS ^c | | | | | | |
| t _{D(ON)} | Turn-On Delay Time | V _{DD} =20V I _D =6.25A | | 50 | | ns |
| t _r | Rise Time | | | 139 | | ns |
| t _{D(OFF)} | Turn-Off Delay Time | V _{GS} =4.5V R _{GEN} = 6 ohm | | 110 | | ns |
| t _f | Fall Time | | | 59 | | ns |
| Q _g | Total Gate Charge | V _{DS} =20V, I _D =12.5A, V _{GS} =4.5V | | 24 | | nC |
| Q _{gs} | Gate-Source Charge | | | 4 | | nC |
| Q _{gd} | Gate-Drain Charge | | | 12 | | nC |
| DRAIN-SOURCE DIODE CHARACTERISTICS AND MAXIMUM RATINGS | | | | | | |
| V _{SD} | Diode Forward Voltage | V _{GS} =0V, I _S =12.5A | | 0.82 | 1.2 | V |
| Notes | | | | | | |
| a.Surface Mounted on FR4 Board, t ≤ 10sec. | | | | | | |
| b.Pulse Test:Pulse Width < 10us, Duty Cycle < 1%. | | | | | | |
| c.Guaranteed by design, not subject to production testing. | | | | | | |

Jul,18,2013

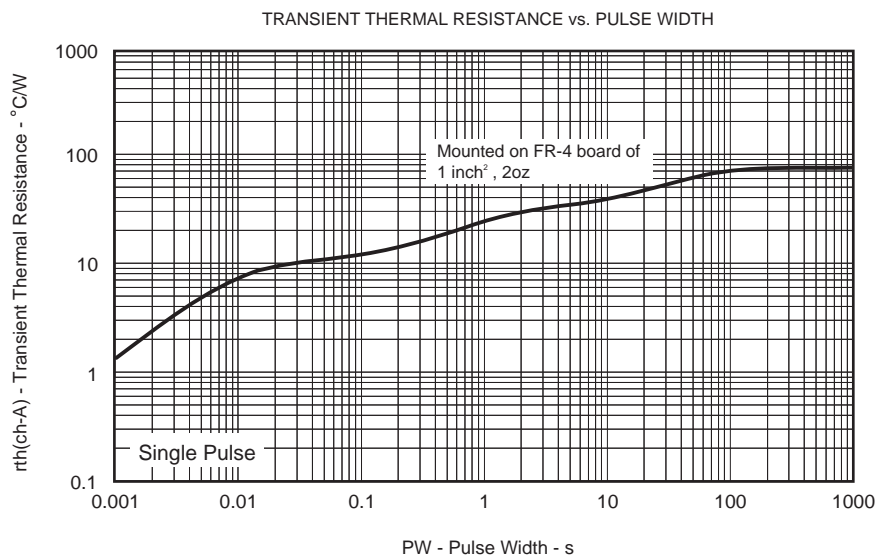
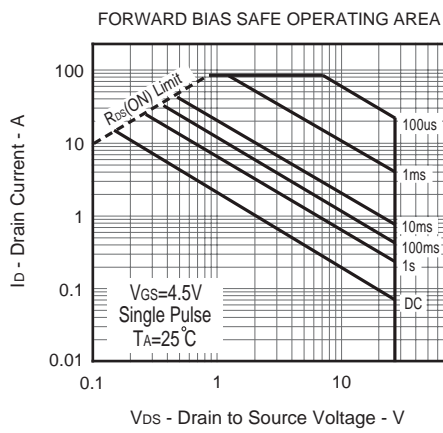
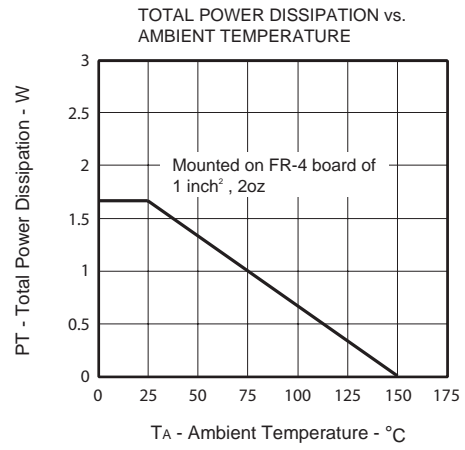
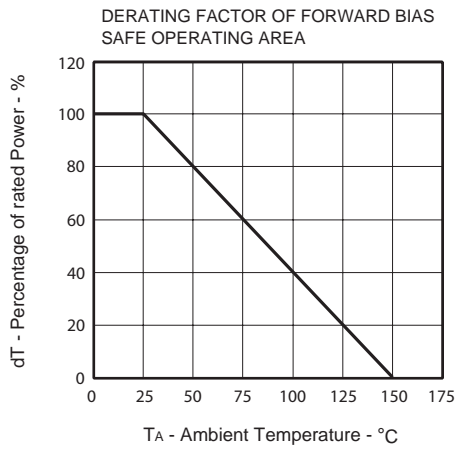

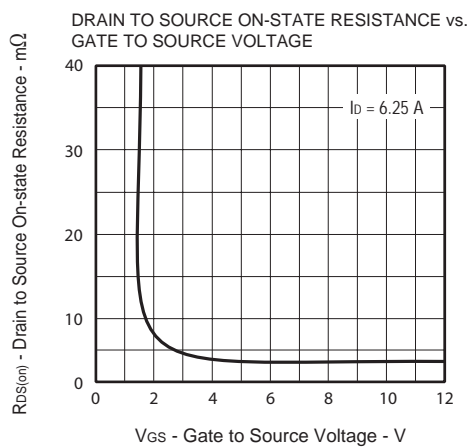
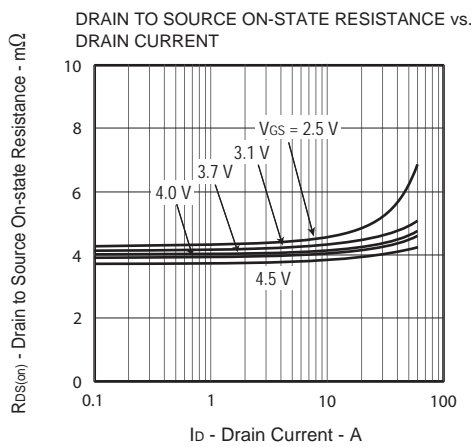
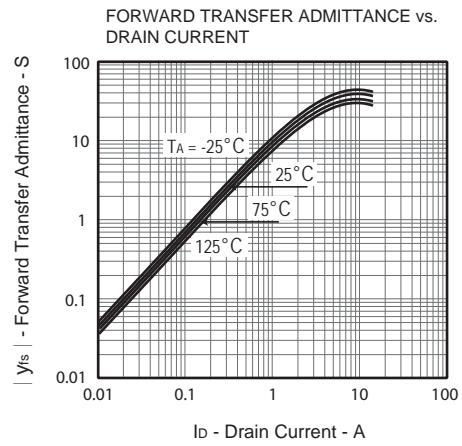
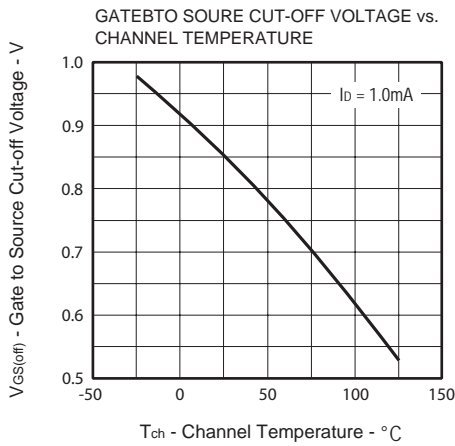
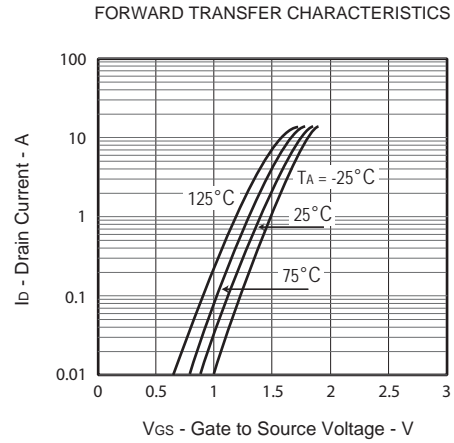
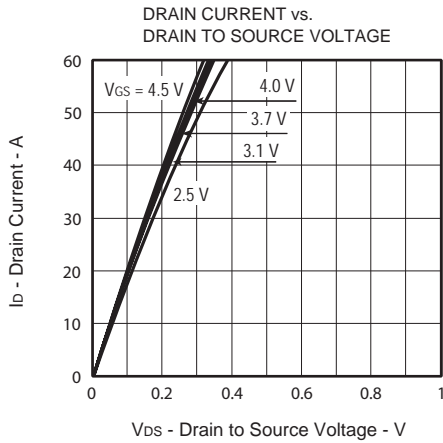

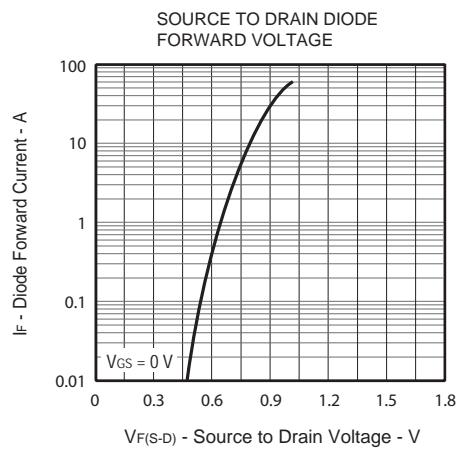
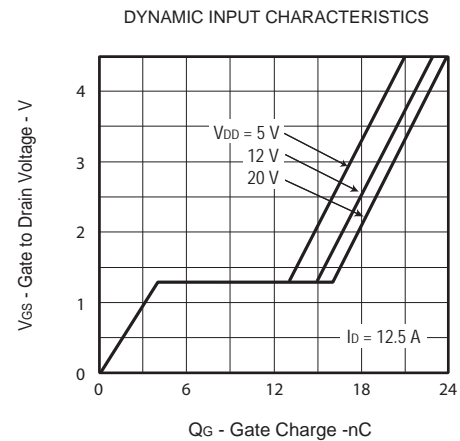
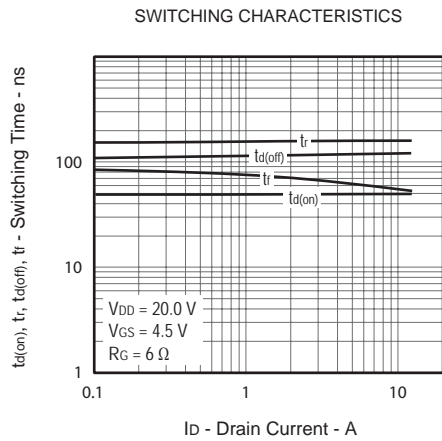
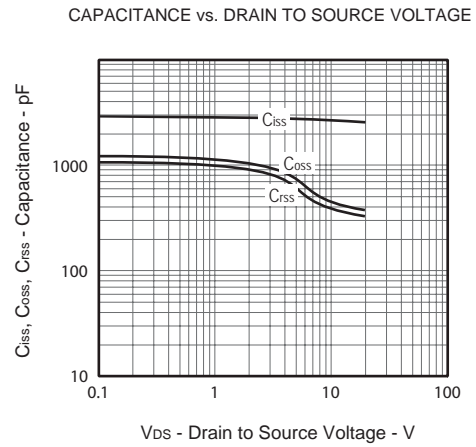
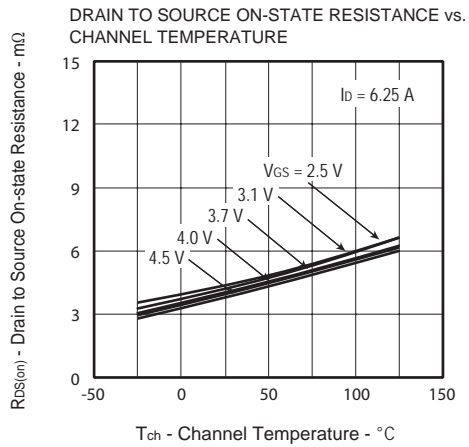

PACKAGE OUTLINE DIMENSIONS

TSON 3.3 x 3.3

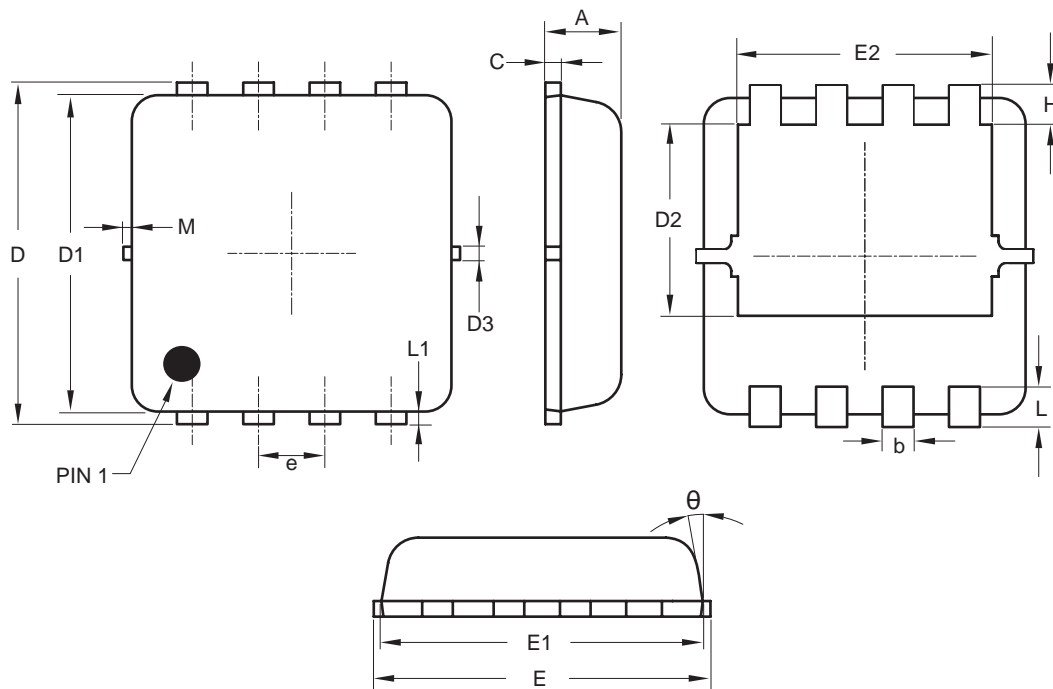

| SYMBOLS | MILLIMETERS | | |
|---------|-------------|------|------|
| | MIN. | NOM. | MAX. |
| A | 0.70 | 0.75 | 0.80 |
| b | 0.25 | 0.30 | 0.35 |
| C | 0.10 | 0.15 | 0.25 |
| D | 3.25 | 3.35 | 3.45 |
| D1 | 3.00 | 3.10 | 3.20 |
| D2 | 1.78 | 1.88 | 1.98 |
| D3 | — | 0.13 | — |
| E | 3.20 | 3.30 | 3.40 |
| E1 | 3.00 | 3.15 | 3.20 |
| E2 | 2.39 | 2.49 | 2.59 |
| e | 0.65 BSC | | |
| H | 0.30 | 0.39 | 0.50 |
| L | 0.30 | 0.40 | 0.50 |
| L1 | — | 0.13 | — |
| M | — | — | 0.15 |
| θ | — | 10° | 12° |

TSON 3.3 x 3.3 Tape and Reel Data

TSON 3.3 x 3.3 Tape

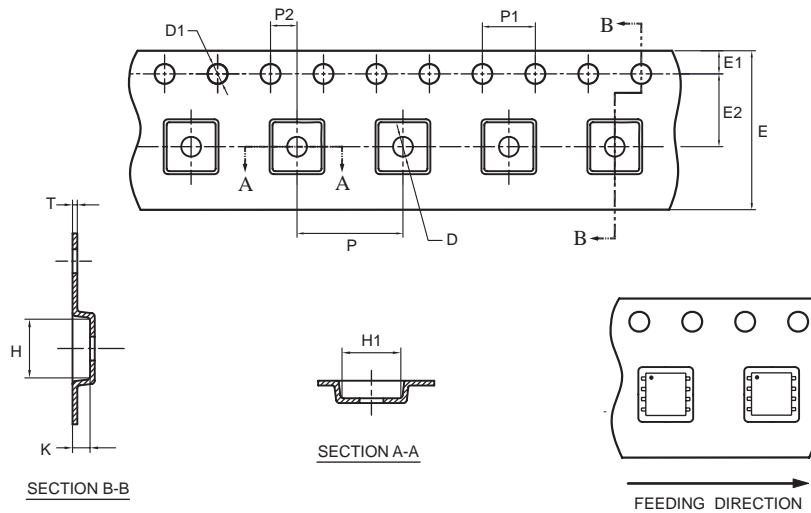

unit:mm

| PACKAGE | D | D1 | E | E1 | E2 | H | H1 | K | P | P1 | P2 | T |
|----------|----------------------|-------------------------------|------------------------|--------------------|--------------------|--------------------|--------------------|--------------------|-------------------|-------------------|-------------------|-------------------|
| S mini 8 | $\phi 1.50$ (MIN) | $\phi 1.50$ +0.10 -0.00 | 12.0 +0.30 -0.10 | 1.75 ± 0.10 | 5.50 ± 0.05 | 3.70 ± 0.10 | 3.70 ± 0.10 | 1.10 ± 0.10 | 8.0 ± 0.10 | 4.0 ± 0.10 | 2.0 ± 0.05 | 0.3 ± 0.05 |

TSON 3.3 x 3.3 Reel

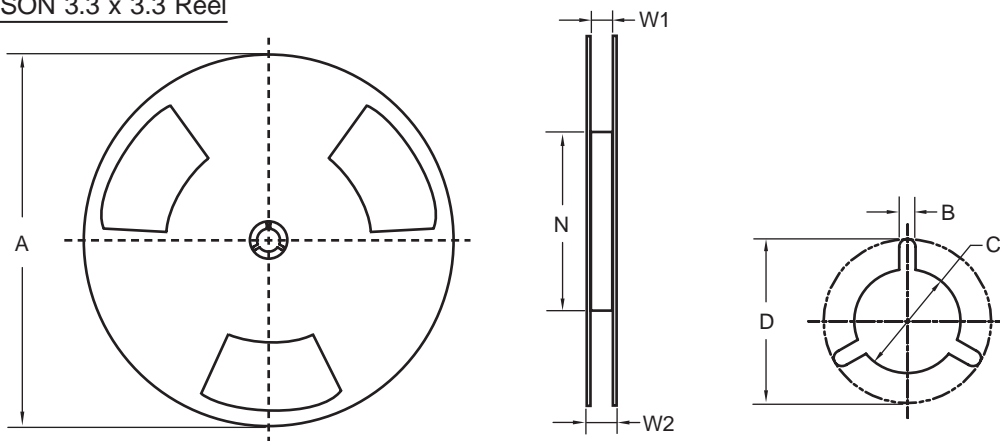

UNIT:mm

| TAPE SIZE | REEL SIZE | A | B | C | D | N | W1 | W2 |
|-----------|-----------|---------------|--|--|------------|--|---|------------|
| 12 mm | 13 " | 330 \pm 1.0 | 1.5 $\begin{smallmatrix} +0.5 \\ -0.2 \end{smallmatrix}$ | $\phi 13.0$ $\begin{smallmatrix} +0.5 \\ -0.2 \end{smallmatrix}$ | 20.2(ref.) | 178 $\begin{smallmatrix} +0.0 \\ -2.0 \end{smallmatrix}$ | 12.4 $\begin{smallmatrix} +2.0 \\ -0.0 \end{smallmatrix}$ | 18.4(ref.) |

TOP MARKING DEFINITION

