



N-Channel Enhancement Mode Field Effect Transistor

PRODUCT SUMMARY

V _{DSS}	I _D	R _{DS(ON)} (mΩ) Typ
30V	28A	3.9 @ V _{GS} =10V
		4.2 @ V _{GS} =4.5V
		5.2 @ V _{GS} =2.5V

FEATURES

- Super high dense cell design for low R_{DS(ON)}.
- Rugged and reliable.
- Surface Mount Package.
- ESD Protected.

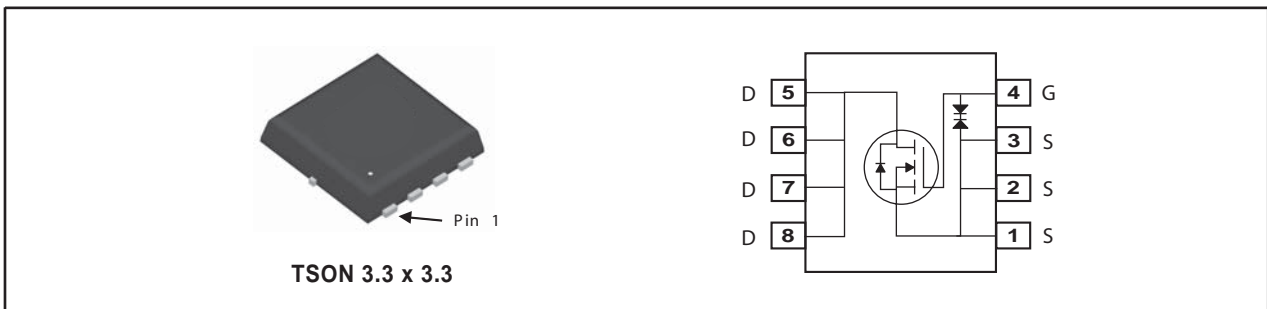

ABSOLUTE MAXIMUM RATINGS (T_A=25°C unless otherwise noted)

Symbol	Parameter	Limit	Units
V _{DS}	Drain-Source Voltage	30	V
V _{GS}	Gate-Source Voltage	±12	V
I _D	Drain Current-Continuous	28	A
I _{DM}	-Pulsed ^a	84	A
E _{AS}	Single Pulse Avalanche Energy ^c	182	mJ
P _D	Maximum Power Dissipation	1.67	W
T _J , T _{STG}	Operating Junction and Storage Temperature Range	-55 to 150	°C

THERMAL CHARACTERISTICS

R _{θ JA}	Thermal Resistance, Junction-to-Ambient	75	°C/W
-------------------	---	----	------

SP8008

Ver 1.0

ELECTRICAL CHARACTERISTICS (T_A=25°C unless otherwise noted)

Symbol	Parameter	Conditions	Min	Typ	Max	Units
OFF CHARACTERISTICS						
BV _{DSS}	Drain-Source Breakdown Voltage	V _{GS} =0V , I _D =250uA	30			V
BV _{Dsx}		V _{GS} =-20V , I _D =10mA	10			V
I _{DSS}	Zero Gate Voltage Drain Current	V _{DS} =30V , V _{GS} =0V			10	uA
I _{GSS}	Gate-Body Leakage Current	V _{GS} = ±12V , V _{DS} =0V			±10	uA
ON CHARACTERISTICS						
V _{GS(th)}	Gate Threshold Voltage	V _{DS} =V _{GS} , I _D =0.2mA	0.5	0.8	1.5	V
R _{DS(ON)}	Drain-Source On-State Resistance	V _{GS} =10V , I _D =14A		3.9	4.9	m ohm
		V _{GS} =4.5V , I _D =14A		4.2	5.5	m ohm
		V _{GS} =2.5V , I _D =14A		5.2	7.0	m ohm
DYNAMIC CHARACTERISTICS ^b						
C _{iss}	Input Capacitance	V _{DS} =10V, V _{GS} =0V f=1.0MHz		2600		pF
C _{oss}	Output Capacitance			520		pF
C _{rSS}	Reverse Transfer Capacitance			445		pF
SWITCHING CHARACTERISTICS ^b						
t _{D(ON)}	Turn-On Delay Time	V _{DD} =15V I _D =14A V _{GS} =10V R _{GEN} = 4.7 ohm		50		ns
t _r	Rise Time			64		ns
t _{D(OFF)}	Turn-Off Delay Time			103		ns
t _f	Fall Time			18		ns
Q _g	Total Gate Charge	V _{DS} =24V, I _D =28A, V _{GS} =10V		47		nC
Q _{gs}	Gate-Source Charge	V _{DS} =24V, I _D =28A, V _{GS} =10V		8.6		nC
Q _{gd}	Gate-Drain Charge			5.5		nC
DRAIN-SOURCE DIODE CHARACTERISTICS AND MAXIMUM RATINGS						
V _{SD}	Diode Forward Voltage	V _{GS} =0V, I _S =28A		0.83	1.3	V
Notes						
a.Pulse Test:Pulse Width < 300us, Duty Cycle < 2%.						
b.Guaranteed by design, not subject to production testing.						
c.Starting T _J =25°C, L=0.5mH, V _{DD} = 20V.						

Aug,13,2013

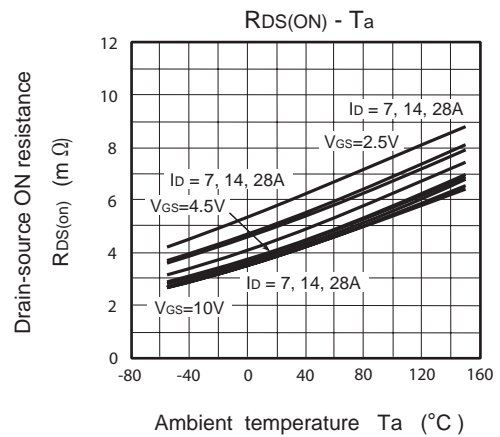
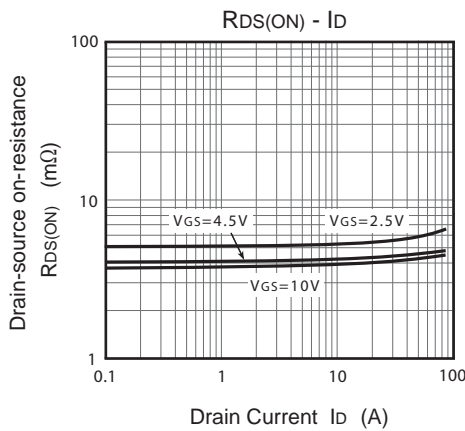
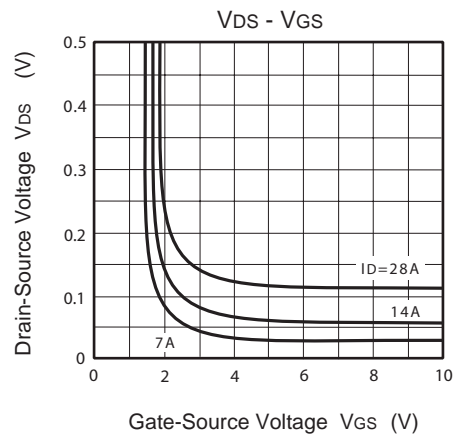
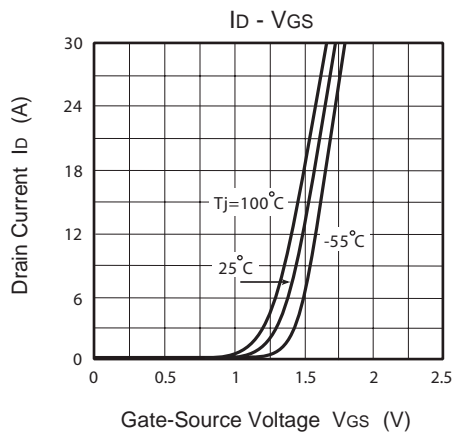
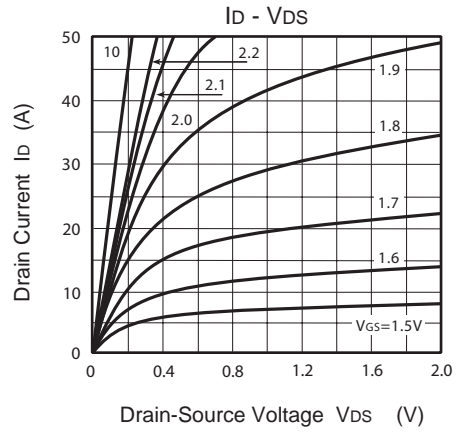
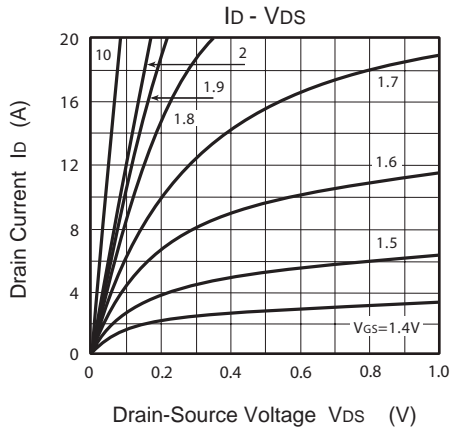

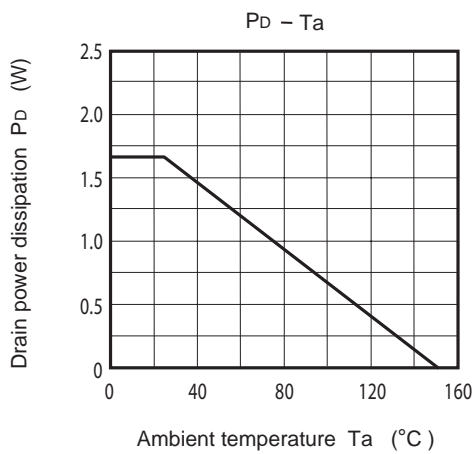
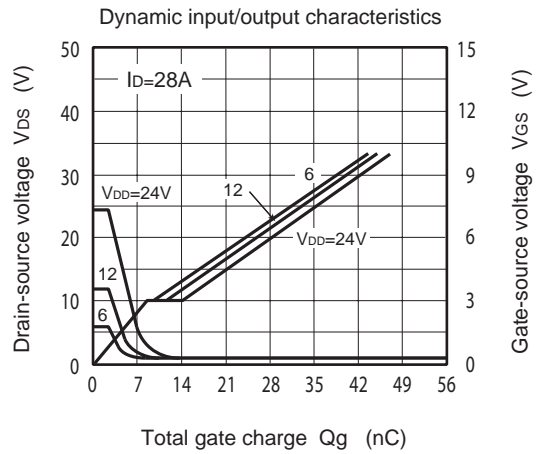
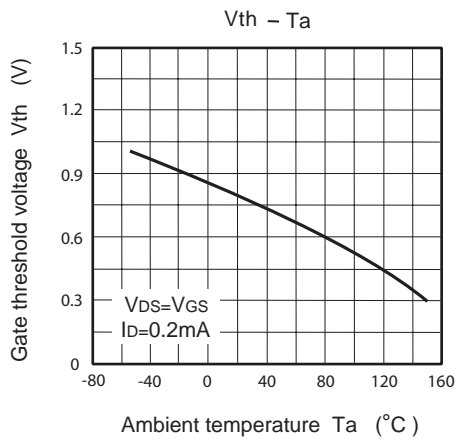
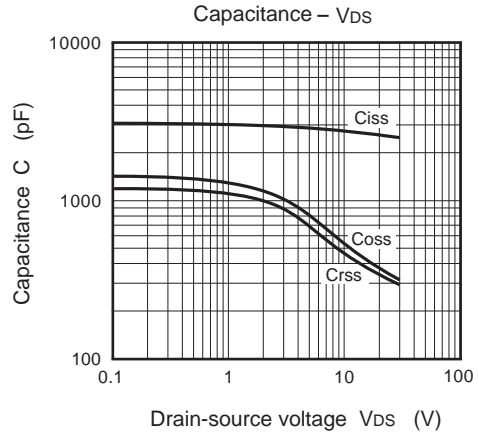
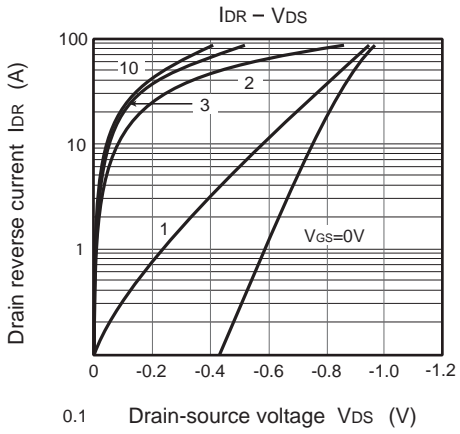

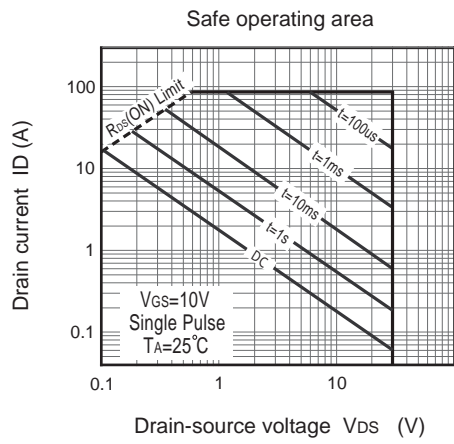
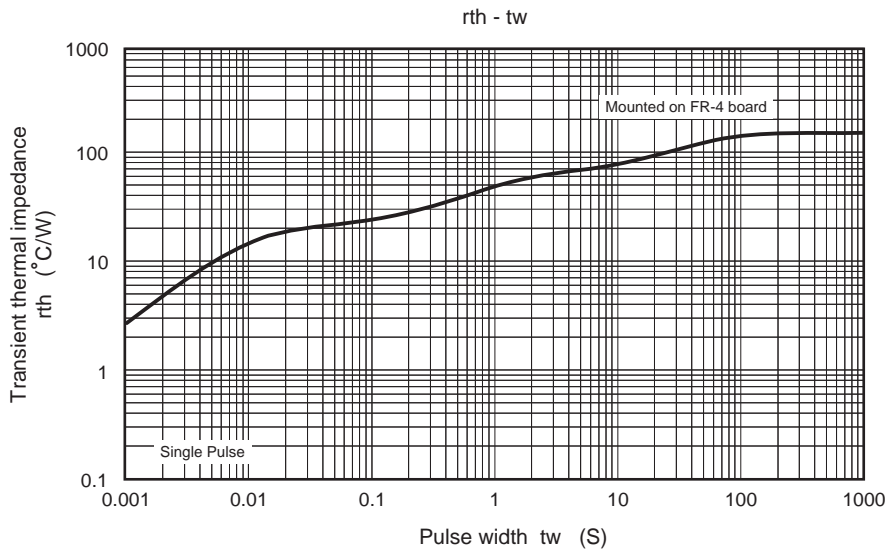

PACKAGE OUTLINE DIMENSIONS

TSON 3.3 x 3.3

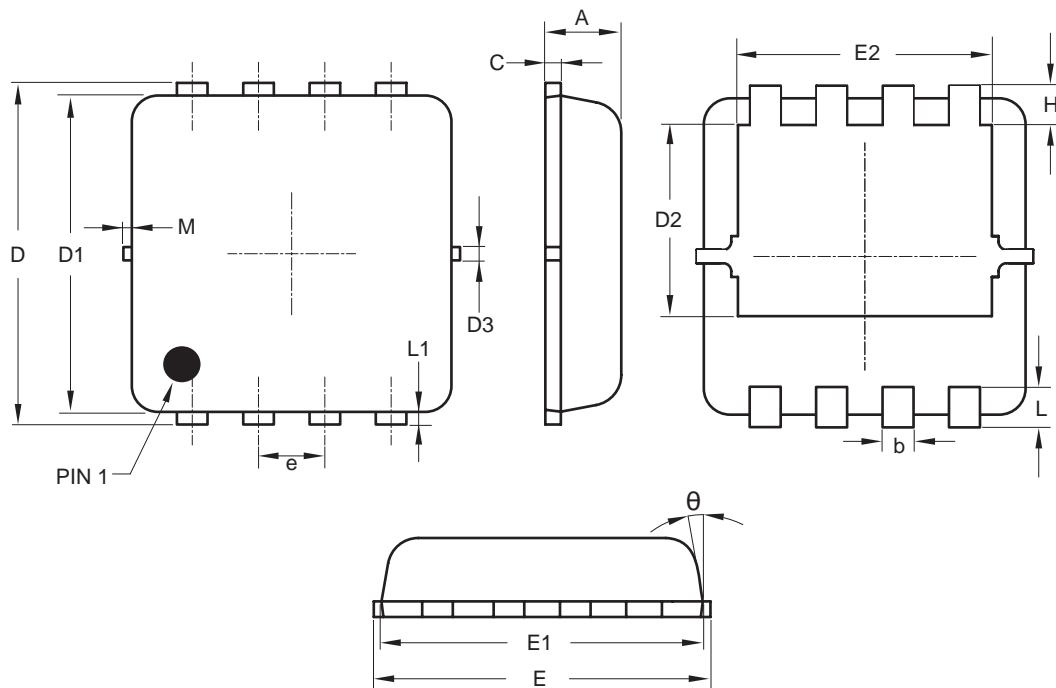

SYMBOLS	MILLIMETERS		
	MIN.	NOM.	MAX.
A	0.70	0.75	0.80
b	0.25	0.30	0.35
C	0.10	0.15	0.25
D	3.25	3.35	3.45
D1	3.00	3.10	3.20
D2	1.78	1.88	1.98
D3	—	0.13	—
E	3.20	3.30	3.40
E1	3.00	3.15	3.20
E2	2.39	2.49	2.59
e	0.65 BSC		
H	0.30	0.39	0.50
L	0.30	0.40	0.50
L1	—	0.13	—
M	—	—	0.15
θ	—	10°	12°

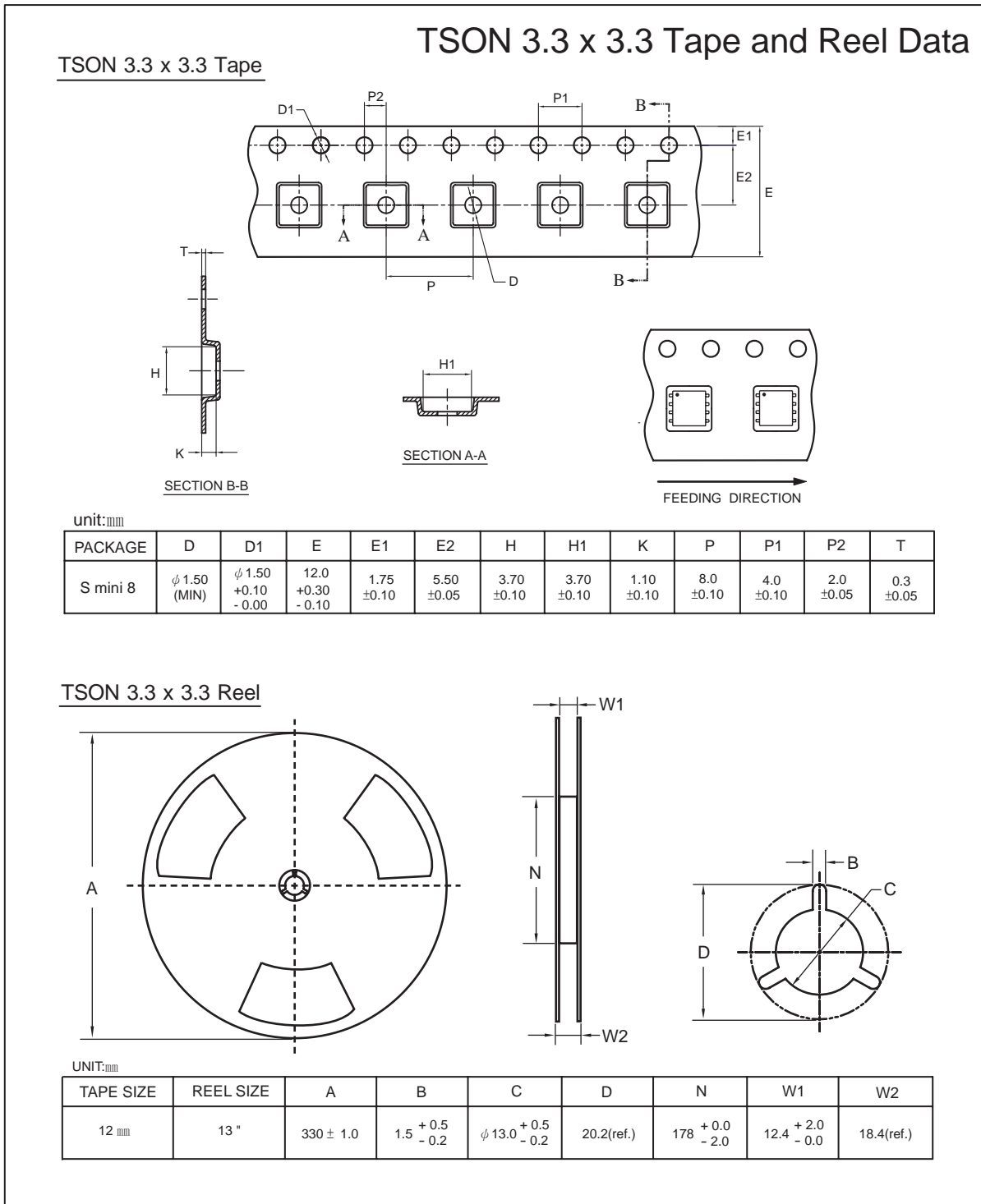

TOP MARKING DEFINITION

