



N-Channel Enhancement Mode Field Effect Transistor

PRODUCT SUMMARY

V _{DSS}	I _D	R _{DS(ON)} (mΩ) Typ
33V	24A	5.0 @ V _{GS} =10V
		6.5 @ V _{GS} =6V

FEATURES

- Super high dense cell design for low R_{DS(ON)}.
- Rugged and reliable.
- Surface Mount Package.
- ESD Protected.

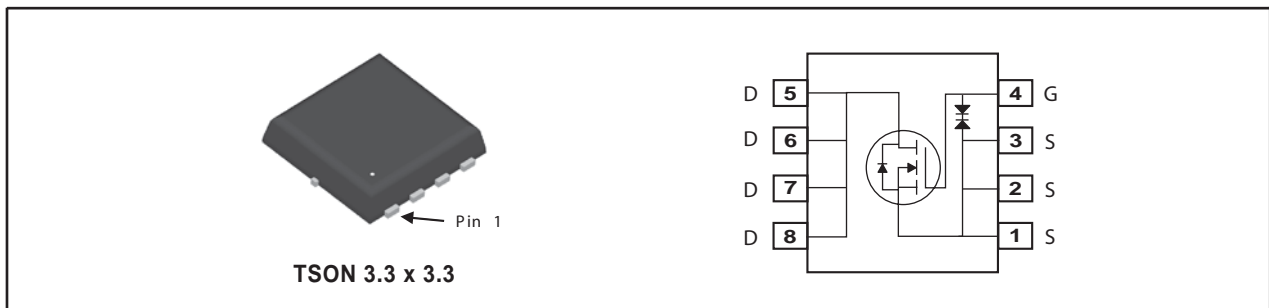

ABSOLUTE MAXIMUM RATINGS (T_A=25°C unless otherwise noted)

Symbol	Parameter	Limit	Units
V _{DS}	Drain-Source Voltage	33	V
V _{GS}	Gate-Source Voltage	±20	V
I _D	Drain Current-Continuous	24	A
I _{DM}	-Pulsed ^a	72	A
P _D	Maximum Power Dissipation	1.67	W
T _J , T _{STG}	Operating Junction and Storage Temperature Range	-55 to 150	°C

THERMAL CHARACTERISTICS

R _{θJA}	Thermal Resistance, Junction-to-Ambient	75	°C/W
------------------	---	----	------

SP8009E

Ver 1.5

ELECTRICAL CHARACTERISTICS (T_A=25°C unless otherwise noted)

Symbol	Parameter	Conditions	Min	Typ	Max	Units
OFF CHARACTERISTICS						
BV _{DSS}	Drain-Source Breakdown Voltage	V _{GS} =0V, I _D =10mA	33			V
BV _{DSX}		V _{GS} =-20V, I _D =10mA	10			V
I _{DSS}	Zero Gate Voltage Drain Current	V _{DS} =33V, V _{GS} =0V			10	uA
I _{GSS}	Gate-Body Leakage Current	V _{GS} = ±20V, V _{DS} =0V			±10	uA
ON CHARACTERISTICS						
V _{GS(th)}	Gate Threshold Voltage	V _{DS} =V _{GS} , I _D =0.2mA	1	1.6	3	V
R _{DS(ON)}	Drain-Source On-State Resistance	V _{GS} =10V, I _D =12A		5.0	6.5	m ohm
		V _{GS} =6V, I _D =12A		6.5	9.0	m ohm
DYNAMIC CHARACTERISTICS^b						
C _{ISS}	Input Capacitance	V _{DS} =10V, V _{GS} =0V f=1.0MHz		1670		pF
C _{OSS}	Output Capacitance			362		pF
C _{RSS}	Reverse Transfer Capacitance			333		pF
SWITCHING CHARACTERISTICS^b						
t _{D(ON)}	Turn-On Delay Time	V _{DD} =15V I _D =12A V _{GS} =10V R _{GEN} = 4.7 ohm		29		ns
t _r	Rise Time			35		ns
t _{D(OFF)}	Turn-Off Delay Time			68		ns
t _f	Fall Time			17		ns
Q _g	Total Gate Charge	V _{DS} =24V, I _D =12A, V _{GS} =10V		29		nC
Q _{gs}	Gate-Source Charge	V _{DS} =24V, I _D =12A, V _{GS} =10V		7		nC
Q _{gd}	Gate-Drain Charge			8		nC
DRAIN-SOURCE DIODE CHARACTERISTICS AND MAXIMUM RATINGS						
V _{SD}	Diode Forward Voltage	V _{GS} =0V, I _S =24A		0.87	1.3	V
Notes						
a.Pulse Test:Pulse Width < 300us, Duty Cycle < 2%.						
b.Guaranteed by design, not subject to production testing.						

Oct,22,2013

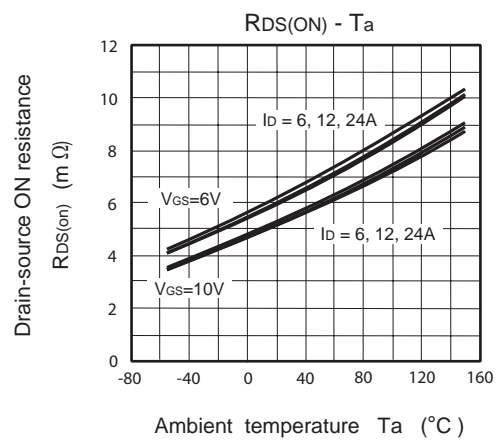
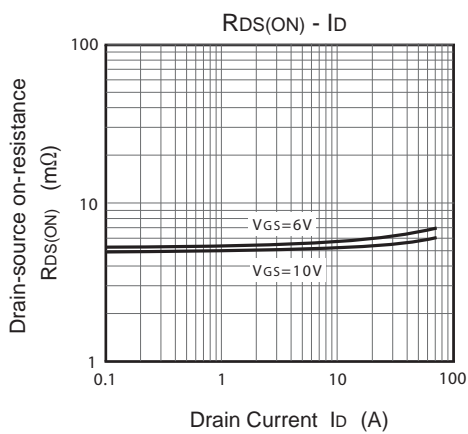
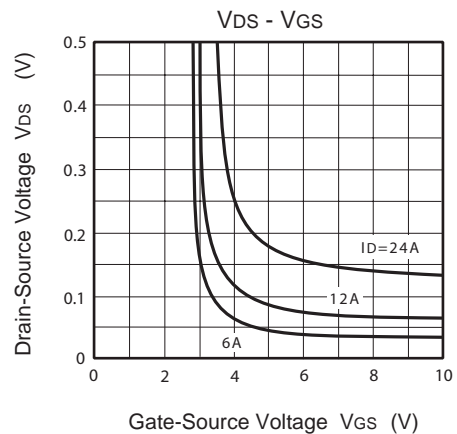
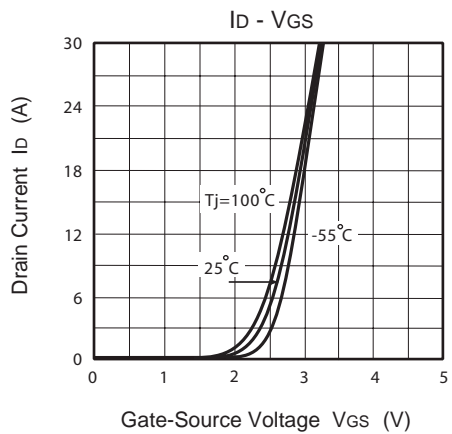
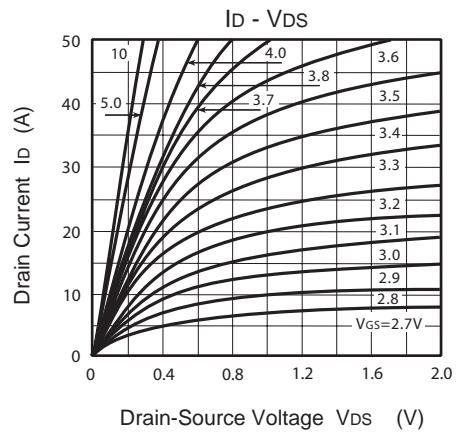
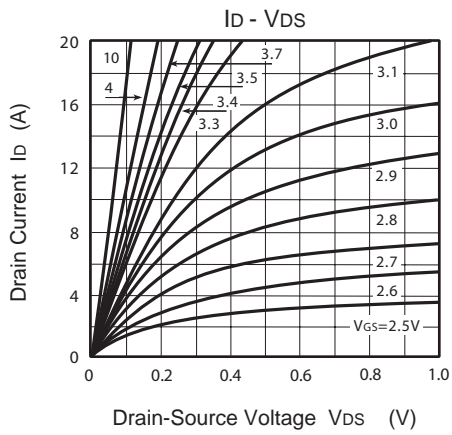

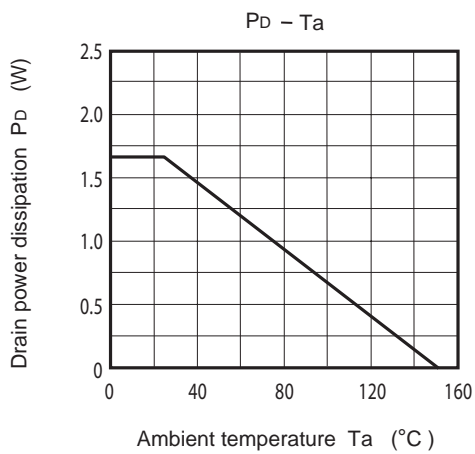
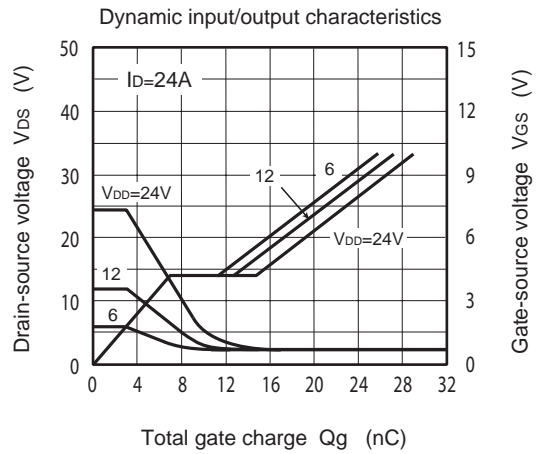
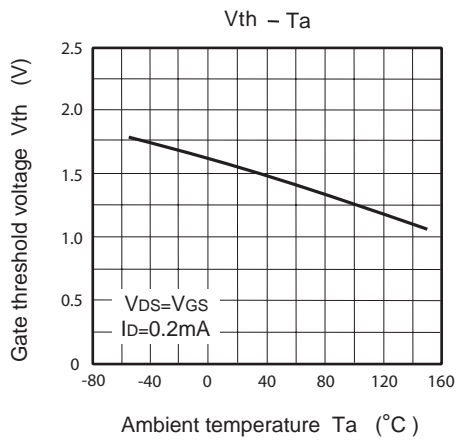
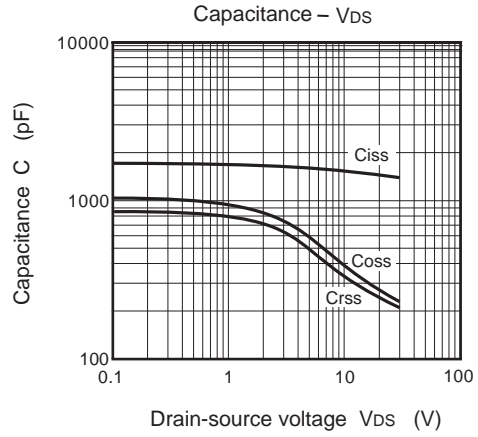
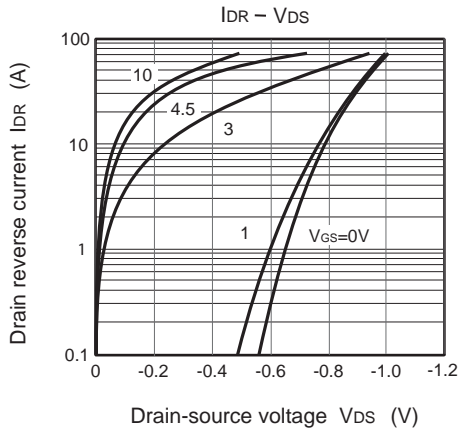

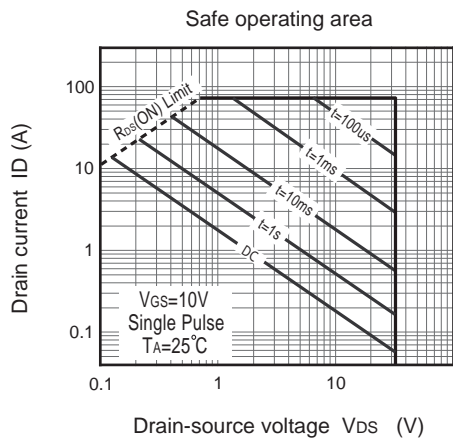
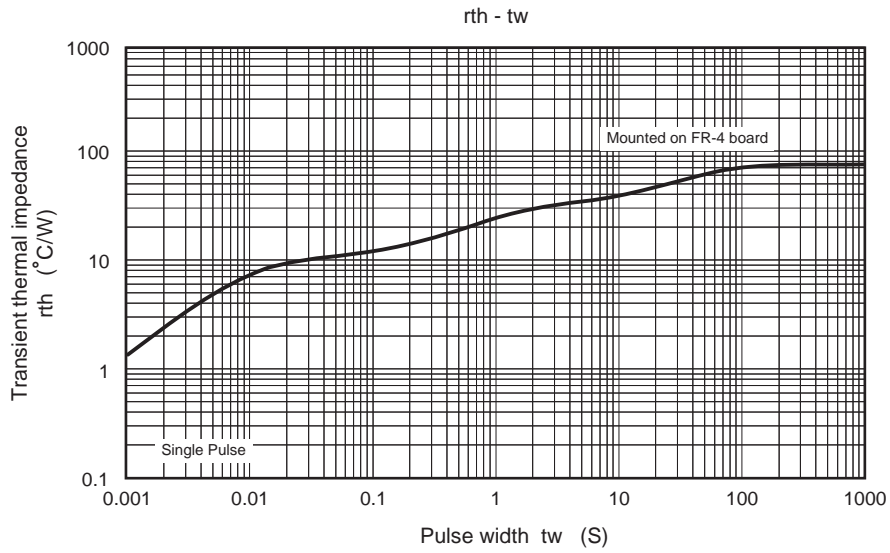

PACKAGE OUTLINE DIMENSIONS

TSON 3.3 x 3.3

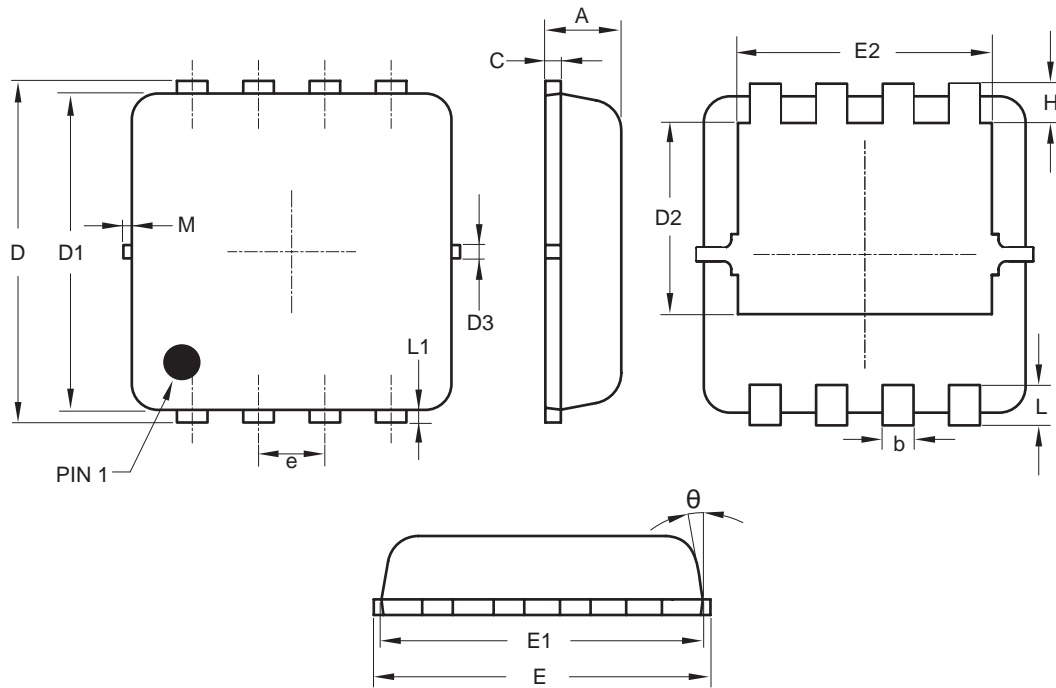

SYMBOLS	MILLIMETERS		
	MIN.	NOM.	MAX.
A	0.70	0.75	0.80
b	0.25	0.30	0.35
C	0.10	0.15	0.25
D	3.25	3.35	3.45
D1	3.00	3.10	3.20
D2	1.78	1.88	1.98
D3	—	0.13	—
E	3.20	3.30	3.40
E1	3.00	3.15	3.20
E2	2.39	2.49	2.59
e	0.65 BSC		
H	0.30	0.39	0.50
L	0.30	0.40	0.50
L1	—	0.13	—
M	—	—	0.15
θ	—	10°	12°

TSON 3.3 x 3.3 Tape and Reel Data

TSON 3.3 x 3.3 Tape

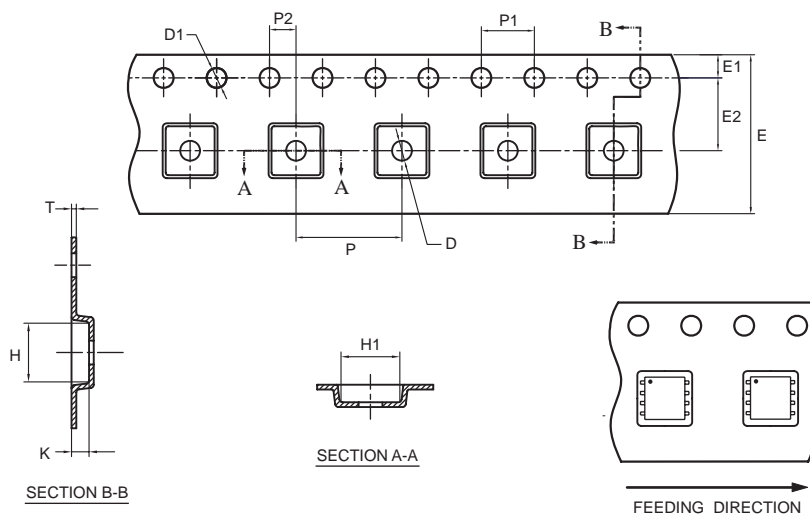

unit : mm

PACKAGE	D	D1	E	E1	E2	H	H1	K	P	P1	P2	T
TSON 3.3 x 3.3	$\phi 1.50$ (MIN)	$\phi 1.50$ +0.10 -0.00	12.0 +0.30 -0.10	1.75 ± 0.10	5.50 ± 0.05	3.70 ± 0.10	3.70 ± 0.10	1.10 ± 0.10	8.0 ± 0.10	4.0 ± 0.10	2.0 ± 0.05	0.3 ± 0.05

TSON 3.3 x 3.3 Reel

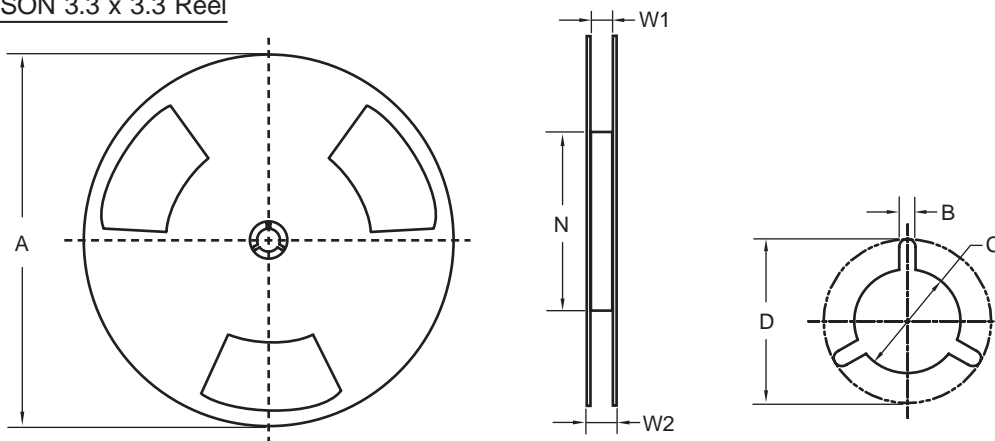

UNIT:mm

TAPE SIZE	REEL SIZE	A	B	C	D	N	W1	W2
12 mm	13 "	330 ± 1.0	1.5 $\begin{matrix} +0.5 \\ -0.2 \end{matrix}$	$\phi 13.0$ $\begin{matrix} +0.5 \\ -0.2 \end{matrix}$	20.2(ref.)	178 $\begin{matrix} +0.0 \\ -2.0 \end{matrix}$	12.4 $\begin{matrix} +2.0 \\ -0.0 \end{matrix}$	18.4(ref.)

TOP MARKING DEFINITION

