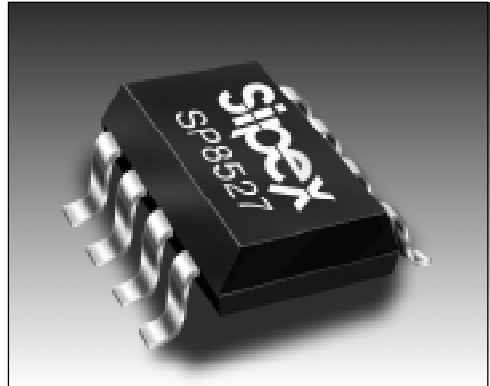


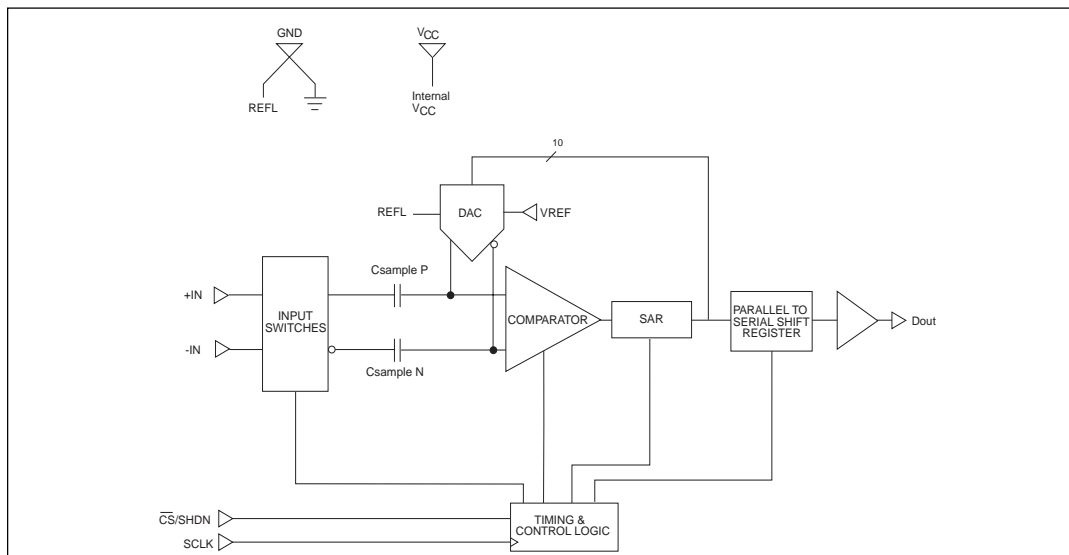
## Micropower Sampling 10-Bit A/D Converter

- Low Cost
- 10-Bit Serial Sampling ADC
- Guaranteed  $\pm 1.0$  LSB Max INL
- 8-Pin NSOIC Plastic Package
- Low Power @ 230 $\mu$ A including Automatic Shutdown: 1nA (typ)
- Full differential input stage
- Single Supply 3.0V to 5.5V operation
- Digital Serial Interface
- Sample Rate: 26.1 $\mu$ S



### DESCRIPTION

The **SP8527** is a very low power 10-Bit A/D converter. The **SP8527** typically draws 230 $\mu$ A of supply current when sampling at 38.3 kHz. Supply current drops linearly as the sample rate is reduced. The ADC automatically powers down when not performing conversions, drawing only leakage current. The **SP8527** is available in 8-Pin NSOIC packages, specified over Commercial and Industrial temperature ranges. The **SP8527** is best suited for Battery-Operated Systems, Portable Data Acquisition Instrumentation, Battery Monitoring, and Remote Sensing applications. The serial port allows efficient data transfer to a wide range of microprocessors and microcontrollers over 3 wires.



**SP8527 Block Diagram**

## ABSOLUTE MAXIMUM RATINGS

These are stress ratings only and functional operation of the device at these ratings or any other above those indicated in the operation sections of the specifications below is not implied. Exposure to absolute maximum rating conditions for extended periods of time may affect reliability.

(TA=+25°C unless otherwise noted) .....	
VCC to GND .....	7.0V
Vin to GND .....	-0.3 to VCC +0.3V
Digital input to GND .....	-0.3 to VCC +0.3V
Digital output to GND .....	-0.3 to VCC +0.3V
Operating Temperature Range	
Commercial (J, K Version) .....	0°C to 70°C
Industrial (A, B Version) .....	-40°C to +85°C
Lead Temperature (Solder 10Sec) .....	+300°C
Storage Temperature .....	-65°C to +150°C
Power Dissipation to 70°C .....	500mW



**CAUTION:**  
ESD (ElectroStatic Discharge) sensitive device. Permanent damage may occur on unconnected devices subject to high energy electrostatic fields. Unused devices must be stored in conductive foam or shunts. Personnel should be properly grounded prior to handling this device. The protective foam should be discharged to the destination socket before devices are removed.

## SPECIFICATIONS

Unless otherwise noted the following specifications apply for VCC=5V or 3.3V with limits applicable for Tmin to Tmax. Typical applies for Ta=25°C.

PARAMETERS	VCC=5.0V			VCC=3.3V			UNITS	CONDITIONS
	MIN.	TYP.	MAX.	MIN.	TYP.	MAX.		
<b>DC ACCURACY</b>								
Resolution		10			10		Bits	
Integral Linearity K,B		±0.5	±1.0		±0.5	±1.0	LSB	
Differential Linearity Error K,B		±0.6	±2.0		±0.6	±2.0	LSB	
Gain Error K,B		±0.2	±2.0		±0.2	±2.0	LSB	
Offset Error K,B		±0.3	±2.0		±0.3	±3.0	LSB	
<b>ANALOG INPUT</b>								
Input Signal FS Range	0		V <sub>ref</sub>	0		V <sub>ref</sub>		
Input Impedance On Channel		20			20		pF	In Parallel with 100MΩ
Off Channel		100			100		MΩ	
		3			3		pF	In Parallel with 100MΩ
		100			100		MΩ	
Input Bias Current		.001	1		.001	1	μA	
Analog Input Range	-0.05		V <sub>CC</sub> +0.05	-0.05		V <sub>CC</sub> +0.05	Volts	
<b>CONVERSION SPEED</b>								
Sample Time		1.5			1.5		clock cycles	See Timing Diagrams
Conversion Time		10			10		clock cycles	See Timing Diagrams
Complete Cycle			38.3			25.5	kHz	See Timing Diagrams
Clock Period	2.0			3.0			μS	See Timing Diagrams
Clock High Time	.9			1.4			μS	See Timing Diagrams
Clock Low Time	.9			1.4			μS	See Timing Diagrams

## SPECIFICATIONS (cont.)

Unless otherwise noted the following specifications apply for V<sub>CC</sub>=5V or 3.3V with limits applicable for T<sub>min</sub> to T<sub>max</sub>. Typical applies for T<sub>a</sub>=25°C.

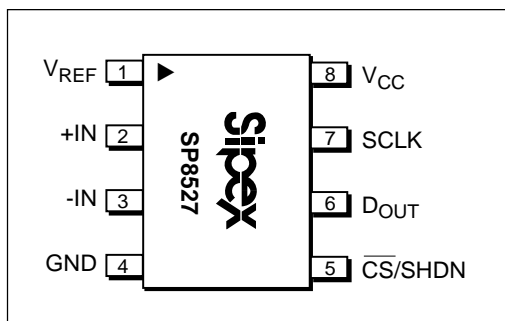
PARAMETERS	V <sub>CC</sub> =5.0V			V <sub>CC</sub> =3.3V			UNITS	CONDITIONS
	MIN.	TYP.	MAX.	MIN.	TYP.	MAX.		
<b>DIGITAL INPUTS</b> Input Low Voltage, V <sub>IL</sub> Input High Voltage, V <sub>IH</sub> Input Current I <sub>IN</sub> Input Capacitance	2.0		0.8 ±2.0	2.0		0.8 ±2.0	Volts Volts µA pF	V <sub>DD</sub> =5V ±5% V <sub>DD</sub> =5V ±5%
<b>DIGITAL OUTPUTS</b> Data Format Data Coding VOH VOL	4.0		0.4	2.0		0.4	Volts Volts	See Timing Diagram V <sub>DD</sub> =5V ±5%, IOH=-0.4mA V <sub>DD</sub> =5V ±5%, IOL=+1.6mA
<b>AC ACCURACY</b> Spurious free Dynamic Range (SFDR)  Total Harmonic Distortion (THD)  Signal to Noise & Distortion (SINAD)  Signal to Noise (SNR)		70		68			dB  dB  dB  dB	For all FFT's (Full Differential Mode) If V <sub>CC</sub> = 5V f <sub>sample</sub> = 38.3kHz f <sub>in</sub> = 15kHz  If V <sub>CC</sub> = 3.3V f <sub>sample</sub> = 25.5kHz f <sub>in</sub> = 12kHz
<b>SAMPLING DYNAMICS</b> Acquisition Time to 0.05%  -3dB Small Signal BW Aperture Delay Aperture Jitter Common-Mode Rejection Ratio		2 4 20 150	3		3 30 150	4.5	µs  MHz nS pS dB	f <sub>CM</sub> = 15kHz @ 5 volts 2.8kHz @ 3.3 volts
<b>POWER SUPPLIES</b> V <sub>CC</sub>  I <sub>CC</sub> Operation Mode  Shutdown Mode  Power Dissipation Operating Mode Shutdown Mode	+3.0	+5.0	+5.5	+3.0	+3.3	+5.5	Volts  µA  µA  mW µW	(CS=0) 38.3kHz, 5V conversion rate. 25.5kHz 3.3 volts  (CS=1)
<b>TEMPERATURE RANGE</b> Commercial Industrial Storage	0° to +70°C -40° to +85°C -65° to +150°C			0° to +70°C -40° to +85°C -65° to +150°C			°C °C °C	

## SPECIFICATIONS (cont.)

### Recommended Operating Conditions

SYMBOL	PARAMETERS	VCC=5.0V			VCC=3.3V			UNITS
		MIN.	TYP.	MAX.	MIN.	TYP.	MAX.	
V <sub>CC</sub>	Supply Voltage	+3.0	+5.0	+5.5	+3.0	+3.3	+5.5	Volts
f <sub>CLK</sub>	Clock Frequency			500			333	kHz
t <sub>CYC</sub>	Total Cycle Time	26.1			39.2			μS
t <sub>SUCS</sub>	Setup Time CSv Before CLK <sup>^</sup>	100			150			nS
t <sub>WHCLK</sub>	CLK High Time	.9			1.4			μS
t <sub>WLCLK</sub>	CLK Low Time	.9			1.4			μS
t <sub>WHCS</sub>	$\overline{\text{CS}}$ High Time between Data Transfers Cycles	100			150			nS
t <sub>SAMPLE</sub>	S/H Acquisition Time		2			2		SCLK Cycles
t <sub>CONV</sub>	ADC Conversion Time		10			10		SCLK Cycles
t <sub>CLK</sub>	Clock Period	2.0			3.0			μS
t <sub>en</sub>	SCLK $\overline{\downarrow}$ to D <sub>OUT</sub> Enable		80	200		150	300	nS
t <sub>DIS</sub>	CSN $\overline{\uparrow}$ to D <sub>OUT</sub> Hi - Z		80	200		150	200	nS
t <sub>R</sub>	D <sub>OUT</sub> Rise Time		5	25		10	50	nS
t <sub>F</sub>	D <sub>OUT</sub> Fall Time		5	25		10	50	nS
t <sub>HDO</sub>	D <sub>OUT</sub> Valid After SCLK $\overline{\downarrow}$		80	200		150	300	nS

### PIN DESCRIPTION



### PIN ASSIGNMENTS

Pin 1- V<sub>REF</sub> - Reference Voltage

Pin 2- +IN - Positive Input

Pin 3- -IN - Negative Input

Pin 4- GND - Ground

Pin 5-  $\overline{\text{CS}}$ /SHDN - Chip Select Bar/Shutdown

Pin 6 - D<sub>OUT</sub> - Data Out

Pin 7- SCLK - Serial Clock

Pin 8- V<sub>CC</sub> - Supply

## DESCRIPTION

The **SP8527** is a 10 bit full differential sampling ADC with a serial data interface. The ADC samples and converts 10 bits of data in 26.1  $\mu\text{S}$  with a 5V supply voltage applied. The **SP8527** will also operate at a 3.3V supply at 39.2  $\mu\text{S}$  throughput. The device automatically shuts down to a  $\pm 0.5 \mu\text{A}$  (MAX) level as soon as the chip is deselected ( $\overline{\text{CS}}=1$ ). Serial data output is available in an MSB first format.

## FEATURES

The input sampling scheme is full differential, where the maximum full scale range is  $V_{\text{REF}}$ . The signal is applied between +IN and -IN. The signals applied at each input may both be dynamic. This is in contrast with pseudo differential devices which must have input low held at a constant level during conversion. The converter will provide significant common mode rejection because of the full differential sampling. Each input independently must remain between ground and Vcc to avoid clamping the inputs. For proper conversion the differential input (+IN - -IN) must be less than or equal to Vref.

The device uses a capacitive DAC architecture which provides the sampling behavior. This results in full Nyquist performance at the fastest throughput rate (38.3kHz) the device is capable of.

The power supply voltage is variable from 3.0V to 5.5V which provides supply flexibility. At the 5.0V supply level, conversion plus sampling time is 26.1  $\mu\text{S}$  and supply current is 230  $\mu\text{A}$  (1.15 mW). With a 3.3V supply the conversion plus sampling time is 39.2  $\mu\text{S}$  and current is reduced to 80  $\mu\text{A}$  (0.26 mW).

## ADC TRANSFER FUNCTION

INPUT VOLTAGE (+IN - -IN)	INPUT VOLTAGE AT $V_{\text{REF}} = 5\text{V}$	OUTPUT CODE
0 LSB	0V	000000000
1 LSB	0.0049V	000000001
512 LSB	2.5000V	100000000
1022 LSB	4.9902V	111111110
1023 LSB	4.9951V	111111111

The device features automatic shutdown and will shutdown to a  $\pm 0.5 \mu\text{A}$  power level as  $\overline{\text{CS}}$  is brought high (de-selected). Power is proportional to conversion duty cycle and varies from 230  $\mu\text{A}$  at 26.1  $\mu\text{S}$  (Duty cycle = 100%) to 5.75  $\mu\text{A}$  at 1.04 ms (Duty cycle = 2.5%).

## Examples:

Conversion rate	$I_{\text{CC}} @ 5\text{V}$	Duty Cycle
26.1 $\mu\text{S}$	230 $\mu\text{A}$	100%
52.2 $\mu\text{S}$	115 $\mu\text{A}$	50%
104 $\mu\text{S}$	57.5 $\mu\text{A}$	25%
1.04 ms	5.75 $\mu\text{A}$	2.5%

The device is configured such that it delivers serial data MSB first requiring 13 clock periods for a full conversion. Please refer to the timing diagram.

## Circuit Operation

The **SP8527** is a SAR converter with full differential sampled front end, capacitive DAC, precision comparator, Successive Approximations Register, control logic and data output register. After the input is sampled and held the conversion process begins. The DAC MSB is set and its output is compared with the signal input, if the DAC output is less than the input, the comparator outputs a one which is latched into the SAR and simultaneously made available at the ADC serial output pin. Each bit is tested in a similar manner until the SAR contains a code which represents the signal input to within  $\pm 1/2$  LSB. During this process the SAR content has been shifted out of the ADC serially. The data appears at the DOUT pin MSB through LSB in 13 clock periods. Note that the Chip Select Bar pin must be toggled high between conversions. The DOUT pin will be in a high impedance state whenever Chip Select Bar is high. After Chip Select Bar has been toggled and brought low again, the converter begins a new conversion.

## Single Ended or Full Differential Operation

The **SP8527** has a balanced full differential front end. The **SP8527** can be used in this manner, or it can be used in single-ended circuits as well. For single-ended systems, simply tie the -IN to the Reference Low of the input signal, which is allowed to range from 0V to  $V_{CC}$ . For a full differential sampling configuration, both inputs are sampled and held simultaneously. Because of the balanced differential sampling, dynamic common mode noise riding along the input signal is cancelled above and beyond DC noise. This is a significant improvement over pseudo-differential sampling schemes, where the low side of the input must remain constant during the conversion, and therefore only DC noise (i.e. signal offset) is cancelled. If AC common mode noise is left to be converted along with the differential component, the output signal will be degraded.

Full differential sampling allows flexibility in converting the input signal. If the signal low- side is already tied to a ground elsewhere in the system, it can be hardwired to the low side input (i.e., -IN) which acts as a signal ground sense, breaking a potential ground loop. It is also possible to drive the inputs balanced differential, as long as both inputs are within the power rails. In this configuration, both the high and low signals have the same impedance looking back to ground, and therefore pick up the same noise along the physical path from signal source (i.e., sensor, transducer, battery) to the converter. This noise becomes common mode, and is cancelled out by the differential sampling of the **SP8527**.

### Layout Considerations

To preserve the high resolution and linearity of the **SP8527** attention must be given to circuit board layout, ground impedance and bypassing.

A circuit board layout which includes separate analog and digital ground planes will prevent the coupling of noise into sensitive converter circuits and will help to preserve the dynamic performance of the device. In single ended mode, the analog input signal should be

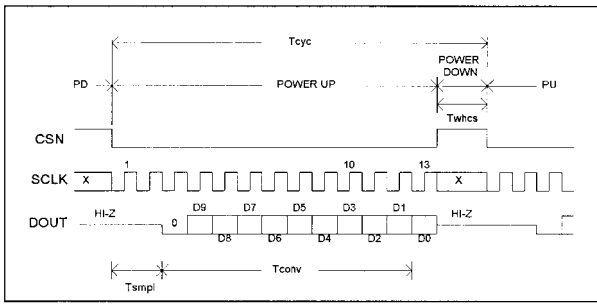
referenced to the ground pin of the converter. This prevents any voltage drops that occur in the power supply's common return from appearing in series with the input signal.

In full differential mode, the high and low side board traces should run close to each other, with the same layout. This will insure that any noise coupling will be common mode, and cancelled by the converters (patent pending) full differential architecture.

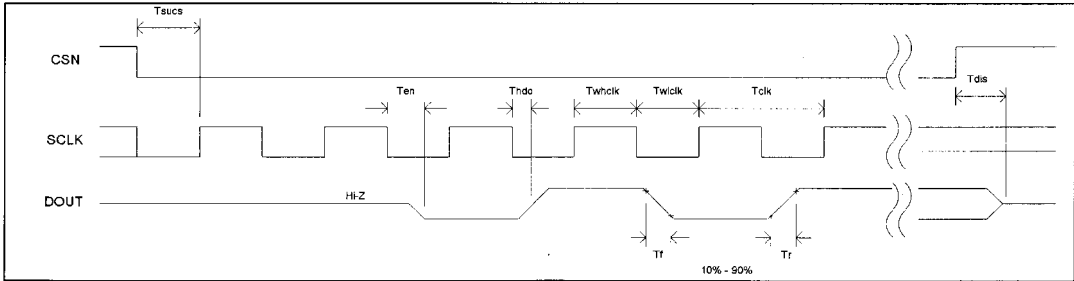
If separate analog and digital ground planes are not possible, care should be used to prevent coupling between analog and digital signals. If analog and digital lines must cross, they should do so at right angles. Parallel analog and digital lines should be separated by a circuit board trace which is connected to common.

The reference pin on the **SP8527** should be kept as clean as possible. A noise signal of 4.88mV (for  $V_{REF} = 5.0V$ ) will produce 1 lsb of error in the output code. For convenience, the  $V_{REF}$  pin can be tied to the VCC pin, but now the same care should be taken with the VCC pin as with the  $V_{REF}$  pin. Whether or not VCC is tied to  $V_{REF}$ , the VCC pin should always be bypassed to the GROUND pin with a parallel combination of a 6.8 $\mu$ F tantalum and a 0.1 $\mu$ F ceramic capacitor. To maintain maximum system accuracy, the supply connected to the VCC pin should be well isolated from digital supplies and wide load variations. A separate conductor from the supply regulator to the A/D converter will limit the effects of digital switching elsewhere in the system. Power supply noise can degrade the converters performance. Especially corrupting are noise and spikes from a switching power supply.

To avoid introducing distortion when driving the A/D converter input, the input signal source should be able to charge the **SP8527**'s equivalent 20 pF of input capacitance from zero volts to the signal level in 1.5 clock periods.

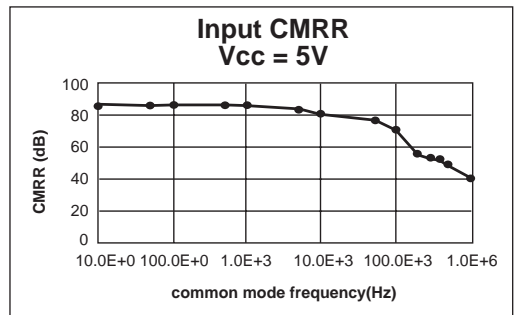
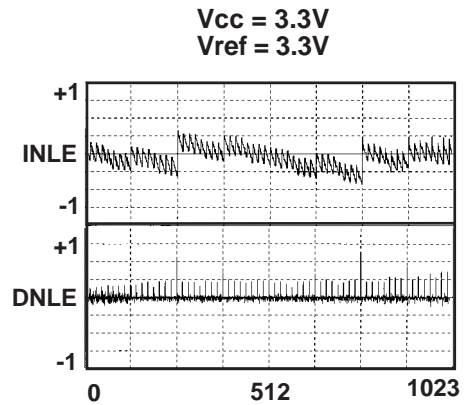
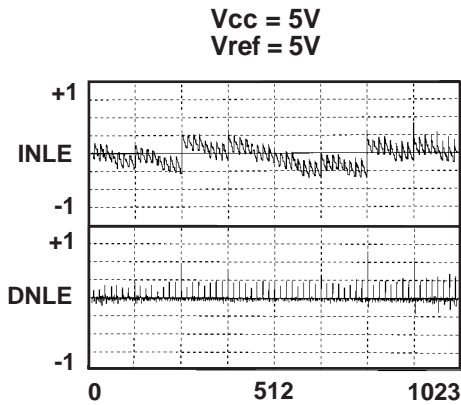
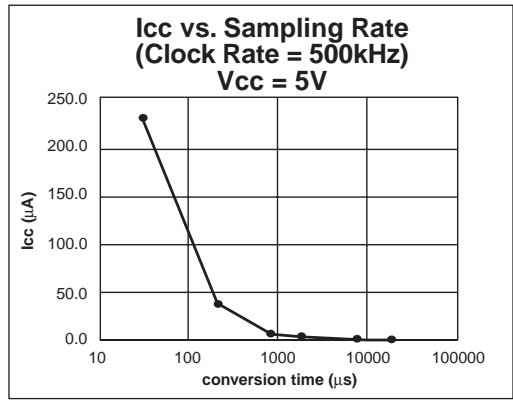
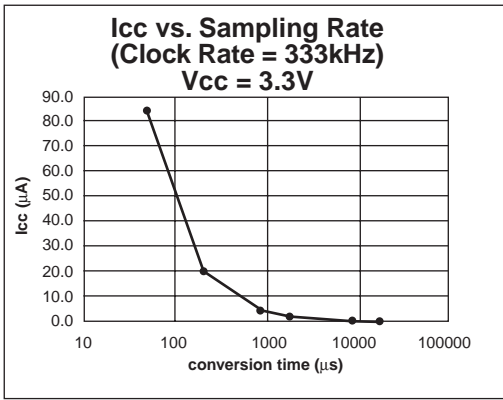


**FIGURE 1. MSB FIRST TIMING**



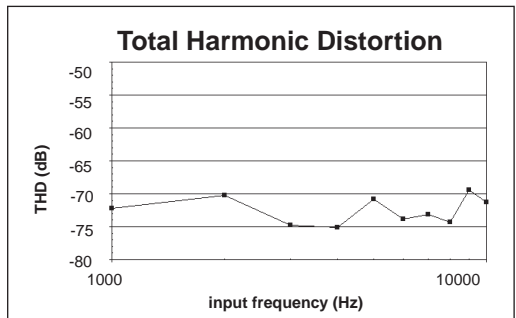
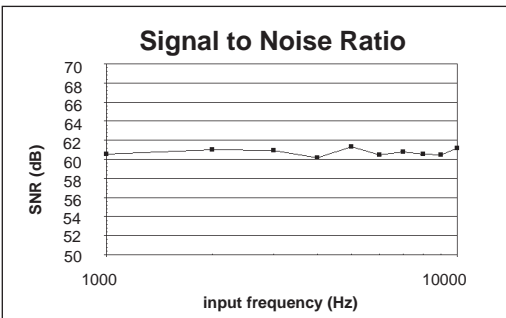
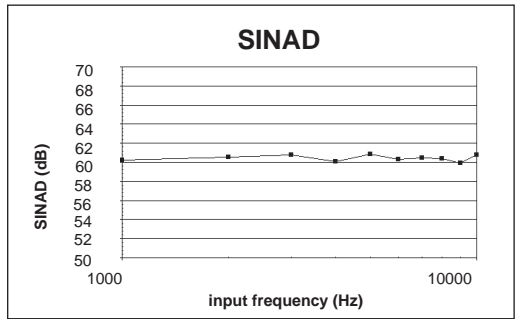
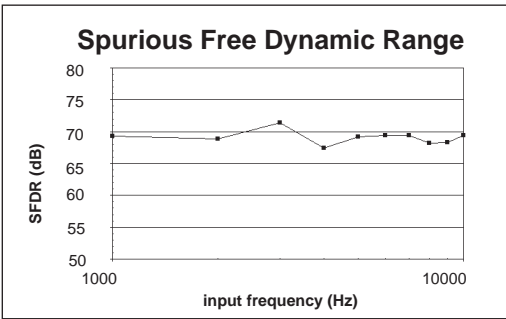
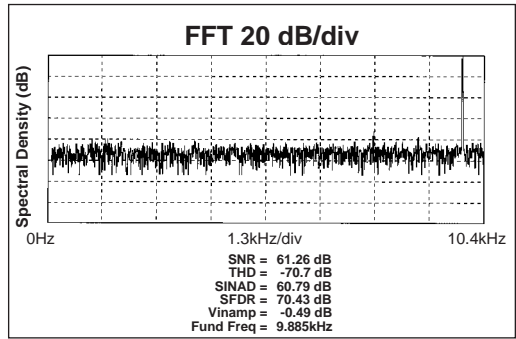
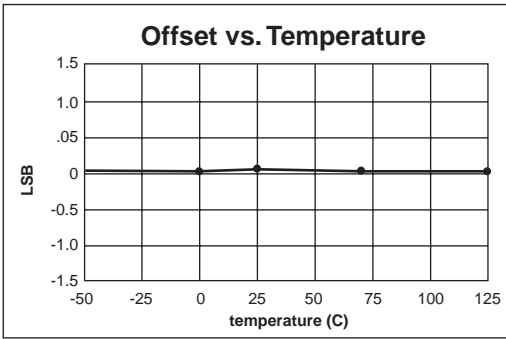
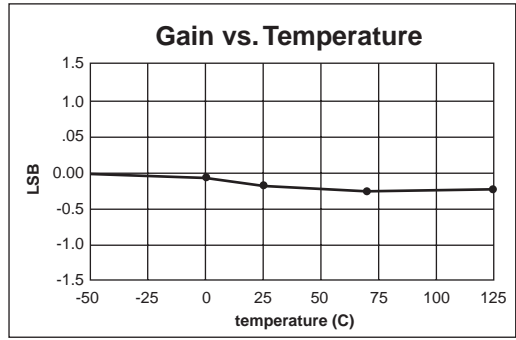
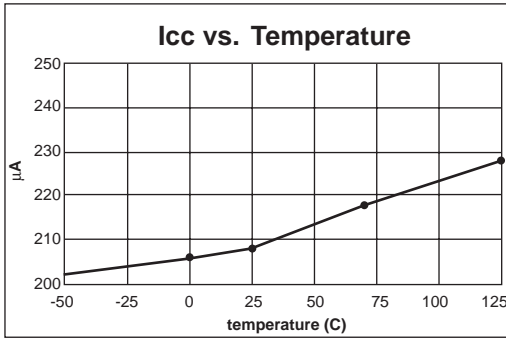
**FIGURE 2. DETAILED TIMING**

*SP8527 Timing Diagram*

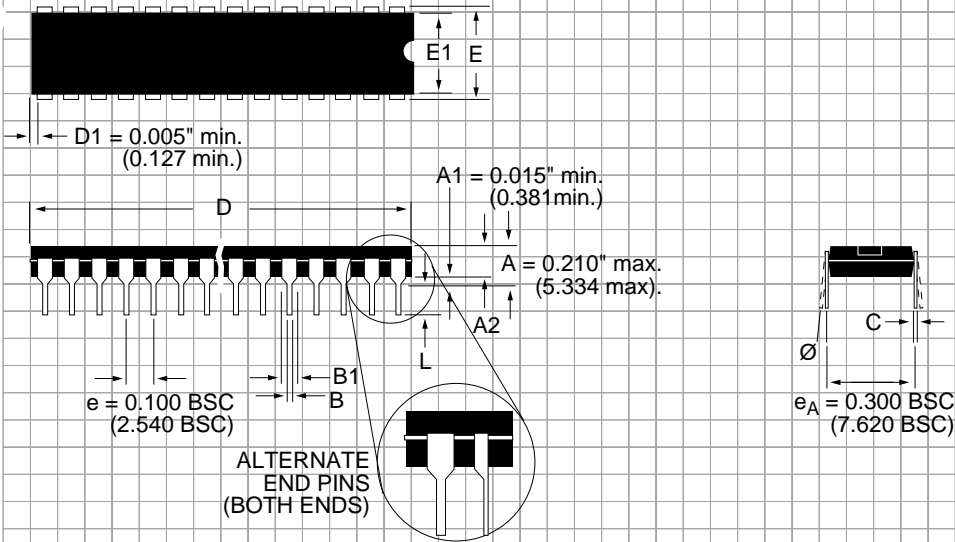




For all plots,  $V_{CC} = 5V$ , Conversion Rate = 38.3kHz.

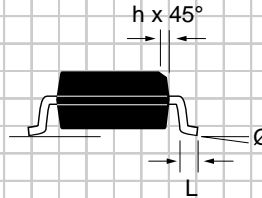
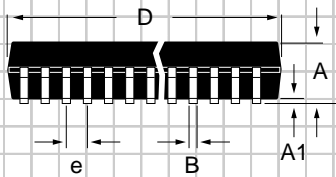
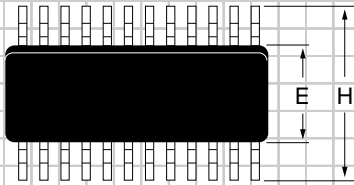


# PACKAGE: PLASTIC DUAL-IN-LINE (NARROW)



DIMENSIONS (Inches) Minimum/Maximum (mm)	8-PIN	14-PIN	16-PIN	18-PIN	20-PIN	22-PIN
A2	0.115/0.195 (2.921/4.953)	0.115/0.195 (2.921/4.953)	0.115/0.195 (2.921/4.953)	0.115/0.195 (2.921/4.953)	0.115/0.195 (2.921/4.953)	0.115/0.195 (2.921/4.953)
B	0.014/0.022 (0.356/0.559)	0.014/0.022 (0.356/0.559)	0.014/0.022 (0.356/0.559)	0.014/0.022 (0.356/0.559)	0.014/0.022 (0.356/0.559)	0.014/0.022 (0.356/0.559)
B1	0.045/0.070 (1.143/1.778)	0.045/0.070 (1.143/1.778)	0.045/0.070 (1.143/1.778)	0.045/0.070 (1.143/1.778)	0.045/0.070 (1.143/1.778)	0.045/0.070 (1.143/1.778)
C	0.008/0.014 (0.203/0.356)	0.008/0.014 (0.203/0.356)	0.008/0.014 (0.203/0.356)	0.008/0.014 (0.203/0.356)	0.008/0.014 (0.203/0.356)	0.008/0.014 (0.203/0.356)
D	0.355/0.400 (9.017/10.160)	0.735/0.775 (18.669/19.685)	0.780/0.800 (19.812/20.320)	0.880/0.920 (22.352/23.368)	0.980/1.060 (24.892/26.924)	1.145/1.155 (29.083/29.337)
E	0.300/0.325 (7.620/8.255)	0.300/0.325 (7.620/8.255)	0.300/0.325 (7.620/8.255)	0.300/0.325 (7.620/8.255)	0.300/0.325 (7.620/8.255)	0.300/0.325 (7.620/8.255)
E1	0.240/0.280 (6.096/7.112)	0.240/0.280 (6.096/7.112)	0.240/0.280 (6.096/7.112)	0.240/0.280 (6.096/7.112)	0.240/0.280 (6.096/7.112)	0.240/0.280 (6.096/7.112)
L	0.115/0.150 (2.921/3.810)	0.115/0.150 (2.921/3.810)	0.115/0.150 (2.921/3.810)	0.115/0.150 (2.921/3.810)	0.115/0.150 (2.921/3.810)	0.115/0.150 (2.921/3.810)
Ø	0°/15° (0°/15°)	0°/15° (0°/15°)	0°/15° (0°/15°)	0°/15° (0°/15°)	0°/15° (0°/15°)	0°/15° (0°/15°)

**PACKAGE: PLASTIC  
SMALL OUTLINE (SOIC)  
(NARROW)**



DIMENSIONS (Inches) Minimum/Maximum (mm)	8-PIN	14-PIN	16-PIN
A	0.053/0.069 (1.346/1.748)	0.053/0.069 (1.346/1.748)	0.053/0.069 (1.346/1.748)
A1	0.004/0.010 (0.102/0.249)	0.004/0.010 (0.102/0.249)	0.004/0.010 (0.102/0.249)
B	0.014/0.019 (0.35/0.49)	0.013/0.020 (0.330/0.508)	0.013/0.020 (0.330/0.508)
D	0.189/0.197 (4.80/5.00)	0.337/0.344 (8.552/8.748)	0.386/0.394 (9.802/10.000)
E	0.150/0.157 (3.802/3.988)	0.150/0.157 (3.802/3.988)	0.150/0.157 (3.802/3.988)
e	0.050 BSC (1.270 BSC)	0.050 BSC (1.270 BSC)	0.050 BSC (1.270 BSC)
H	0.228/0.244 (5.801/6.198)	0.228/0.244 (5.801/6.198)	0.228/0.244 (5.801/6.198)
h	0.010/0.020 (0.254/0.498)	0.010/0.020 (0.254/0.498)	0.010/0.020 (0.254/0.498)
L	0.016/0.050 (0.406/1.270)	0.016/0.050 (0.406/1.270)	0.016/0.050 (0.406/1.270)
Ø	0°/8° (0°/8°)	0°/8° (0°/8°)	0°/8° (0°/8°)

## ORDERING INFORMATION

Model .....	Linearity (LSB) .....	Temperature Range .....	Package .....
SP8527BN .....	±1.0 .....	-40°C to +85°C .....	8-pin, 0.3" Plastic DIP
SP8527KN .....	±1.0 .....	-0°C to +70°C .....	8-pin, 0.3" Plastic DIP
SP8527BS .....	±1.0 .....	-40°C to +85°C .....	8-pin, 0.15" Plastic SOIC
SP8527KS .....	±1.0 .....	-0°C to +70°C .....	8-pin, 0.15" Plastic SOIC

Please consult the factory for pricing and availability on a Tape-On-Reel option.



SIGNAL PROCESSING EXCELLENCE

### Sipex Corporation

#### Headquarters and Sales Office

22 Linnell Circle  
Billerica, MA 01821  
TEL: (978) 667-8700  
FAX: (978) 670-9001  
e-mail: sales@sipex.com

#### Sales Office

233 South Hillview Drive  
Milpitas, CA 95035  
TEL: (408) 934-7500  
FAX: (408) 935-7600

Sipex Corporation reserves the right to make changes to any products described herein. Sipex does not assume any liability arising out of the application or use of any product or circuit described hereing; neither does it convey any license under its patent rights nor the rights of others.