

Product Description

Stanford Microdevices' SPA-1218 is a high efficiency GaAs Heterojunction Bipolar Transistor (HBT) amplifier housed in a low-cost surface-mountable plastic package. These HBT amplifiers are fabricated using molecular beam epitaxial growth technology which produces reliable and consistent performance from wafer to wafer and lot to lot.

This product is specifically designed for use as a driver amplifier for infrastructure equipment in the 1950 MHz PCS band. Its high linearity makes it an ideal choice for multi-carrier and digital applications.

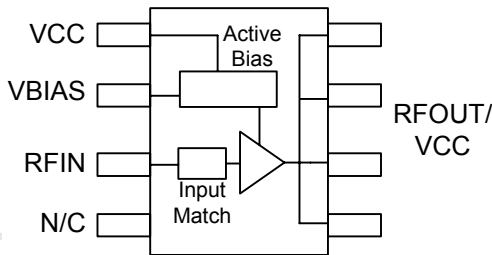

SPA-1218

1960 MHz 1 Watt Power Amp with Active Bias

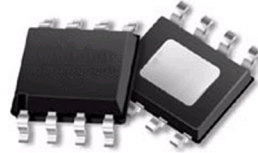

Product Features

- On-chip Active Bias Control
- Patented High Reliability GaAsHBT Technology
- High Linearity Performance: +48dBm OIP3 Typ.
- Surface-Mountable Plastic Package

Applications

- PCS Systems
- Multi-Carrier Applications

Symbol	Parameters: Test Conditions: $Z_0 = 50 \text{ Ohms}$, $V_{CC}=5V$, $Temp = 27^\circ C$	Units	Min.	Typ.	Max.
f_0	Frequency of Operation	MHz	1930		1990
P_{1dB}	Output Power at 1dB Compression V_{c_1} , V_{bias} , $V_{c_2} = 5.0V$	dBm		29.5	
S_{21}	Small Signal Gain	dB		12.0	
S_{11}	Input VSWR	-		1.5:1	
OIP_3	Output Third Order Intercept Point Power out per tone = +14 dBm	dBm		48.0	
I_{cc}	Device Current, $V_{CC} = 5V$	mA		320	
$R_{th, j-l}$	Thermal Resistance (junction - lead)	$^\circ C/W$		40	

The information provided herein is believed to be reliable at press time. Stanford Microdevices assumes no responsibility for inaccuracies or omissions. Stanford Microdevices assumes no responsibility for the use of this information, and all such information shall be entirely at the user's own risk. Prices and specifications are subject to change without notice. No patent rights or licenses to any of the circuits described herein are implied or granted to any third party. Stanford Microdevices does not authorize or warrant any Stanford Microdevices product for use in life-support devices and/or systems. Copyright 2000 Stanford Microdevices, Inc. All worldwide rights reserved.

1950 MHz Application Circuit Data, $I_{cc}=320\text{ mA}$, $T=+27\text{C}$, $V_{CC}=5\text{V}$

Note: Tuned for Output IP3

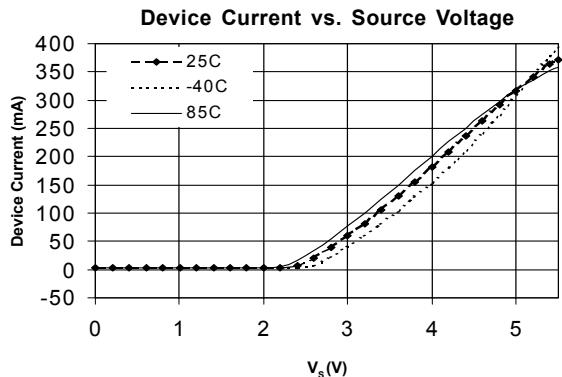
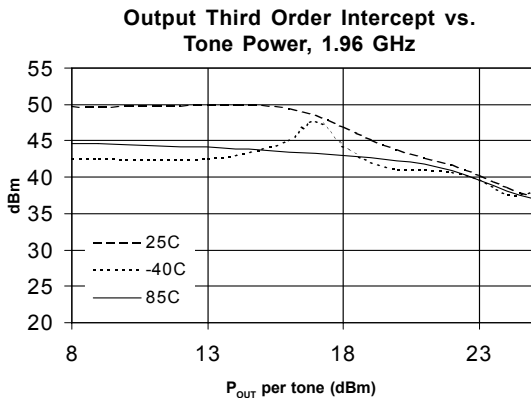
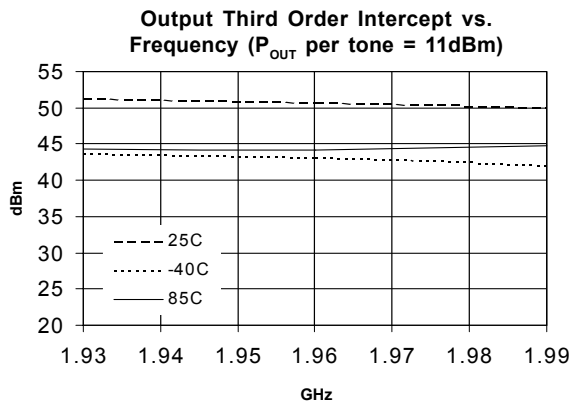
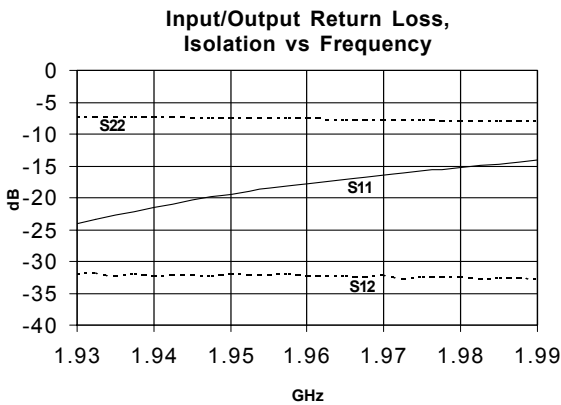
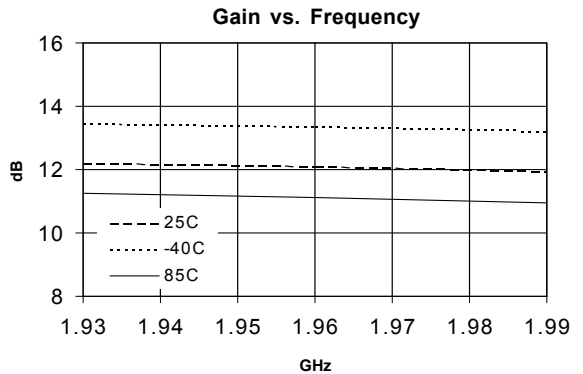
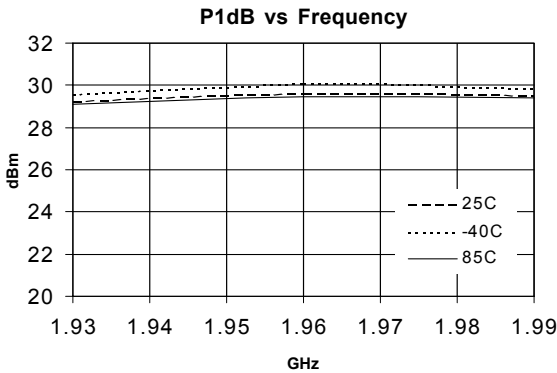

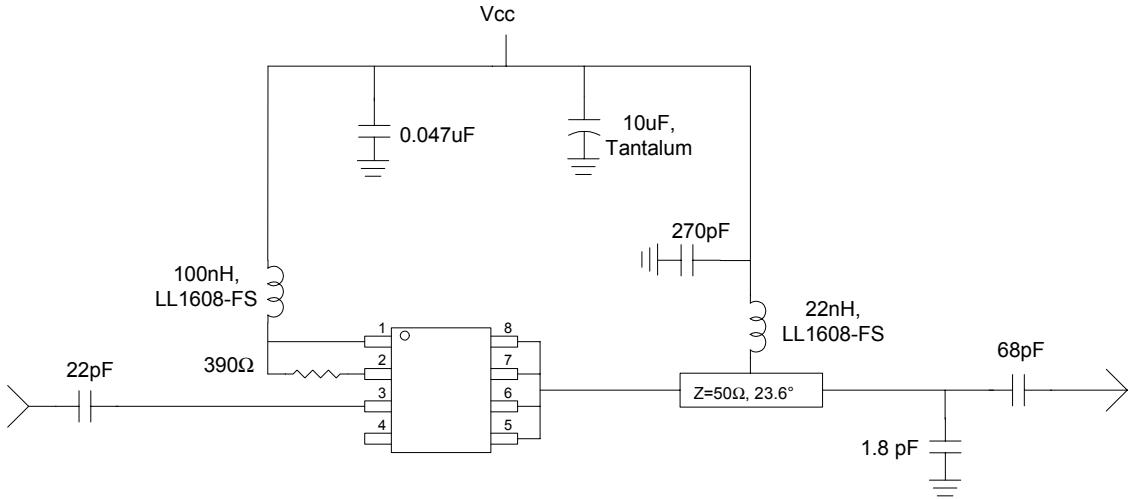

1930-1990 MHz Schematic

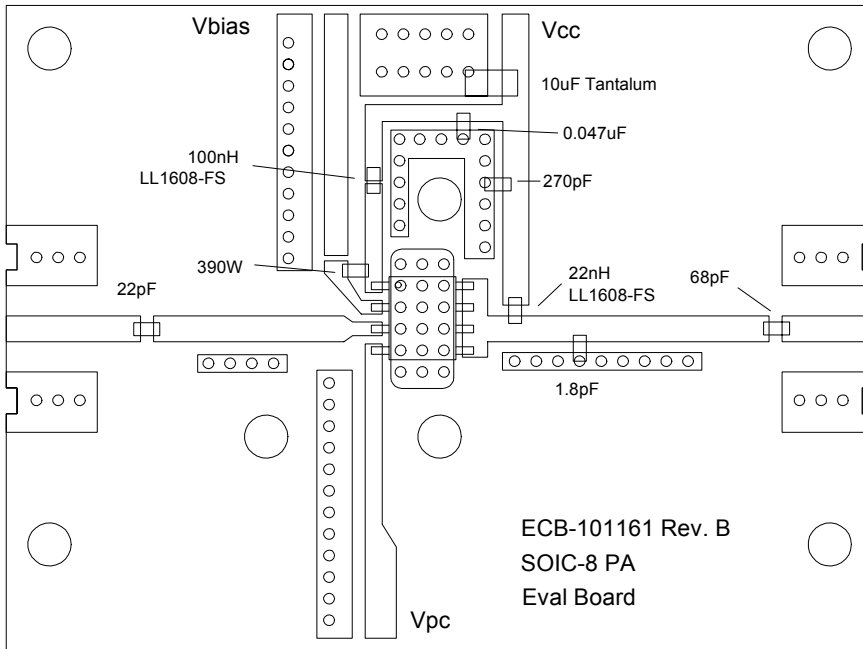

1930-1990 MHz Evaluation Board Layout

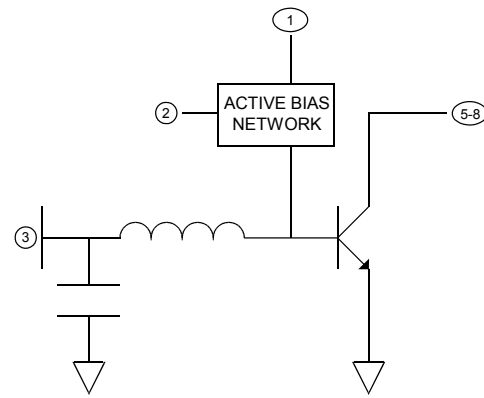
Pin #	Function	Description	Device Schematic
1	VCC	VCC is the supply voltage for the active bias network. Bypassing in the appropriate location as shown on application schematic is required for optimum RF performance.	
2	Vbias	Vbias is the bias control pin for the active bias network. Device current is set by the current into this pin. Recommended configuration is shown in the Application Schematic. Bypassing in the appropriate location as shown on application schematic is required for optimum RF performance.	
3	RF In	RF input pin. This pin requires the use of an external DC blocking capacitor chosen for the frequency of operation.	
4	N/C	No connection	
5	RF Out/Vcc	RF output and bias pin. Bias should be supplied to this pin through an external RF choke. Because DC biasing is present on this pin, a DC blocking capacitor should be used in most applications (see application schematic). The supply side of the bias network should be well bypassed. An output matching network is necessary for optimum performance.	
6	RF Out/Vcc	Same as Pin 5	
7	RF Out/Vcc	Same as Pin 5	
8	RF Out/Vcc	Same as Pin 5	

Absolute Maximum Ratings

Operation of this device above any one of these parameters may cause permanent damage.

Bias Conditions should also satisfy the following expression: $I_D V_D (\text{max}) < (T_J - T_{OP}) / R_{thj-l}$

Parameter	Value	Unit
Supply Current (I_D)	750	mA
Device Voltage (V_D)	6.0	V
Power Dissipation	4.0	W
Operating Temperature (T_{op})	-40 to +85	°C
RF Input Power	+500	mW
Storage Temperature Range	-40 to +150	°C
Operating Junction Temperature (T_J)	+150	°C

SPA-1218 1950 MHz 1 Watt Power Amp.



Caution: ESD sensitive

Appropriate precautions in handling, packaging and testing devices must be observed.

Part Number Ordering Information

Part Number	Devices Per Reel	Reel Size
SPA-1218	500	7"

Package Outline Drawing

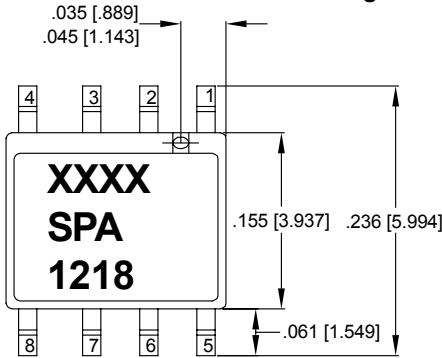

TOP VIEW

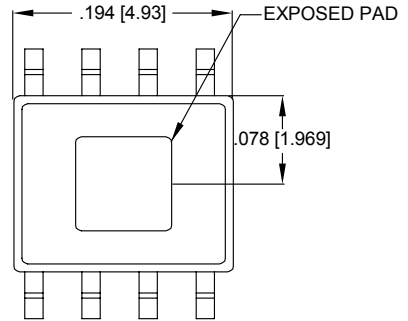

BOTTOM VIEW

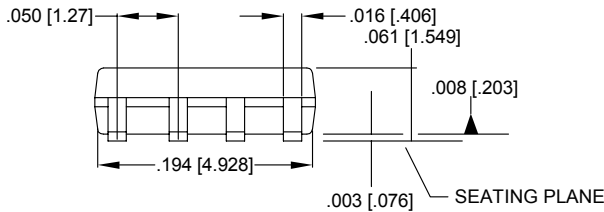

SIDE VIEW

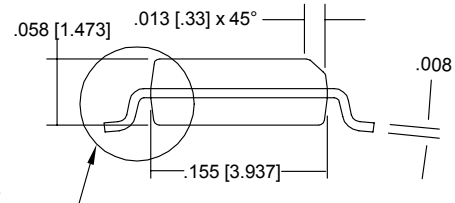

SEE DETAIL A

END VIEW

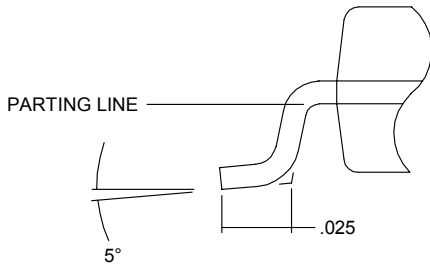

DETAIL A

Recommended Land Pattern

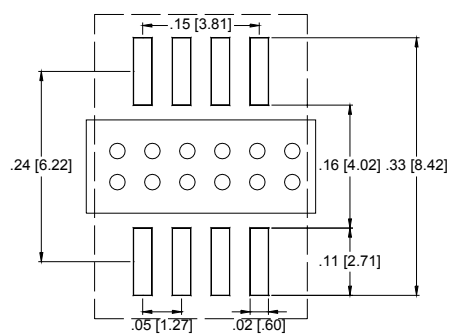

Note: XXXX represents the lot code



Note: Parts need to be baked prior to use as discussed in application note AN-029 (Special handling information for Exposed Pad™ SOIC-8 products) to ensure no moisture is trapped in the encapsulated package. In production, this baking procedure is not necessary if parts are used within 24 hours of opening the sealed shipping materials.