

Product Description

RFMD's SPA1526Z is a high linearity single-stage class A Heterojunction Bipolar Transistor (HBT) power amplifier. The SPA1526Z is made with InGaP-on-GaAs device technology and fabricated with MOCVD for an ideal combination of low cost and high reliability. It is well suited for use as a driver stage in macro/micro-cell infrastructure equipment, or as the final output stage in pico-cell infrastructure equipment. It features an input power detector, on/off power control, ESD protection, excellent overall robustness, and a hand reworkable and thermally enhanced SOF-26 package.

Optimum Technology Matching® Applied

- GaAs HBT
- GaAs MESFET
- InGaP HBT
- SiGe BiCMOS
- Si BiCMOS
- SiGe HBT
- GaAs pHEMT
- Si CMOS
- Si BJT
- GaN HEMT
- InP HBT
- RF MEMS
- LDMOS

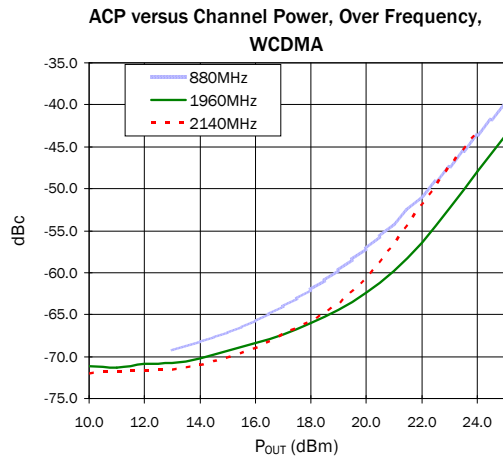

Features

- P_{1dB} = 32 dBm @ 2140 MHz
- ACP = -65 dBc with 18.4 dBm Channel Power @ 2140 MHz
- Low Thermal Resistance Package
- Power Up/Down Control < 1 μs
- Robust Class 1C ESD

Applications

- Macro/Micro-Cell Driver Stage
- Pico-Cell Output Stage
- GSM, CDMA, TDSCDMA, WCDMA, IS-95
- Single and Multi-Carrier Applications

Parameter	Specification			Unit	Condition
	Min.	Typ.	Max.		
Small Signal Power Gain		15.4		dB	885 MHz
		14.0		dB	1960 MHz
	12.3	13.7	15.1	dB	2140 MHz
Output Power at 1dB Compression		32.5		dBm	885 MHz
		32.5		dBm	1960 MHz
	30.8	32.0		dBm	2140 MHz
Output Third Order Intercept Point, 18dBm per Tone, 1MHz Spacing		45.5		dBm	885 MHz
		49		dBm	1960 MHz
	44	49		dBm	2140 MHz
WCDMA Channel Power					3GPP 3.5, test model 1, 64 DPCH
-65dBc ACP		16.5		dBm	885 MHz
-55dBc ACP		20.7		dBm	885 MHz
-65dBc ACP		18.6		dBm	1960 MHz
-55dBc ACP		22.3		dBm	1960 MHz
-65dBc ACP		18.4		dBm	2140 MHz
-55dBm ACP		21.3		dBm	2140 MHz
21.8dBm ACP		-55	-50	dBc	2140 MHz
Input Return Loss		20		dB	1960 MHz
Output Return Loss		13.5		dB	1960 MHz
Noise Figure		5.5		dB	1960 MHz
Operating Current (V _{CC} =5V), Quiescent	580	645	710	mA	
Operating Voltage		5.0	5.5	V	

RF MICRO DEVICES®, RFMD®, Optimum Technology Matching®, Enabling Wireless Connectivity™, PowerStar®, POLARIS™ TOTAL RADIO™ and UltimateBlue™ are trademarks of RFMD, LLC. BLUETOOTH is a trademark owned by Bluetooth SIG, Inc., U.S.A. and licensed for use by RFMD. All other trade names, trademarks and registered trademarks are the property of their respective owners. ©2006, RF Micro Devices, Inc.

Absolute Maximum Ratings

Parameter	Rating	Unit
Max Device Current (I_{CE})	1500	mA
*Max Device Voltage (V_{CC})	6.0	V
Power Dissipation	6	W
Max CW Input Power		
50Ω output load	33	dBm
10:1 VSWR output load	21	dBm
**Max Modulated (W-CDMA) Input Power		
50Ω output load	26	dBm
10:1 VSWR output load	18	dBm
Max RF Output Power with 50Ω output load (Continuous long term operation)	30	dBm
Max Junction Temperature (T_J)	150	°C
Operating Temperature Range (T_L)	-40 to + 85	°C
Max Storage Temperature	150	°C
ESD Rating - Human Body Model (HBM)	Class 1C	
Moisture Sensitivity Level	MSL 1	



Caution! ESD sensitive device.

Exceeding any one or a combination of the Absolute Maximum Rating conditions may cause permanent damage to the device. Extended application of Absolute Maximum Rating conditions to the device may reduce device reliability. Specified typical performance or functional operation of the device under Absolute Maximum Rating conditions is not implied.

The information in this publication is believed to be accurate and reliable. However, no responsibility is assumed by RF Micro Devices, Inc. ("RFMD") for its use, nor for any infringement of patents, or other rights of third parties, resulting from its use. No license is granted by implication or otherwise under any patent or patent rights of RFMD. RFMD reserves the right to change component circuitry, recommended application circuitry and specifications at any time without prior notice.



RFMD Green: RoHS compliant per EU Directive 2002/95/EC, halogen free per IEC 61249-2-21, < 1000ppm each of antimony trioxide in polymeric materials and red phosphorus as a flame retardant, and <2% antimony in solder.

*No RF Drive

**W-CDMA, 64 DPCH, 1 CH Forward

Operation of this device beyond any one of these limits may cause permanent damage. For reliable continuous operation, the device voltage and current must not exceed the maximum operating values specified in the table on page one.

Bias Conditions should also satisfy the following expression:

$$I_D V_D < (T_J - T_L) / R_{TH}, J-I \text{ and } T_L = T_{LEAD}$$

Parameter	Specification			Unit	Condition
	Min.	Typ.	Max.		
Power Up Control Current ($V_{PC}=5V$)		2.1		mA	
V_{CC} Leakage Current ($V_{CC}=5V$, $V_{PC}=0V$)			100	μA	
Thermal Resistance		12		°C/W	junction to lead

Test Conditions: $V_{CC}=5V$, $I_{CQ}=318mA$ Typ., $T_L=25^\circ C$, $Z_0=Z_L=50\Omega$

Simplified Device Schematic

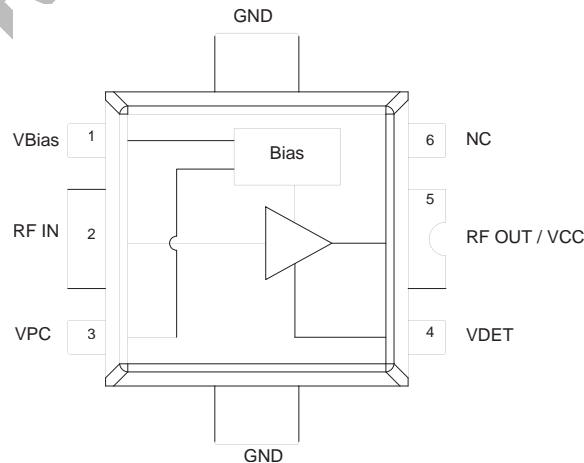

Typical RF Performance 850MHz to 910MHz Application Circuit

ACP versus Channel Power, 880MHz, WCDMA

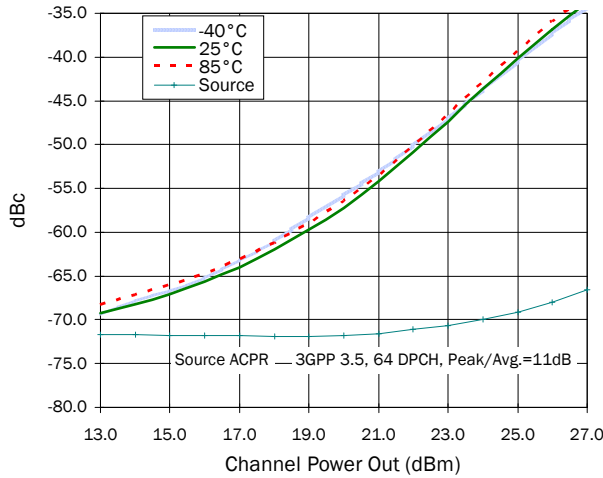

ACP versus Channel Power, 880MHz, IS-95

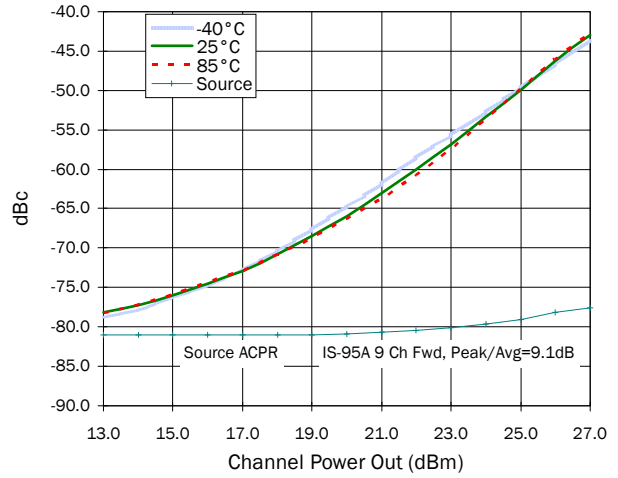

ACP versus Channel Power, W-CDMA, 25 °C

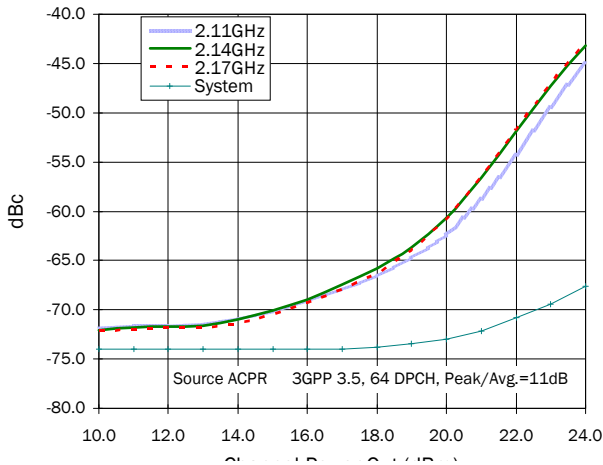

ACP versus Channel Power, IS-95, 25 °C

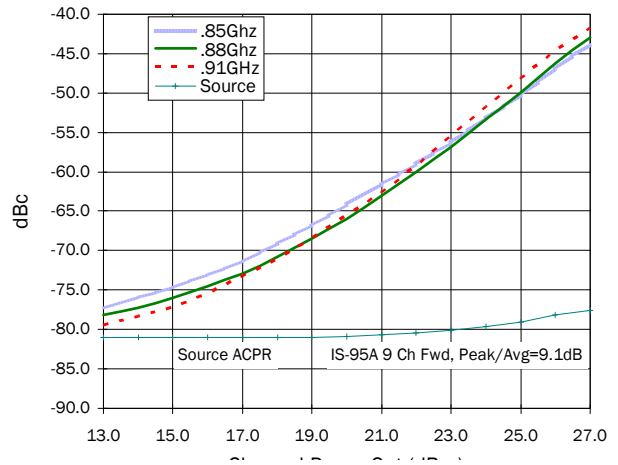

P1dB versus Frequency

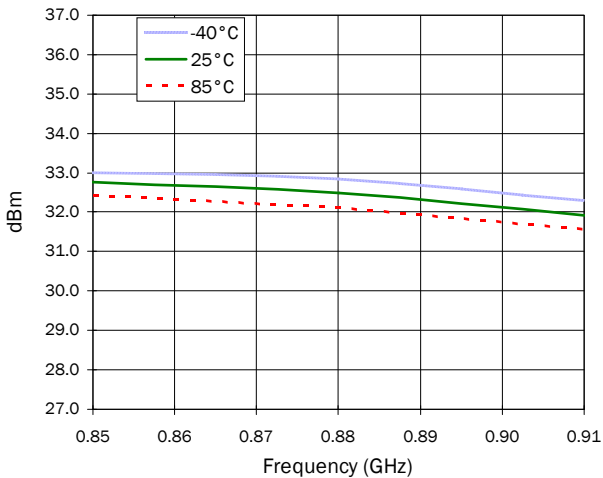

OIP3 versus Frequency, 22dBm/Tone

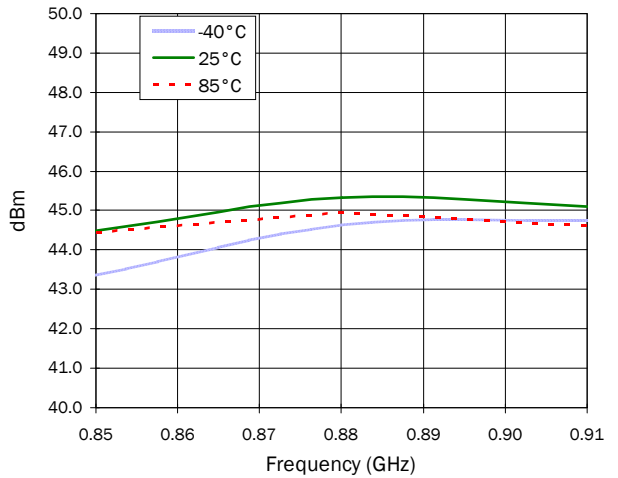

Typical RF Performance 850MHz to 910MHz Application Circuit

S11 versus Frequency

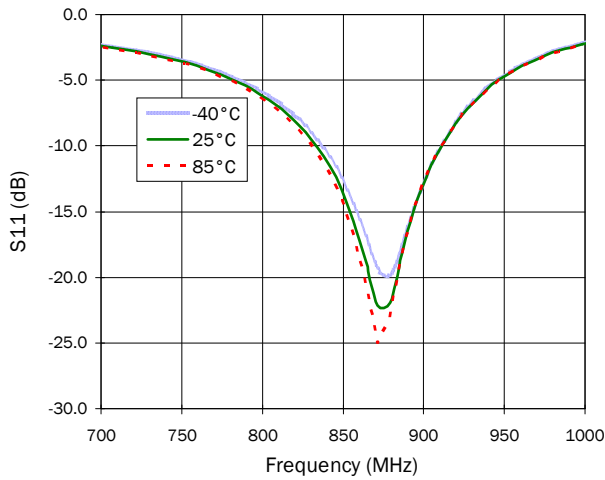

S21 versus Frequency

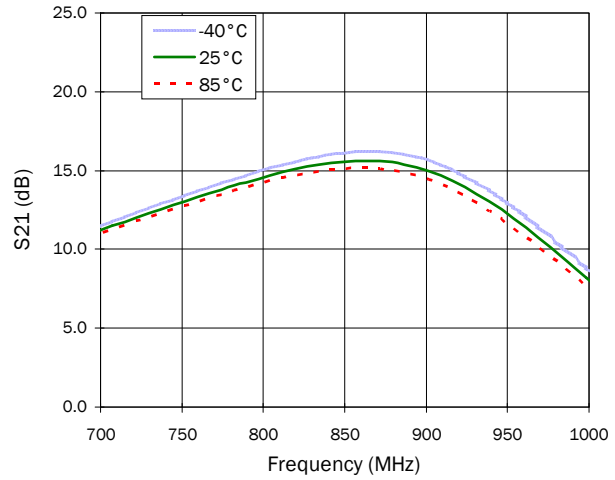

S12 versus Frequency

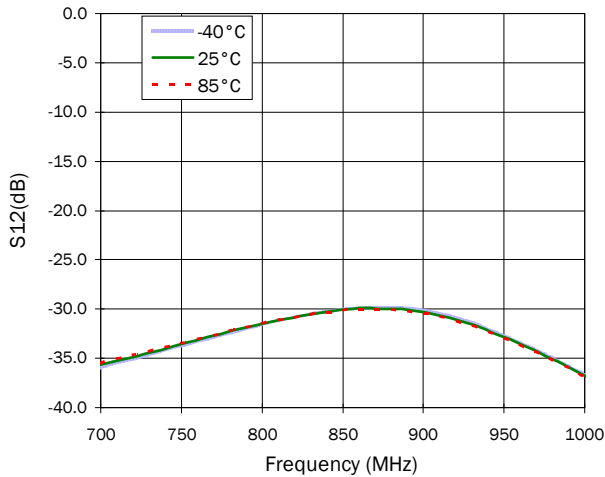

S22 versus Frequency

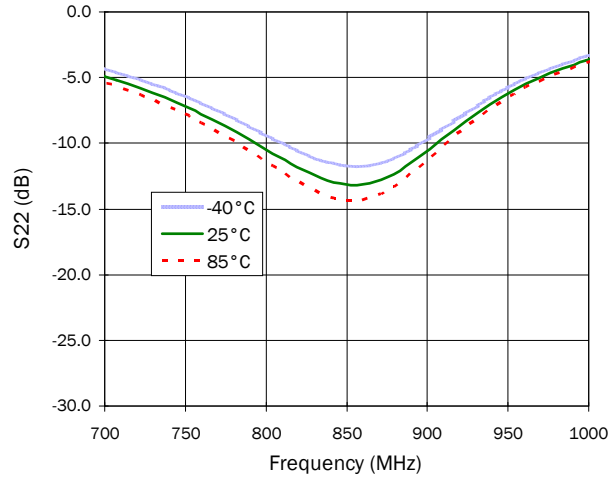

Noise Figure, 5V, 25 °C

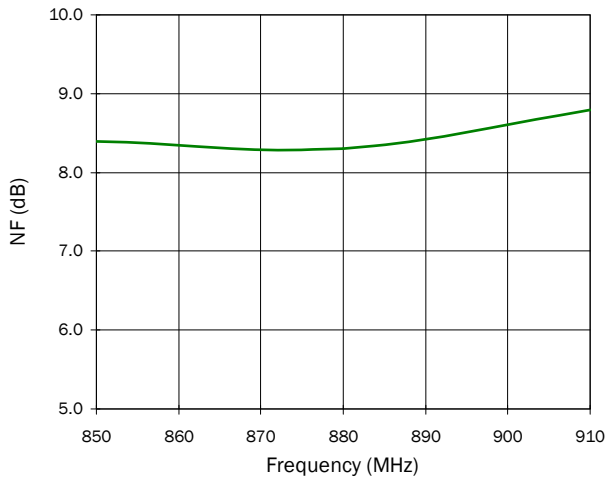

VDETECT versus Output Power @880MHz

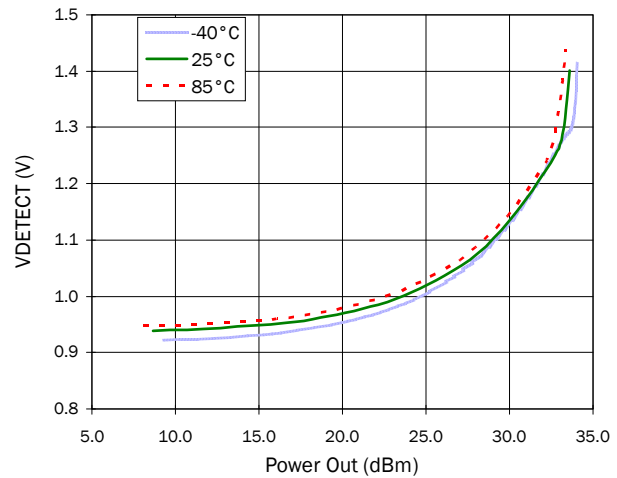

Typical RF Performance 1930MHz to 1960MHz Application Circuit

ACP versus Channel Power, 1960MHz, W-CDMA

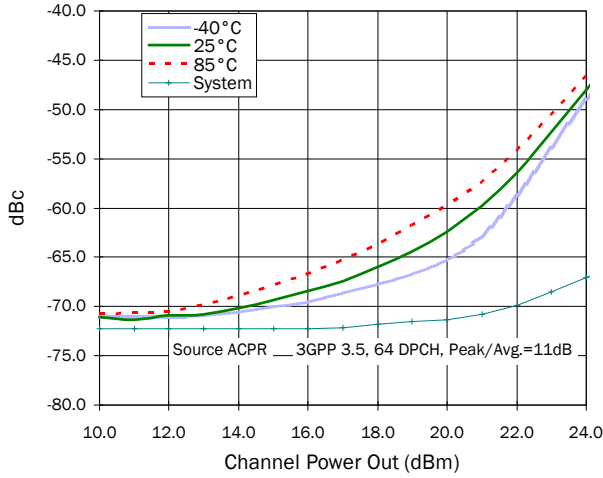

ACP versus Channel Power, 1960MHz, IS-95

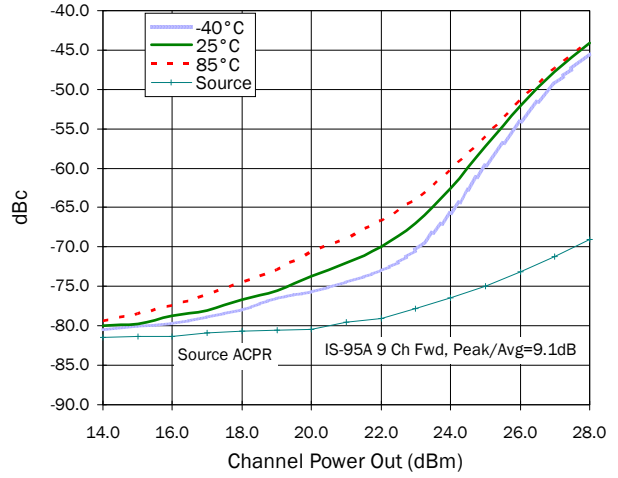

ACP versus Channel Power, W-CDMA, 25°C

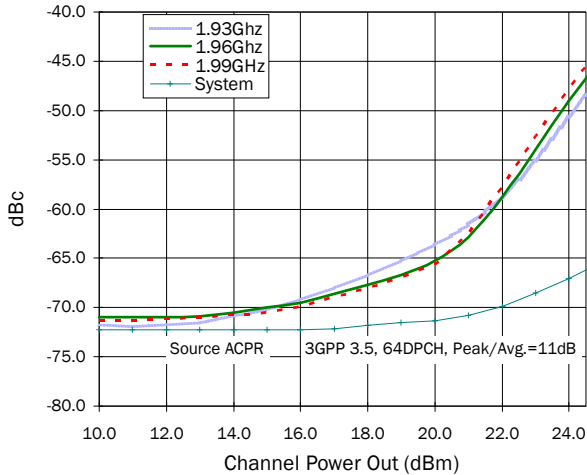

ACP versus Channel Power, IS-95, 25°C

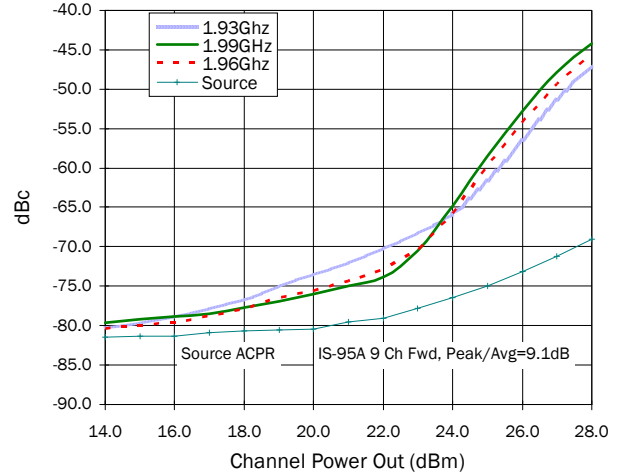

P1dB versus Frequency

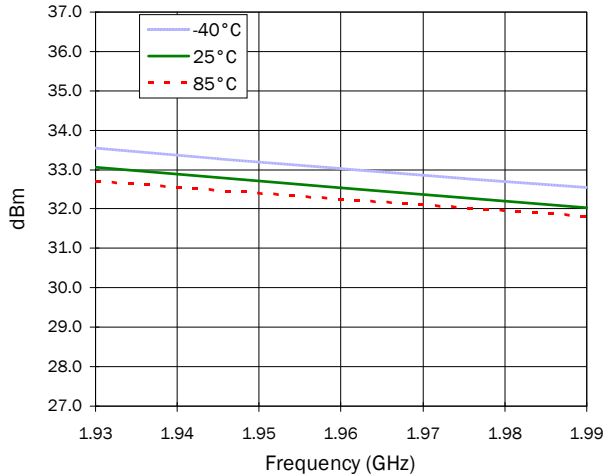

OIP3 versus Frequency, 22dBm/tone

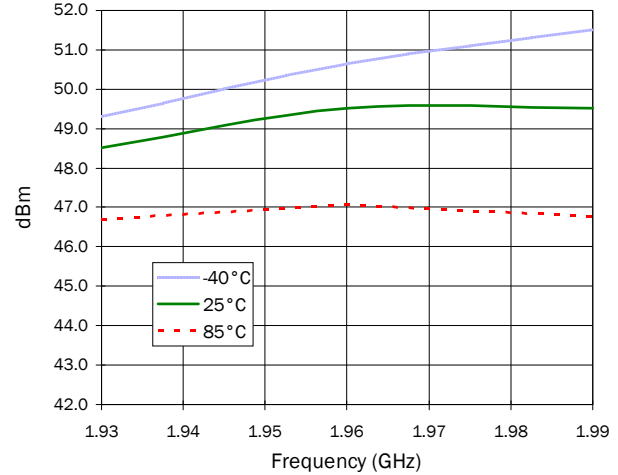

Typical RF Performance 1930MHz to 1990MHz Application Circuit

S11 versus Frequency

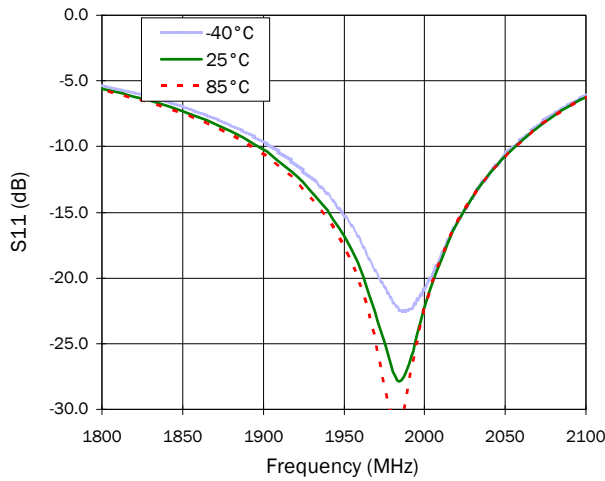

S21 versus Frequency

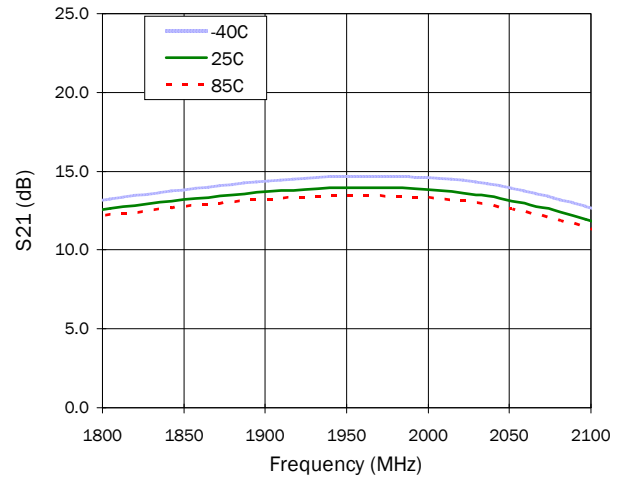

S12 versus Frequency

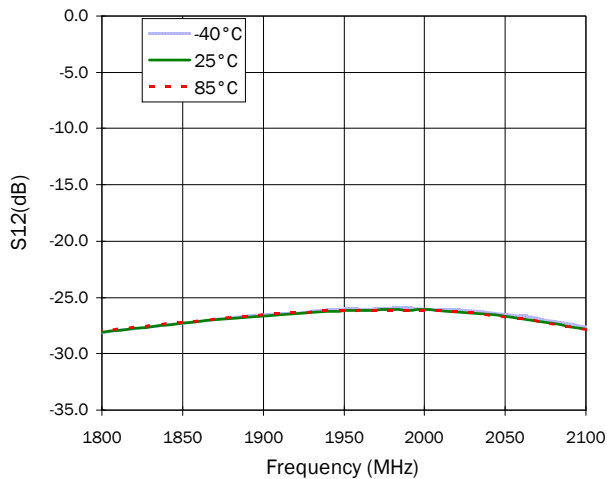

S22 versus Frequency

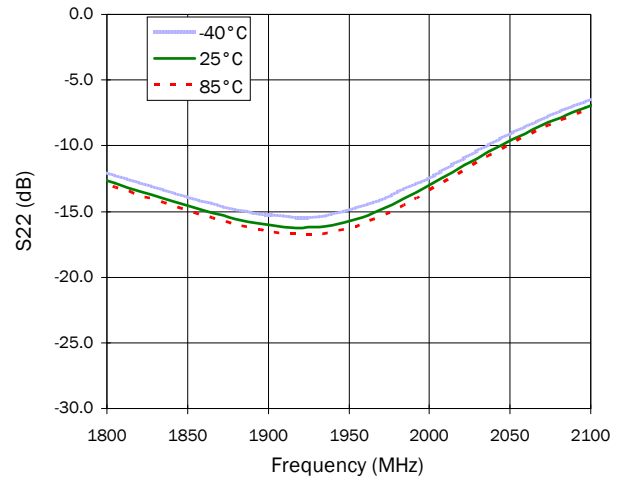

Noise Figure, 5V 25 °C

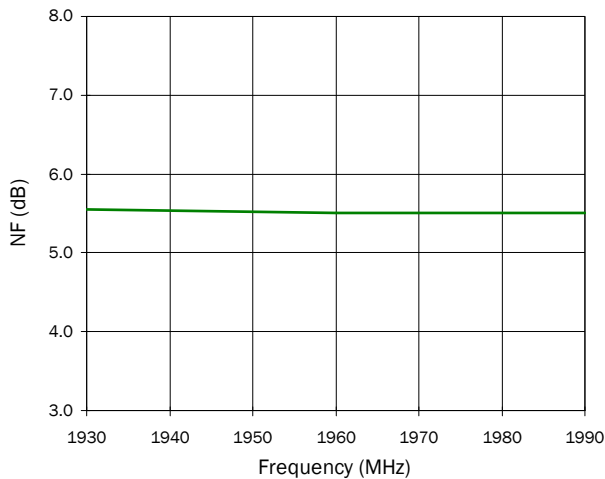

VDETECT versus Output Power @1960MHz

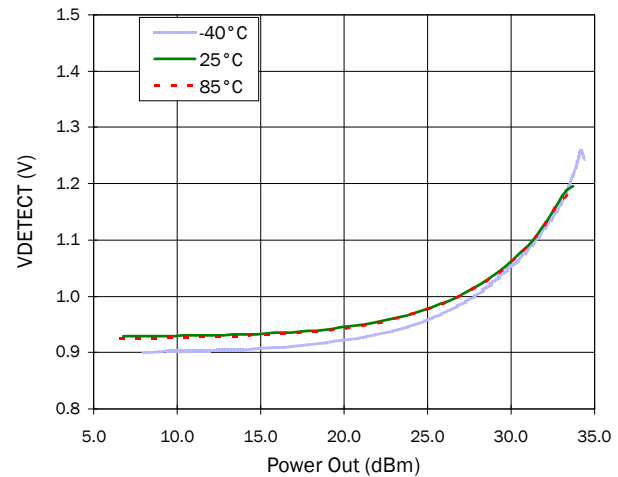

Typical RF Performance 2110MHz to 2170MHz Application Circuit

ACP versus Channel Power, 2140MHz, W-CDMA

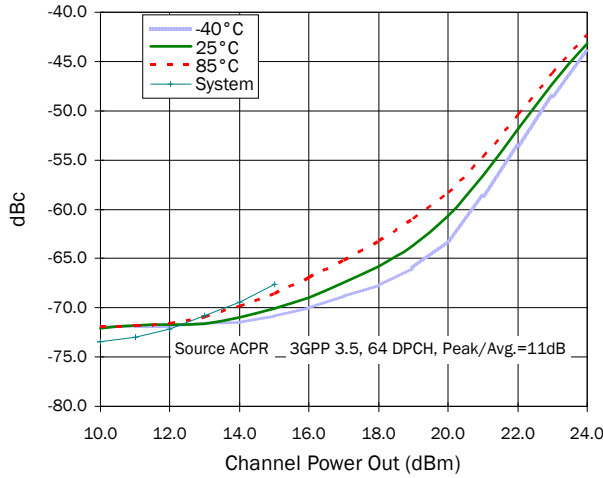

ACP versus Channel Power, W-CDMA, 25°C

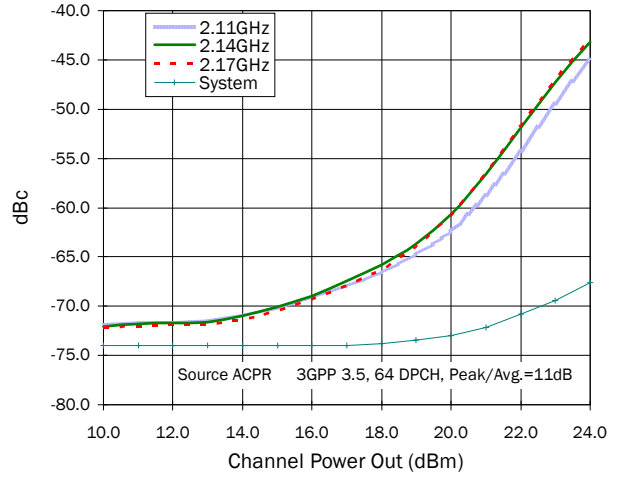

P1dB versus Frequency

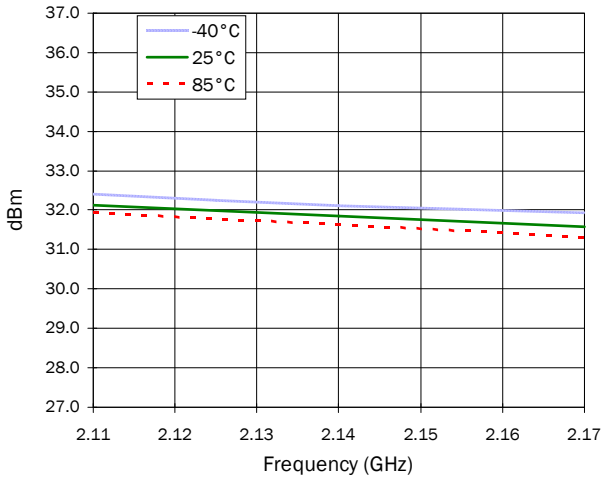

OIP3 versus Frequency, 22dBm/Tone

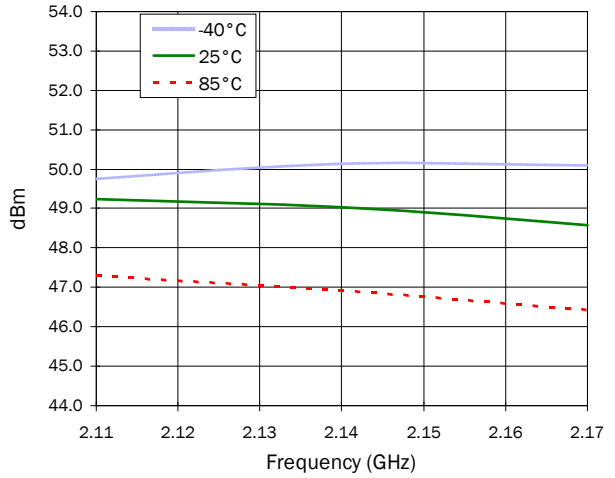

Noise Figure, 5V, 25°C

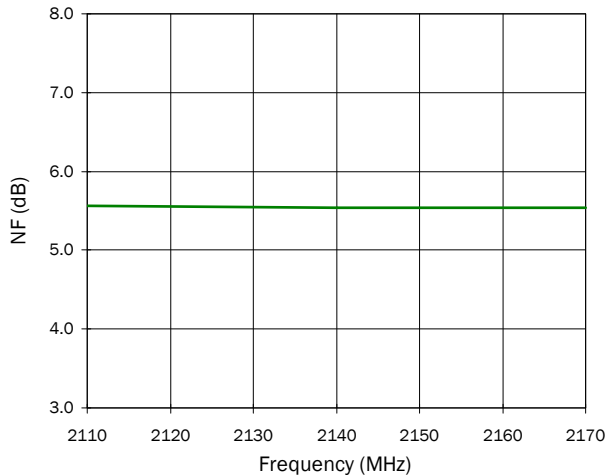

VDETECT versus Output Power @ 2140MHz

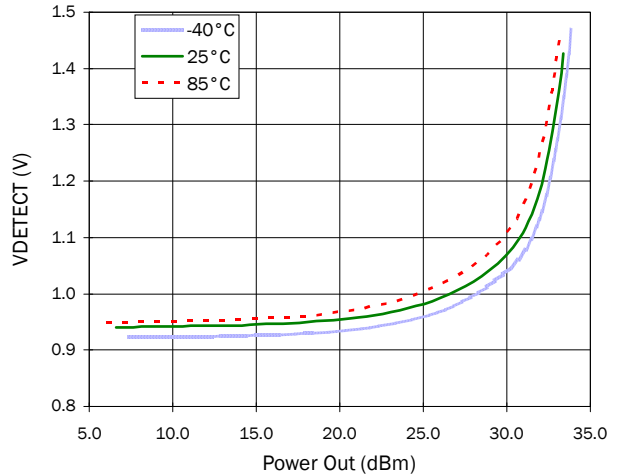

Typical RF Performance 2110MHz to 2170MHz Application Circuit

S11 versus Frequency

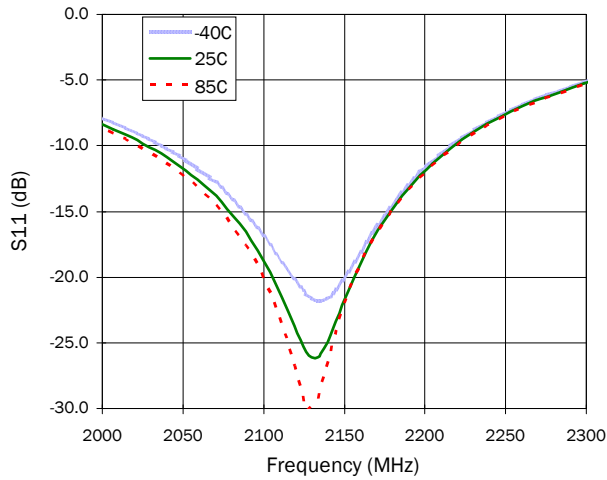

S21 versus Frequency

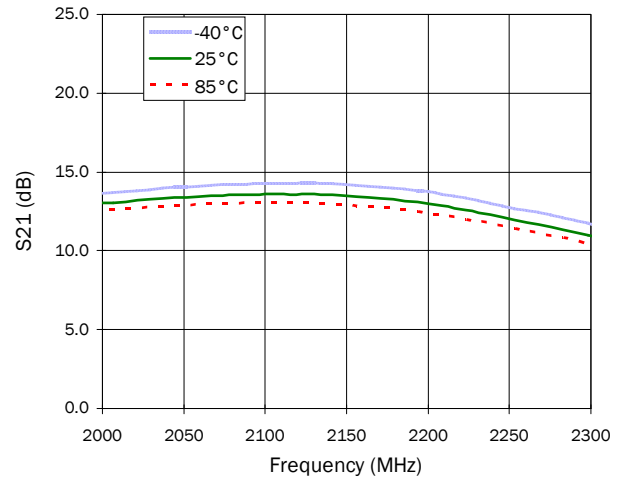

S12 versus Frequency

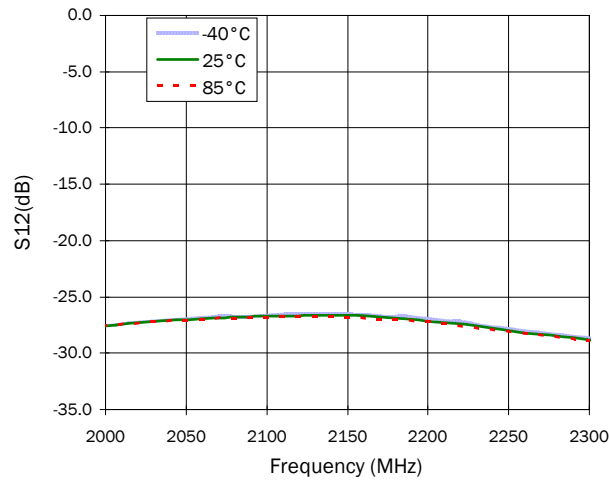

S22 versus Frequency

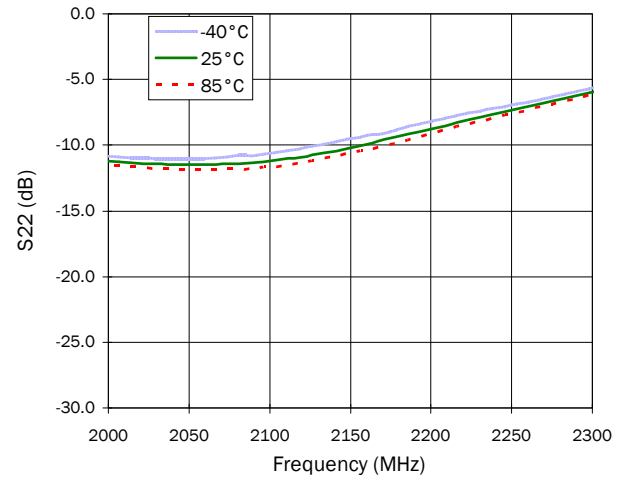

NOT FOR

Evaluation Board Schematic
(850MHz to 910MHz Application Circuit)

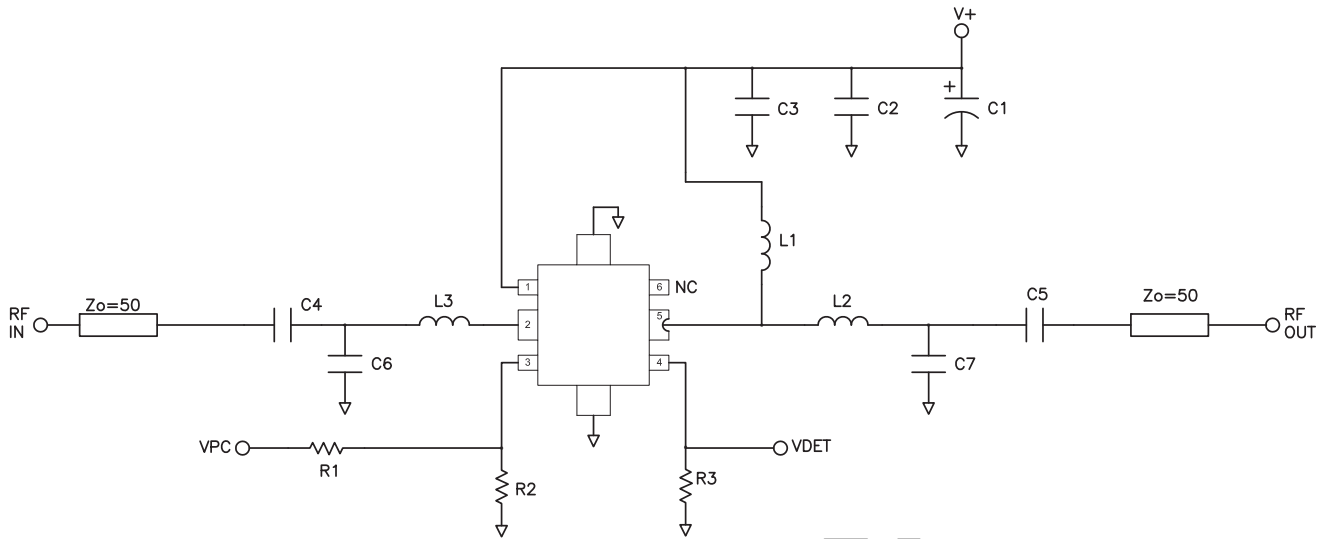

NOT FOR NEW DESIGN

Evaluation Board Layout and Bill of Materials

850MHz to 910MHz Application Circuit (V_{CC} and $V_{PC}=5.0V$)

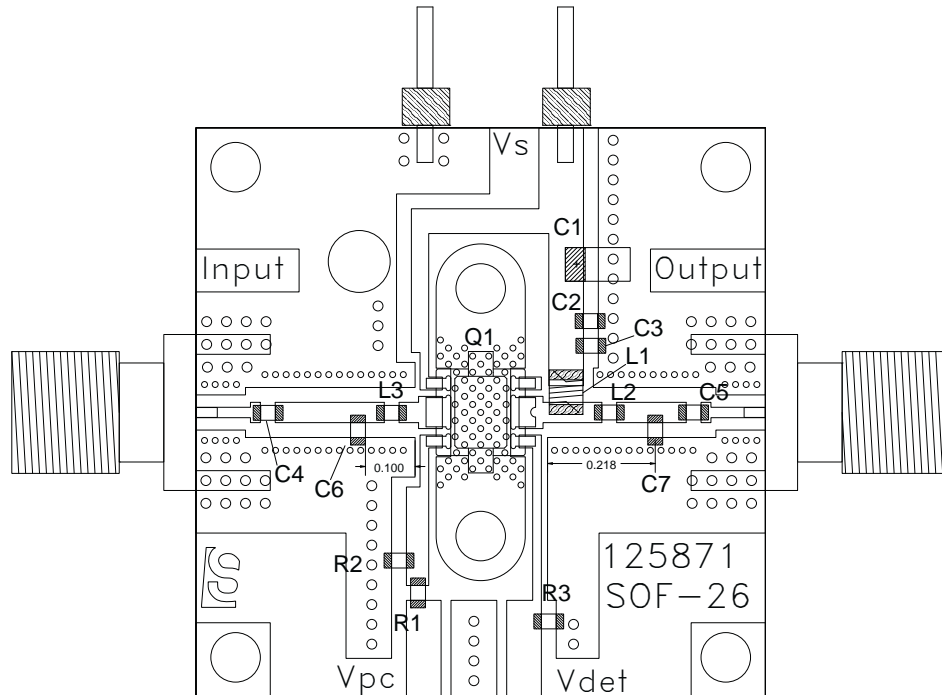

Bill of Materials

Q1	SPA1526Z	
R1	825ohm 1%	
R2	4.32K ohm 1%	
R3	47k ohm	
C1	TAJA105K020R	1.0uF
C2	MCH185CN104KK	0.1uF
C3	MCH185A101JK	100pF
C4	MCH185A101JK	100pF
C5	MCH185A101JK	100pF
C6	MCH185A100JK	10pF
C7	MCH185A8R2JK	8.2pF
L1	0805HQ-48NX_BC	48nH Coil Craft
L2	LL1608FS-1N5S	1.5nH Toko
L3	LL1608FS-2N2S	2.7nH Toko
PCB	125871	

NOT F

Evaluation Board Schematic
(1930MHz to 1990MHz Application Circuit)

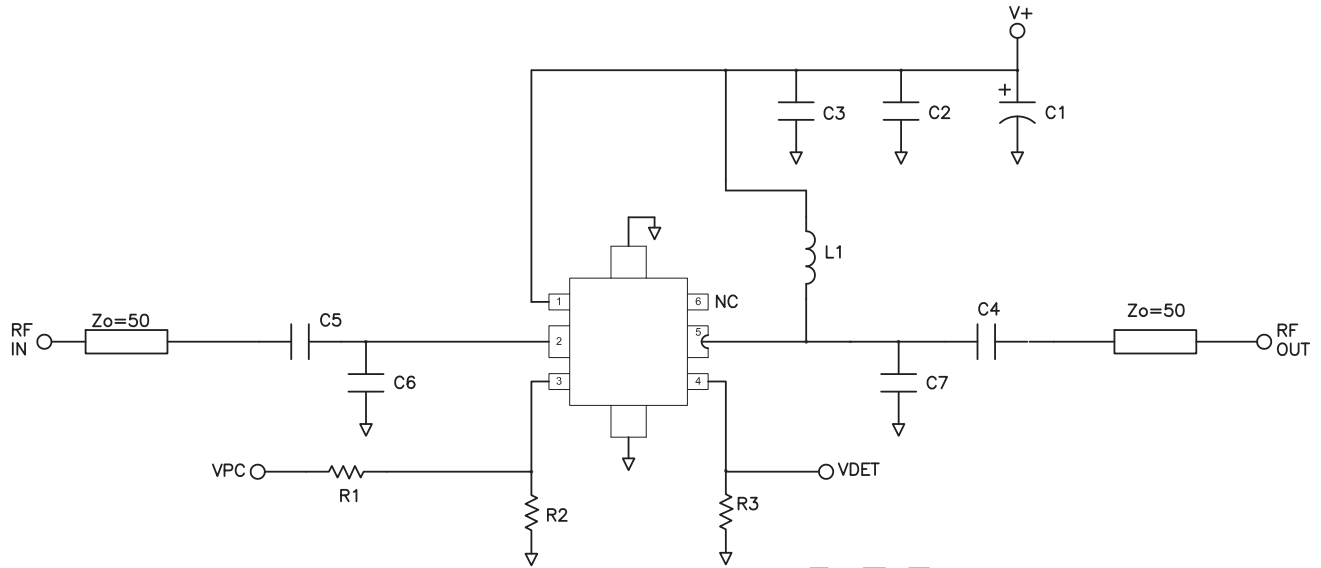

NOT FOR NEW DESIGN

Evaluation Board Layout and Bill of Materials

1930MHz to 1990MHz Application Circuit (V_{CC} and $V_{PC}=5.0V$)

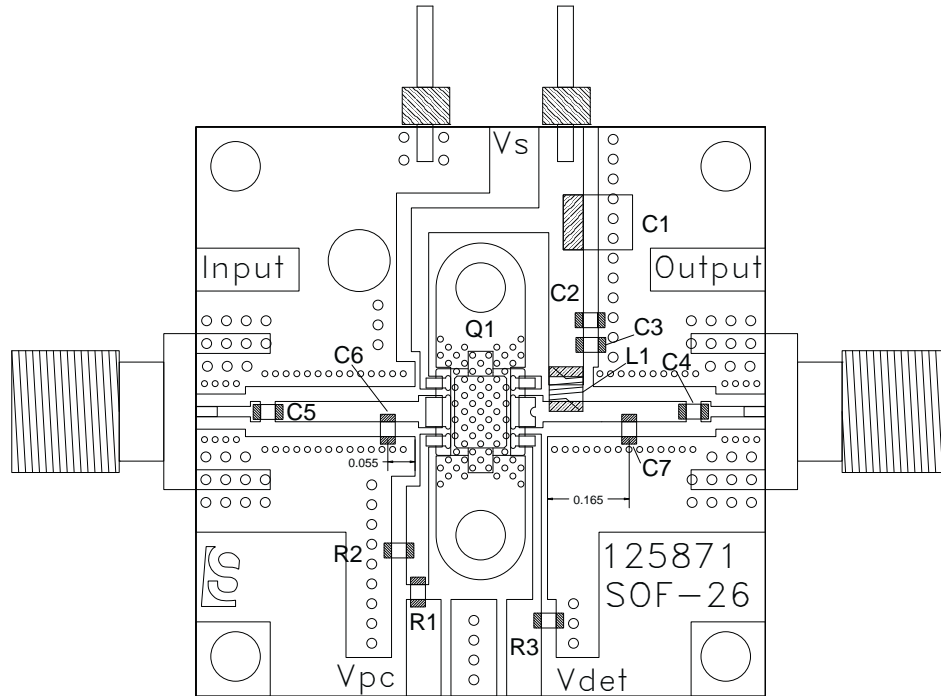

Bill of Materials

Q1	SPA1526Z	
R1	825ohm 1%	
R2	4.32K ohm 1%	
R3	47k ohm	
C1	TAJA106K020R	10.0uF
C2	MCH185CN104KK	0.1uF
C3	06035J100GBT	10pF AVX
C4	06035J100GBT	10pF AVX
C5	06035J100GBT	10pF AVX
C6	06035J3R9BBT	3.9pF AVX
C7	06035J3R0BBT	3.0pF AVX
L1	0805HQ-20NX_BC	20nH Coil Craft
PCB	125871	

NOT FOR

Evaluation Board Schematic

(2110MHz to 2170MHz Application Circuit)

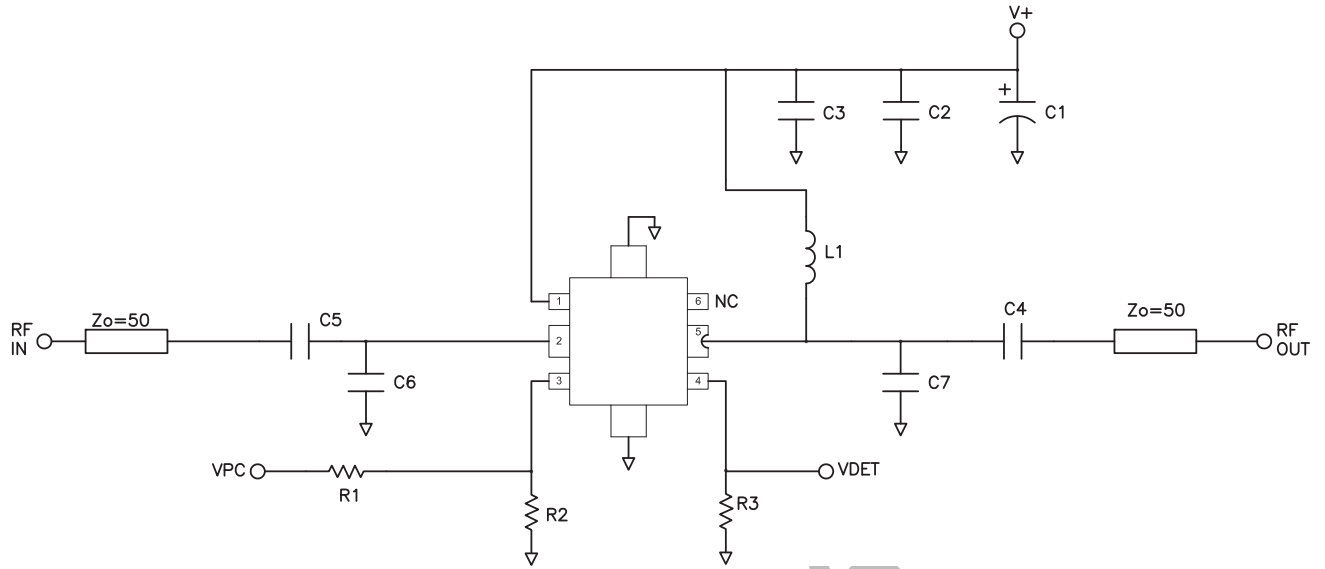

NOT FOR NEW DESIGN

Evaluation Board Schematic and Bill of Materials

2110MHz to 2170MHz Application Circuit (V_{CC} and $V_{PC}=5.0V$)

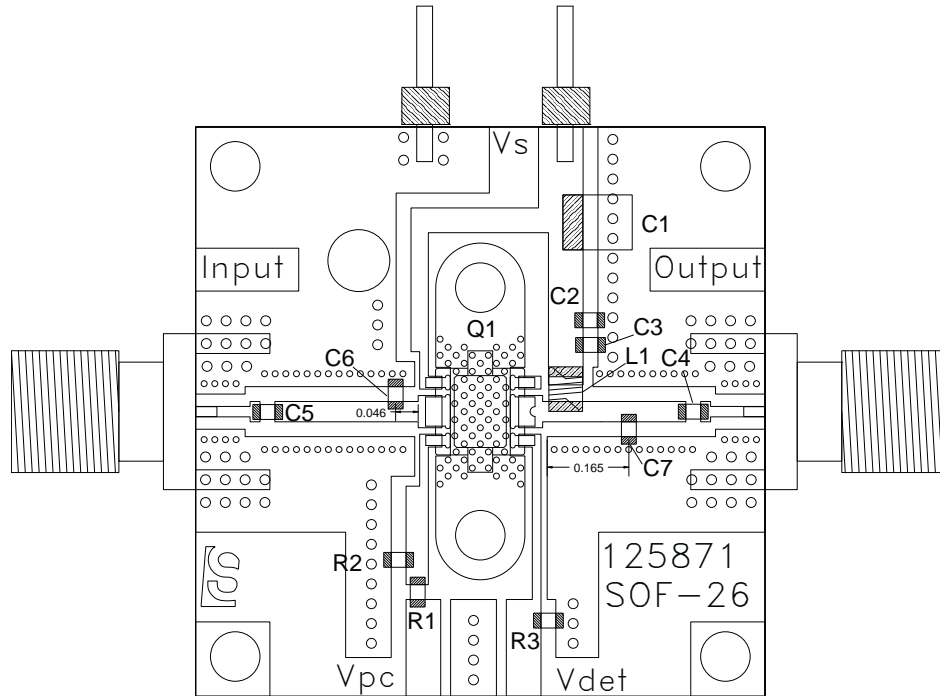

Bill of Materials

Q1	SPA1526Z	
R1	825ohm 1%	
R2	4.32K ohm 1%	
R3	47k ohm	
C1	TAJA106K020R	10.0uF
C2	MCH185CN104KK	0.1uF
C3	06035J8R2BBT	8.2pF AVX
C4	06035J8R2BBT	8.2pF AVX
C5	06035J8R2BBT	8.2pF AVX
C6	06035J3R3BBT	3.3pF AVX
C7	06035J2R4BBT	2.4pF AVX
L1	0805HQ-20NX_BC	20nH Coil Craft
PCB	125871	

NOT FOR

Pin	Function	Description
1	VBIAS	This is the supply voltage for the active bias circuit.
2	RF IN	This is the RF input pin and has a DC voltage present. An external DC block is required.
3	VPC	Power up/down control pin. The voltage on this pin should never exceed the voltage on pin 1 by more than 0.5V unless the supply current from pin 3 is limited < 10mA.
4	VDET	This is the output port for the power detector. It samples the power at the input of the amplifier.
5	RF OUT/VCC	This is the RF output pin and DC connection to the collector.
6	NC	Not connected
GND	GND	These pins are DC-connected to the backside paddle. They provide good thermal connection to the backside paddle for hand soldering and rework. Many thermal and electrical GND vias are required as shown in the recommended land pattern.

Suggested Pad Layout

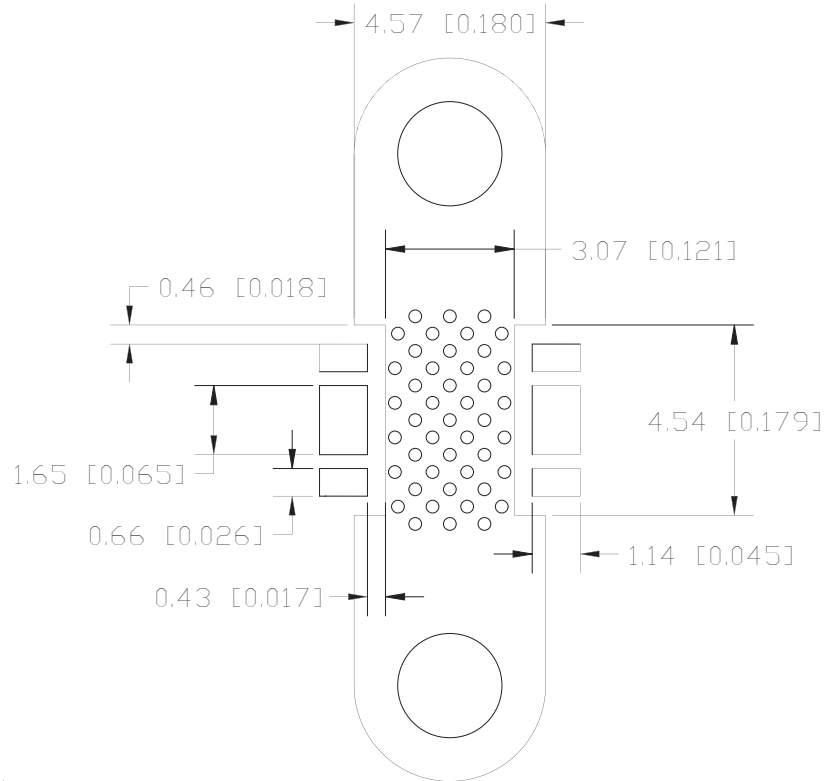

NOT FOR

Package Drawing

Dimensions in inches (millimeters)

Refer to drawing posted at www.rfmd.com for tolerances.

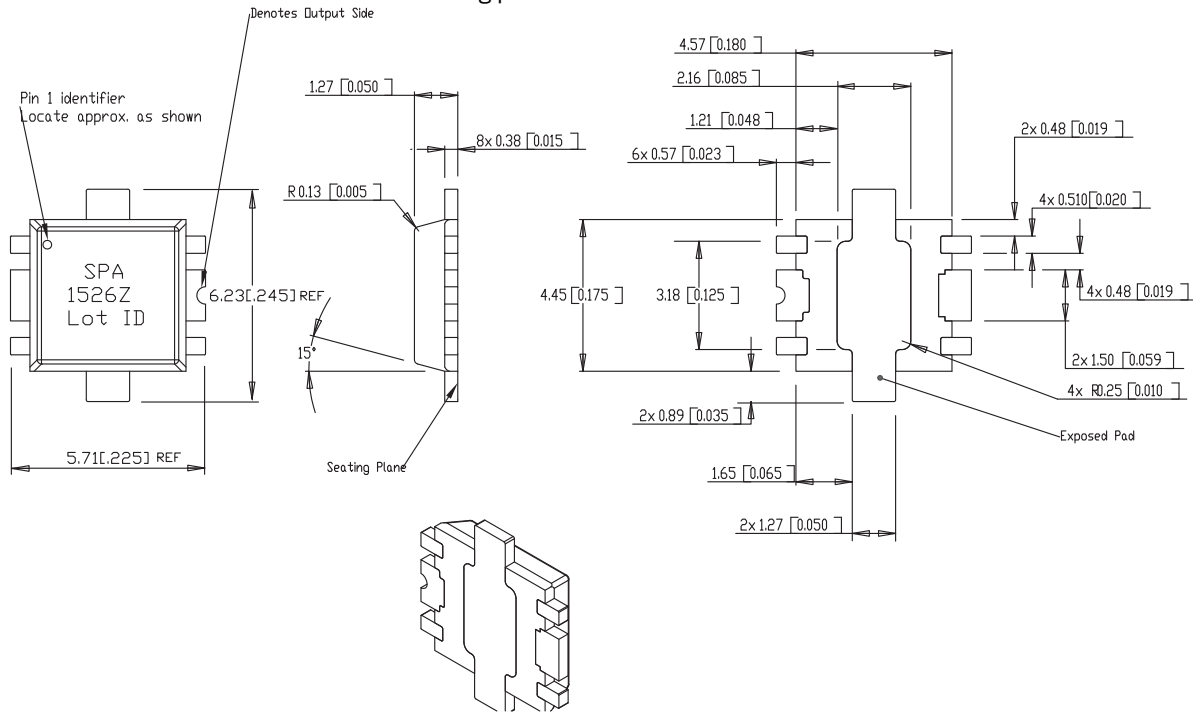

Ordering Information

Ordering Code	Description
SPA1526Z	7" Reel with 1000 pieces
SPA1526ZSQ	Sample Bag with 25 pieces
SPA1526ZSR	7" Reel with 100 pieces
SPA1526ZPCK1	850MHz to 910MHz PCBA with 5 piece Sample Bag
SPA1526ZPCK2	1930MHz to 1960MHz PCBA with 5 piece Sample Bag
SPA1526ZPCK3	2110MHz to 2170 MHz PCBA with 5 piece Sample Bag