

Push Switch 4.5mm-travel Push-push Type

SPED2 Series

www.DataSheet4U.com



Smooth and linear operation feeling.

Detector

Push

Slide

Rotary

Encoders

Power

Dual-in-line
Package Type

TACT Switch™

Custom-
Products

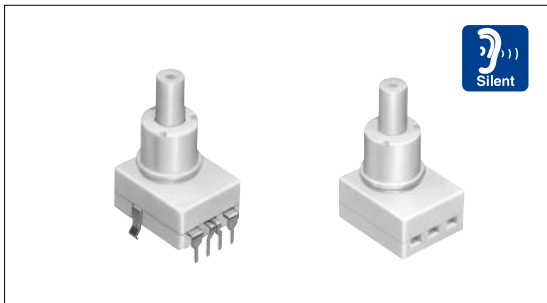

Typical Specifications

Items	Specifications
Ratings	1A 14.5V DC
Contact resistance (Initial performance)	100m max.
Operating force	4.17 ± 0.74N
Operating life(Without load)	30,000cycles
Circuit configuration	2-poles, 1-position
Travel	4.5mm

Product Line

Changeover timing	Travel (mm)	Total travel (mm)	Rating	Mounting method	Poles	Operation	Terminal type	Minimum order unit(pcs.)	Product No.	Drawing No.
Non shorting		4.5		PC board	2	Alternate	For PC board	1,120	SPED220200	1
				Connector				2,000	SPED210200	2

Horizontal
Type

Vertical
Type

Dimensions









Unit:mm

No.	Style	PC board mounting dimensions (Viewed from the mounting face side)
1		
2		

Notes

1. Factory setting for contact points can be either ① or ②.
2. Please place purchase orders per minimum order unit (integer).

List of Varieties

Series		SPPH4	SPPH1	SPEC	SPED2	SPED3	SPED4	SPED5	SPEF		
Photo											
Travel (mm)		2.2	1.5	2.5					1.5		
Total travel (mm)		3	2.5	3.4	4.5	3.8		2.7			
Number of poles		2				1					
Dimensions (mm)	W	8.5	10	12	14			13.5	9.4		
	D	6.5	10		16.8	18		18.2	9		
	H	8.5		12.5	26.7	20.7			6.9		
Operating temperature range		- 10°C to + 60°C			- 40°C to + 85°C						
Rating (max.) Resistive load)		0.1A 30V DC				1A 14.5V DC					
Rating (min.) Resistive load)		50μA 3V DC									
Electrical performance	Initial contact resistance	100m max.	20m max.	30m max.	100m max.						
	Insulation resistance	100M min. 500V DC				3M min. 500V DC			3M min. 100VDC		
	Voltage proof	500V AC for 1minute				100V AC for 1minute					
Mechanical performance	Terminal strength	5N for 1minute		3N for 1minute							
	Actuator strength	Operating direction	30N	50N				90N			
Pulling direction		10N	50N						30N		
Durability	Operating life without load	10,000cycles 100m max.	10,000cycles 40m max.	10,000cycles 50m max.	30,000cycles 100m max.						
	Operating life without load Load:as rating										
Environmental performance	Cold	-20 ± 2 for 96h				-40 ± 2 for 96h					
	Dry heat	85 ± 2 for 96h									
	Damp heat	40 ± 2 , 90 to 95%RH for 96h									
Soldering	Manual soldering	350 ± 10 3 ⁺¹ 0s			350 ± 10 3 ± 0.5s	3	350 ± 10 3 ± 0.5s	350 ± 5 3s max.			
	Dip soldering	260 ± 5 5 ± 1s	260 ± 5 10 ± 1s	260 max. 5s max.	260 ± 5 10 ± 1s	3	260 ± 5 10 ± 1s	260 ± 5 10 ± 1s 4			
	Reflow soldering									Please see P.108	
Page		98	99	101	102	103		105			

Detector

Push

Slide

Rotary

Encoders

Power

Dual-in-line Package Type

TACT Switch™

Custom-Products

Horizontal Type

Vertical Type

Push Switches Attached Parts107
 Push Switches Products Caution109

Notes

3. Applicable to SPED220200(PC board type)only.
4. Applicable to SPEF110100 only.