



## SPFD5408B

---

### 720-channel 6-bit Source Driver with System-on-chip for Color Amorphous TFT-LCDs

***Preliminary***

DEC. 24, 2007

Version 0.4

## Table of Contents

	<u>PAGE</u>
<b>1. GENERAL DESCRIPTION</b> .....	<b>5</b>
<b>2. FEATURE</b> .....	<b>5</b>
<b>3. ORDERING INFORMATION</b> .....	<b>5</b>
<b>4. BLOCK DIAGRAM</b> .....	<b>6</b>
<b>5. SIGNAL DESCRIPTIONS</b> .....	<b>8</b>
<b>6. INSTRUCTIONS</b> .....	<b>12</b>
6.1. OUTLINE.....	12
6.2. INSTRUCTION.....	13
6.2.1. Index Register (IR).....	14
6.2.2. ID Read Register (SR).....	14
6.2.3. Driver Output Control Register (R01h).....	14
6.2.4. LCD Driving Waveform Control (R02h).....	15
6.2.5. Entry Mode (R03h).....	15
6.2.6. Scaling Control register (R04h).....	16
6.2.7. Display Control (R07h).....	16
6.2.8. Display Control 2 (R08h).....	17
6.2.9. Display Control 3 (R09h).....	18
6.2.10. Frame Cycle Control (R0Ah).....	19
6.2.11. External Display Interface Control 1 (R0Ch).....	20
6.2.12. Frame Maker Position (R0Dh).....	21
6.2.13. External Display Interface Control 2 (R0Fh).....	21
6.2.14. Power Control 1 (R10h).....	22
6.2.15. Power Control 2 (R11h).....	23
6.2.16. Power Control 3 (R12h).....	24
6.2.17. Power Control 4 (R13h).....	25
6.2.18. GRAM Address Set (Horizontal Address) (R20h).....	26
6.2.19. GRAM Address Set (Vertical Address) (R21h).....	26
6.2.20. Write Data to GRAM (R22h).....	27
6.2.21. Read Data Read from GRAM (R22h).....	30
6.2.22. NVM read data 1 (R28h).....	30
6.2.23. NVM read data 2 (R29h).....	30
6.2.24. NVM read data 3 (R2Ah).....	31
6.2.25. $\gamma$ Control (R30h to R3Fh).....	32
6.2.26. Window Horizontal RAM Address Start (R50h).....	32
6.2.27. Window Horizontal RAM Address End (R51h).....	32
6.2.28. Window Vertical RAM Address Start (R52h).....	33
6.2.29. Window Vertical RAM Address End (R53h).....	33
6.2.30. Driver Output Control (R60h).....	33
6.2.31. Driver Output Control (R61h).....	35
6.2.32. Vertical Scroll Control (R6Ah).....	35
6.2.33. Display Position – Partial Display 1 (R80h).....	35
6.2.34. RAM Address Start – Partial Display 1 (R81h).....	35
6.2.35. RAM Address End – Partial Display 1 (R82h).....	36

6.2.36. Display Position – Partial Display 2 (R83h).....	36
6.2.37. RAM Address Start – Partial Display 2 (R84h).....	36
6.2.38. RAM Address End – Partial Display 2 (R85h).....	36
6.2.39. Panel Interface Control 1 (R90h).....	36
6.2.40. Panel Interface Control 2 (R92h).....	37
6.2.41. Panel Interface control 3 (R93h).....	38
6.2.42. Panel Interface control 4 (R95h).....	38
6.2.43. Panel Interface Control 5 (R97h).....	40
6.2.44. Panel Interface Control 6 (R98h).....	41
6.2.45. Calibration Control (RA4h).....	41
<b>7. GRAM.....</b>	<b>42</b>
<b>8. INTERFACES.....</b>	<b>44</b>
8.1. SYSTEM INTERFACE.....	44
8.1.1. 80-system 18-bit interface.....	45
8.1.2. 80-system 16-bit interface.....	45
8.1.3. 80-system 9-bit interface.....	45
8.1.4. 80-system 8-bit interface.....	45
8.1.5. Serial Peripheral interface (SPI).....	46
8.2. VSYNC INTERFACE.....	47
8.3. EXTERNAL DISPLAY INTERFACE.....	48
8.3.1. 6-bit RGB interface.....	49
8.3.2. 16-bit RGB interface.....	50
8.3.3. 18-bit RGB interface.....	50
8.4. SEQUENCE TO SET BETWEEN SYSTEM INTERFACE AND RGB INTERFACE:.....	51
<b>9. DISPLAY FEATURE FUNCTION:.....</b>	<b>52</b>
9.1. FMARK FUNCTION:.....	52
9.2. SCAN MODE FUNCTION:.....	53
9.3. SCALING FUNCTION:.....	54
9.4. PARTIAL DISPLAY FUNCTION:.....	56
9.5. GAMMA CORRECTION FUNCTIONS:.....	58
<b>10. POWER MANAGEMENT SYSTEM:.....</b>	<b>59</b>
<b>11. APPLICATION CIRCUITS:.....</b>	<b>62</b>
<b>12. INITIAL CODE:.....</b>	<b>63</b>
<b>13. POWER ON/OFF SEQUENCE.....</b>	<b>64</b>
13.1. POWER ON/OFF SEQUENCE DIAGRAM.....	64
13.2. DISPLAY ON/OFF SEQUENCE:.....	65
13.3. SEQUENCE TO EXIT SLEEP MODE:.....	66
<b>14. ELECTRICAL CHARACTERISTICS:.....</b>	<b>67</b>
14.1. ABSOLUTE MAXIMUM RATINGS:.....	67
14.2. DC CHARACTERISTICS.....	67
14.3. AC CHARACTERISTICS.....	68
14.3.1. Clock Characteristics.....	68
14.3.2. 80-System Bus Interface Timing Characteristics (18-/ 16- bit interface).....	68
14.3.3. Clock-synchronized Serial Interface Timing Characteristics.....	70
14.3.4. Reset Timing Characteristics (IOVCC=1.65~3.30V).....	70

---

14.3.5. RGB Interface Timing Characteristics .....	71
<b>15. CHIP INFORMATION .....</b>	<b>72</b>
15.1. PAD ASSIGNMENT .....	72
15.2. PAD DIMENSION .....	72
15.2.1. Output Pads .....	72
15.2.2. Input Pads .....	72
15.3. BUMP CHARACTERISTICS .....	73
15.4. PAD LOCATIONS .....	74
15.5. ALIGNMENT MARK .....	82
<b>16. DISCLAIMER .....</b>	<b>83</b>
<b>17. REVISION HISTORY .....</b>	<b>84</b>

ORISE Tech Confidential  
For 昭揚電子 Use Only

## 720-CHANNEL DRIVER WITH SYSTEM-ON-CHIP (SOC) FOR COLOR AMORPHOUS TFT LCD

### 1. GENERAL DESCRIPTION

The SPFD5408B, a 262144-color System-on-Chip (SoC) driver LSI designed for small and medium sizes of TFT LCD display, is capable of supporting up to 240xRGBx320 in resolution which can be achieved by the designated RAM for graphic data. The 720-channel source driver has true 6-bit resolution, which generates 64 Gamma-corrected values by an internal D/A converter.

The SPFD5408B is able to operate with low IO interface power supply up to 1.65V and incorporate with several charge pumps to generate various voltage levels that form an on-chip power management system for gate driver and source driver.

The built-in timing controller in SPFD5408B can support several interfaces for the diverse request of medium or small size portable display. SPFD5408B provides system interfaces, which include 8-/9-/16-/18-bit parallel interfaces and serial interface (SPI), to configure system. Not only can the system interfaces be used to configure system, they can also access RAM at high speed for still picture display. In addition, the SPFD5408B incorporates 6, 16, and 18-bit RGB interfaces for picture movement display. The SPFD5408B also supports a function to display eight colors and a standby mode for power control consideration.

### 2. FEATURE

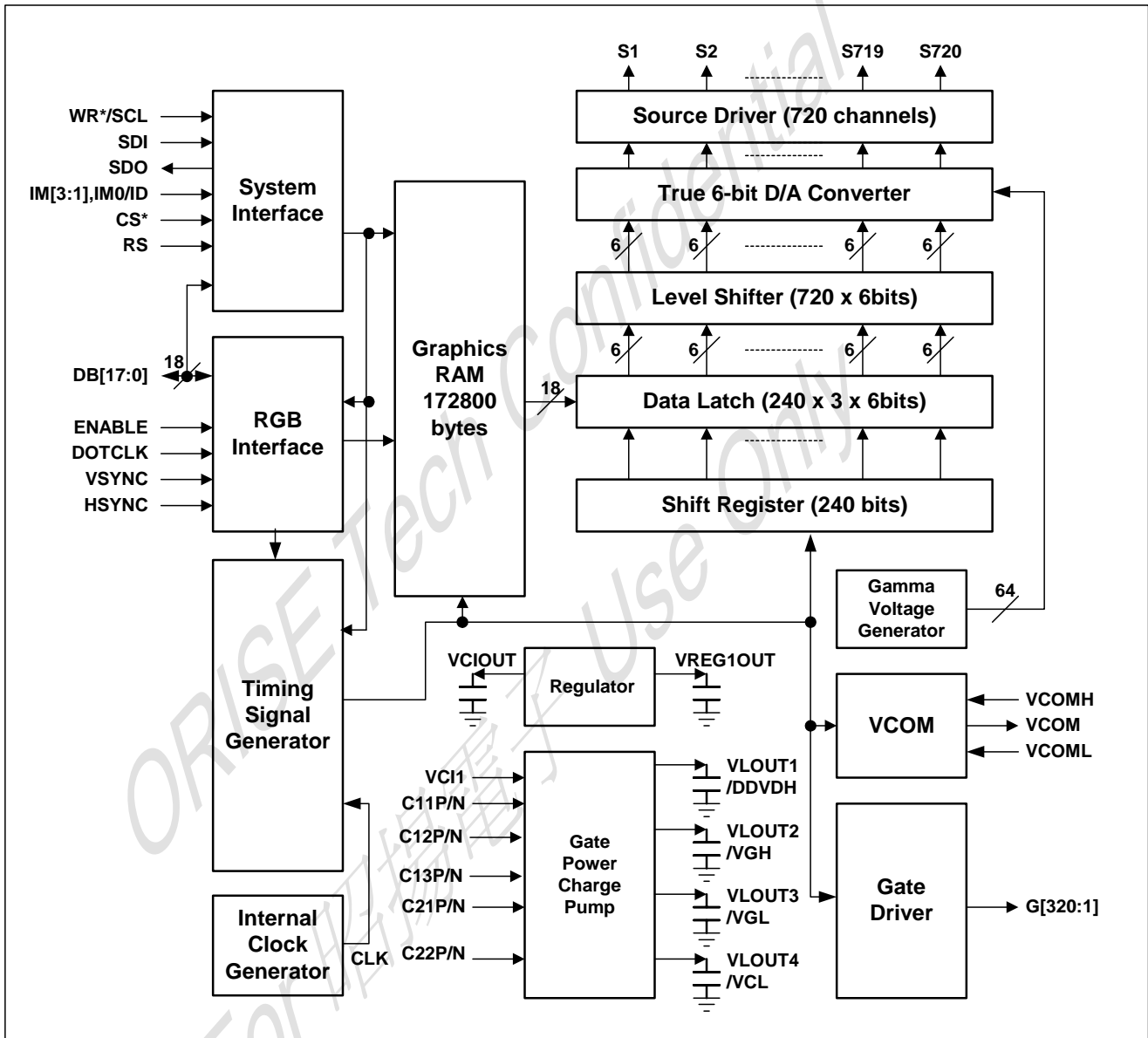
- One-chip solution for amorphous TFT-LCD.
- Supports resolution up to 240xRGBx320, incorporating a 720-channel source driver and a 320-channel gate driver
- Outputs 64  $\gamma$ -corrected values using an internal true 6-bit resolution D/A converter to achieve 262K colors
- Built-in 172800 bytes internal RAM
- Line Inversion AC drive / frame inversion AC drive
- System interfaces
  - High-speed interfaces to 8-, 9-, 16-, and 18-bit parallel ports
  - Serial Peripheral Interface (SPI)
- Interfaces for moving picture display
  - 6-, 16-, and 18-bit RGB interfaces
- Diverse RAM accessing for functional display
  - Window address function to display at any area on the screen via a moving picture display interface
  - Window address function to limit the data rewriting area and reduce data transfer
  - Moving and still picture can display at the same time
  - Vertical scrolling function
  - Partial screen display
- Power supply
  - I/O interface supply voltage (IOVcc): 1.65 ~ 3.3 V
  - Analog power supply voltage (Vci): 2.5 ~ 3.3 V
- Resize function( x 1/2, x 1/4)
- On-chip power management system
  - Power saving mode (standby / 8-color mode, etc)
  - Low power consumption structure for source driver.
- Built-in Charge Pump circuits
  - Source driver voltage level: DDVDH-GND=4.5V ~ 6V.
  - Gate driver voltage level (VGH, VGL)
    - VGH = 10.0V ~20.0V
    - VGL = -4.5V ~ -13.5V
    - VGH – VGL < 28.0V
  - Built-in internal oscillator and hardware reset

### 3. ORDERING INFORMATION

Product Number	Package Type
SPFD5408B-C3	Chip Form with Gold Bump (thickness 400um)

## 4. BLOCK DIAGRAM

### 4.1. Block Function



## 4.2. System Interface

### 4.2.1. The SPFD5408B supports three high-speed system interfaces:

1. 80-system high-speed interfaces with 8-, 9-, 16-, 18-bit parallel ports.
2. Serial Peripheral Interface (SPI).

The SPFD5408B has a 16-bit index register (IR) and two 18-bit data registers, a write-data register (WDR) and a read-data register (RDR). The IR register is used to store index information from control registers. The WDR register is used to temporarily store data to be written for register control and internal GRAM. The RDR register is used to temporarily store data read from the GRAM. When graphic data is written to the internal GRAM from MCU/graphic engine, the data is first written to the WDR and then automatically written to the internal GRAM in internal operation. When graphic data read operation is executed, graphic data is read via the RDR from the internal GRAM. Therefore, invalid data is first read out to the data bus when the SPFD5408B executes the 1<sup>st</sup> read operation. Thus, valid data can be read out after the SPFD5408B executes the 2<sup>nd</sup> read operation.

### 4.2.2. External Display Interface

The SPFD5408B supports external RGB interface for picture movement display.

The SPFD5408B allows switching between one of the external display interfaces and the system interface via pin configuration so that the optimum interface is selected for still / moving picture displayed on the screen.

When the RGB interface is chosen, display operations are synchronized with external supplied signals, VSYNC, HSYNC, and DOTCLK. Moreover, valid display data (DB17-0) is written to GRAM, which synchronized with signal (DE) enabling.

### 4.2.3. Address Counter (AC)

SPFD5408B features an Address Counter (AC) giving an address to the internal GRAM. The address in the AC is automatically updated plus or minus 1. The window address function enables writing data only in the rectangular area arbitrarily set by users on the GRAM.

### 4.2.4. Graphics RAM (GRAM)

SPFD5408B features a 172800-byte (240 x 320 x 18 / 8) Graphic RAM (GRAM).

### 4.2.5. Grayscale Voltage Generating Circuit

SPFD5408B has true 6-bit resolution D/A converter, which generates 64 Gamma-corrected values and cooperates with OP-AMP structure to enhance display quality. The grayscale voltage can be adjusted by grayscale data set in the  $\gamma$ -correction register.

### 4.2.6. Timing Controller

SPFD5408B has a timing controller, which can generate a timing signal for internal circuit operation such as gate output timing, RAM accessing timing, etc.

### 4.2.7. Oscillator (OSC)

The SPFD5408B also features an internal oscillator to generate RC oscillation with an internal resistor. In standby mode, RC oscillation is halted to reduce power consumption.

### 4.2.8. Source Driver Circuit

SPFD5408B consists of a 720-output source driver circuit (S1 ~ S720). Data in the GRAM are latched when the 720<sup>th</sup> bit data is input. The latched data controls the source driver and generates a drive waveform.

### 4.2.9. Gate Driver Circuit

SPFD5408B consists of a 320-output gate driver circuit (G1~G320). The gate driver circuit outputs gate driver signals at either VGH or VGL level.

### 4.2.10. LCD Driving Power Supply Circuit

The LCD driving power supply circuit generates the voltage levels DDVDH, VGH, VGL and VCOM for driving an LCD. All this voltages can be adjusted by register setting.

**5. SIGNAL DESCRIPTIONS**

Signal	Pin No.	I/O	Connected with	Function																																																																																																																
<b>System Configuration Input Signal</b>																																																																																																																				
IM3~1, IM0/ID	4	I	GND/ IOVCC	Select a mode to interface to an MPU. In serial interface operation, the IM0 pin is used to set the ID bit of device code.																																																																																																																
				<table border="1"> <thead> <tr> <th>IM3</th> <th>IM2</th> <th>IM1</th> <th>IM0/ID</th> <th>Interface Mode</th> <th>DB Pin</th> <th>Colors</th> </tr> </thead> <tbody> <tr> <td>0</td> <td>0</td> <td>0</td> <td>0</td> <td>Setting disabled</td> <td>-</td> <td>-</td> </tr> <tr> <td>0</td> <td>0</td> <td>0</td> <td>1</td> <td>Setting disabled</td> <td>-</td> <td>-</td> </tr> <tr> <td>0</td> <td>0</td> <td>1</td> <td>0</td> <td>80-system 16-bit interface</td> <td>DB17-10, DB8-1</td> <td>262,144 see Note 1</td> </tr> <tr> <td>0</td> <td>0</td> <td>1</td> <td>1</td> <td>80-system 8-bit interface</td> <td>DB17-10</td> <td>262,144 see Note 2</td> </tr> <tr> <td>0</td> <td>1</td> <td>0</td> <td>*(ID)</td> <td>Clock synchronous serial interface</td> <td>-</td> <td>65,536</td> </tr> <tr> <td>0</td> <td>1</td> <td>1</td> <td>0</td> <td>Setting disabled</td> <td>-</td> <td>-</td> </tr> <tr> <td>0</td> <td>1</td> <td>1</td> <td>1</td> <td>Setting disabled</td> <td>-</td> <td>-</td> </tr> <tr> <td>1</td> <td>0</td> <td>0</td> <td>0</td> <td>Setting disabled</td> <td>-</td> <td>-</td> </tr> <tr> <td>1</td> <td>0</td> <td>0</td> <td>1</td> <td>Setting disabled</td> <td>-</td> <td>-</td> </tr> <tr> <td>1</td> <td>0</td> <td>1</td> <td>0</td> <td>80-system 18-bit interface</td> <td>DB17-0</td> <td>262,144</td> </tr> <tr> <td>1</td> <td>0</td> <td>1</td> <td>1</td> <td>80-system 9-bit interface</td> <td>DB17-9</td> <td>262,144</td> </tr> <tr> <td>1</td> <td>1</td> <td>0</td> <td>0</td> <td>Setting disabled</td> <td>-</td> <td>-</td> </tr> <tr> <td>1</td> <td>1</td> <td>0</td> <td>1</td> <td>Setting disabled</td> <td>-</td> <td>-</td> </tr> <tr> <td>1</td> <td>1</td> <td>1</td> <td>0</td> <td>Setting disabled</td> <td>-</td> <td>-</td> </tr> <tr> <td>1</td> <td>1</td> <td>1</td> <td>1</td> <td>Setting disabled</td> <td>-</td> <td>-</td> </tr> </tbody> </table>	IM3	IM2	IM1	IM0/ID	Interface Mode	DB Pin	Colors	0	0	0	0	Setting disabled	-	-	0	0	0	1	Setting disabled	-	-	0	0	1	0	80-system 16-bit interface	DB17-10, DB8-1	262,144 see Note 1	0	0	1	1	80-system 8-bit interface	DB17-10	262,144 see Note 2	0	1	0	*(ID)	Clock synchronous serial interface	-	65,536	0	1	1	0	Setting disabled	-	-	0	1	1	1	Setting disabled	-	-	1	0	0	0	Setting disabled	-	-	1	0	0	1	Setting disabled	-	-	1	0	1	0	80-system 18-bit interface	DB17-0	262,144	1	0	1	1	80-system 9-bit interface	DB17-9	262,144	1	1	0	0	Setting disabled	-	-	1	1	0	1	Setting disabled	-	-	1	1	1	0	Setting disabled	-	-	1	1	1	1	Setting disabled	-	-
				IM3	IM2	IM1	IM0/ID	Interface Mode	DB Pin	Colors																																																																																																										
				0	0	0	0	Setting disabled	-	-																																																																																																										
				0	0	0	1	Setting disabled	-	-																																																																																																										
				0	0	1	0	80-system 16-bit interface	DB17-10, DB8-1	262,144 see Note 1																																																																																																										
				0	0	1	1	80-system 8-bit interface	DB17-10	262,144 see Note 2																																																																																																										
				0	1	0	*(ID)	Clock synchronous serial interface	-	65,536																																																																																																										
				0	1	1	0	Setting disabled	-	-																																																																																																										
				0	1	1	1	Setting disabled	-	-																																																																																																										
				1	0	0	0	Setting disabled	-	-																																																																																																										
				1	0	0	1	Setting disabled	-	-																																																																																																										
				1	0	1	0	80-system 18-bit interface	DB17-0	262,144																																																																																																										
				1	0	1	1	80-system 9-bit interface	DB17-9	262,144																																																																																																										
				1	1	0	0	Setting disabled	-	-																																																																																																										
1	1	0	1	Setting disabled	-	-																																																																																																														
1	1	1	0	Setting disabled	-	-																																																																																																														
1	1	1	1	Setting disabled	-	-																																																																																																														
Notes: 1. 65,536 colors in one transfer mode 2. 65,536 colors in two transfers mode																																																																																																																				
/RESET	1	I	MPU or external RC circuit	RESET pin. This is an active low signal.																																																																																																																
<b>Interface input Signals</b>																																																																																																																				
/CS	1	I	MPU	Chip select signal. Low: the SPFD5408B is accessible High: the SPFD5408B is not accessible Must connect to the GND or IOVCC level when not used. This pin has weak pull high/low resistors and can be modified to high / low by metal layer change for customer's request.																																																																																																																
RS	1	I	MPU	Register select signal. Low: Index register or internal status is selected. High: Control register is selected. Must connect to the GND or IOVCC level when not used. This pin has weak pull high/low resistors and can be modified to high / low by metal layer change for customer's request.																																																																																																																
(/WR) / (SCL)	1	I	MPU	(A) In 80-system interface mode, a write strobe signal can be input via this pin and initializes a write operation when the signal is low. (B) In SPI mode, served as a synchronizing clock signal.																																																																																																																



Signal	Pin No.	I/O	Connected with	Function																
				This pin has weak pull high/low resistors and can be modified to high / low by metal layer change for customer's request.																
/RD	1	I	MPU	In 80-system interface mode, a read strobe signal can be input via this pin and initializes a read operation when the signal is low. Must connect to the GND or IOVCC level when not in use. This pin has weak pull high/low resistors and can be modified to high / low by metal layer change for customer's request.																
SDI	1	I	MPU	Series Data is the input on the rising edge of the SCL signal in SPI mode. Must connect to the GND or IOVCC level when not in use. This pin has weak pull high/low resistors and can be modified to high / low by metal layer change for customer's request.																
SDO	1	O	MPU	Series Data is the output on the rising edge of the SCL signal in SPI mode.																
DB0-DB17	1	I/O	MPU	Served as an 18-bit parallel bi-directional data bus. Data bus pin assignment corresponding to different modes are summarized in the table: <table border="1" data-bbox="703 891 1449 1211"> <thead> <tr> <th>Mode</th> <th>Pin Assignment</th> </tr> </thead> <tbody> <tr> <td>8-bit system interface</td> <td>DB17-DB10</td> </tr> <tr> <td>9-bit system interface</td> <td>DB17-DB9</td> </tr> <tr> <td>16-bit system interface</td> <td>DB17-DB10, DB8-DB1</td> </tr> <tr> <td>18-bit system interface</td> <td>DB17-DB0</td> </tr> <tr> <td>6-bit External (RGB) interface</td> <td>DB17-DB12</td> </tr> <tr> <td>16-bit External (RGB) interface</td> <td>DB17-13, DB11-DB1</td> </tr> <tr> <td>18-bit External (RGB) interface</td> <td>DB17-DB0</td> </tr> </tbody> </table> Must connect to the GND or IOVCC level when not in use. These pins have weak pull high/low resistors and can be modified to high / low by metal layer change for customer's request.	Mode	Pin Assignment	8-bit system interface	DB17-DB10	9-bit system interface	DB17-DB9	16-bit system interface	DB17-DB10, DB8-DB1	18-bit system interface	DB17-DB0	6-bit External (RGB) interface	DB17-DB12	16-bit External (RGB) interface	DB17-13, DB11-DB1	18-bit External (RGB) interface	DB17-DB0
Mode	Pin Assignment																			
8-bit system interface	DB17-DB10																			
9-bit system interface	DB17-DB9																			
16-bit system interface	DB17-DB10, DB8-DB1																			
18-bit system interface	DB17-DB0																			
6-bit External (RGB) interface	DB17-DB12																			
16-bit External (RGB) interface	DB17-13, DB11-DB1																			
18-bit External (RGB) interface	DB17-DB0																			
VSYNC	1	I	MPU	In external interface mode, served as a vertical synchronize signal input Must connect to the IOVCC or GND level when not in use. This pin has weak pull high/low resistors and can be modified to high / low by metal layer change for customer's request.																
HSYNC	1	I	MPU	In external interface mode, served as a horizontal synchronized signal input Must connect to the IOVCC or GND level when not used. This pin has weak pull high/low resistors and can be modified to high / low by metal layer change for customer's request.																
ENABLE	1	I	MPU	In external interface mode, polarity of ENABLE signal is synchronized with valid graphic data input. Low: Valid data on DB17-DB0 High: Invalid data on DB17-DB0 Moreover, setting EPL bit can change the polarity of the ENABLE signal. Must connect to the GND or IOVCC level when not in use. This pin has weak pull high/low resistors and can be modified to high / low by metal layer change for customer's request.																
DOTCLK	1	I	MPU	In external interface mode, served as a dot clock signal. When DPL = "0": Input data on the rising edge of DOTCLK When DPL = "1": Input data on the falling edge of DOTCLK It is fixed to the IOVCC level when not in use.																

Signal	Pin No.	I/O	Connected with	Function
				This pin has weak pull high/low resistors and can be modified to high / low by metal layer change for customer's request.
FMARK	1	O	MPU	Frame head pulse signal, which is used when writing data to the internal RAM. Keep this pin open when not used.
<b>Charge Pump and Power Supply Signal</b>				
C11P/N, C12P/N C13P/N C21P/N, C22P/N	12	-	Step-up capacitor	Connect boost capacitors for the internal DC/DC converter circuit to these pins. Leave the pins open when DC/DC converter circuits are not used.
VCI1	1	I/O	Stabilizing capacitor	Reference voltage of step-up circuit 1. Make sure the output voltage levels from DDVDH, VGH, and VGL do not exceed the respective setting ranges.
DDVDH	1	I	Stabilizing capacitor	Power supply for the source driver liquid crystal drive unit and VCOM drive. DDVDH = 4.5V ~ 6.0V
VGH	1	I	Stabilizing capacitor	Liquid crystal drive power supply.
VGL	1	I	Stabilizing capacitor	Liquid crystal drive power supply.
VCL	1	O	Stabilizing capacitor	VCOML drive power supply. Make sure to connect to stabilizing capacitor. VCL = -1.9V ~ -3.0V
VPP2		I	Power supply or open	Power supply.
<b>Source/Gate Driver and VCOM Signals</b>				
G1~G320	320	O	LCD	Output gate driver signals, which has the swing from VGH to VGL.
S1~S720	720	O	LCD	Output source driver signals. The D/A converted 64-gray-scale analog voltage is output.
VREG1 OUT	1	O	Stabilizing capacitor	Output voltage generated from the reference voltage (VCI or VCIR). The factor is determined by instruction (VRH bits). VREG1OUT is used for (1) source driver grayscale reference voltage, (2) VCOMH level reference voltage, and (3) VCOM amplitude reference voltage. Connect to a stabilizing capacitor when in use. VREG1OUT = 4.0V ~ (DDVDH - 0.5)V
VCOM	1	O	TFT panel common electrode	Power supply to TFT panel's common electrode. VCOM alternates between VCOMH and VCOML. The alternating cycle is set by internal register. Also, the VCOM output can be started and halted by register setting.
VCOMH	1	O	Stabilizing capacitor	The High level of VCOM amplitude. The output level can be adjusted by electronic volume. Make sure to connect to stabilizing capacitor.
VCOML	1	O	Stabilizing capacitor	The Low level of VCOM amplitude. The output level can be adjusted by instruction (VDV bits). VCOML = (VCL+0.5) V ~ 0V. Make sure to connect to stabilizing capacitor.
VGS	1	I	GND	Reference level for the grayscale voltage generating circuit.
GND	1	-	Power supply	Internal logic GND: GND = 0V.
RGND	1	-	Power supply	Internal RAM GND. RGND must be at the same electrical potential as GND. In case of COG, connect to GND on the FPC to prevent noise.
VDDD	1	O	Stabilizing capacitor	Internal logic regulator output, which is used as the power supply to internal logic. Connect a stabilizing capacitor.
IOVCC	1	-	Power supply	Power supply to the interface pins: RESET*, CS*, WR, RD*, RS, DB17-0.

Signal	Pin No.	I/O	Connected with	Function
				VSYNC, HSYNC, DOTCLK, ENABLE. IOVCC = 1.65V ~ 3.3V. VCC ≥ IOVCC. In case of COG, connect to VCC on the FPC if IOVCC=VCC, to prevent noise.
AGND	1	-	Power supply	Analog GND (for logic regulator and liquid crystal power supply circuit): AGND = 0V. In case of COG, connect to GND on the FPC to prevent noise.
VCI	1	I	Power supply	Power supply to the liquid crystal power supply analog circuit. Connect to an external power supply of 2.5V ~ 3.3V.
<b>Misc. Signal</b>				
IOGNDDUM	3	I/O	Open	Test pins. Leave them open.
DUMMY1~15 DUMMY20~27	10	I/O	Open	Test pins. Leave them open.
TEST02~16	37	I/O	Open	Test pins. Leave them open.
TEST1~3	2	I/O	Open	Test pins. Leave them open.
TS0~8	9	I/O	Open	Test pins. Leave them open

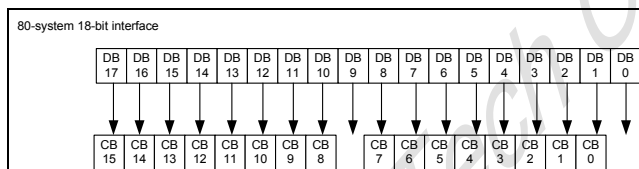
## 6. INSTRUCTIONS

### 6.1. Outline

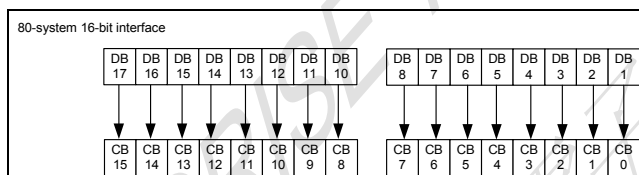
The SPFD5408B supports 18-bit data bus interface to access command register to configure system. When the command register accessing is desired, sending the command information to specify which index register would be accessed and following the data to that control register. Moreover, register accessing operation should cooperate with RS, /WR, /RD signal for SPFD5408B to recognize the control instruction. And command instruction can be accomplished by using all system interfaces (18-bit, 16-bit, 9-bit, 8-bit 80 system and SPI). The corresponding pin assignment of different system interface are shown in **Figure 6-1** to **Figure 6-6**

The instruction can be categorized into 8 groups. And the 8 groups are:

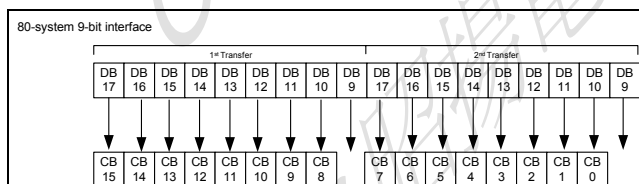
1. Specify the index of register
2. Read a status
3. Display control
4. Power management Control
5. Graphics data processing
6. Set internal GRAM address
7. Transfer data to and from the internal GRAM
8. Internal grayscale  $\gamma$ -correction



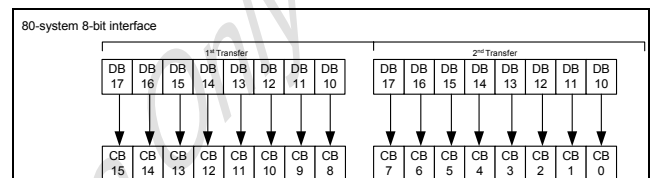
**Figure 6-1**



**Figure 6-2**

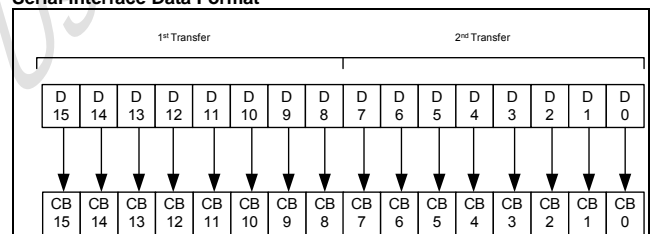


**Figure 6-3**



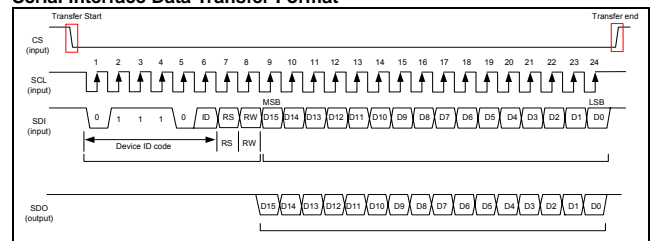
**Figure 6-4**

### Serial interface Data Format



**Figure 6-5**

### Serial interface Data Transfer Format



**Figure 6-6**

**6.2. Instruction**
**Table 6-1 Instruction List Table**

Register No	Register	Upper 8-bit								Lower 8-bit								
		CB15	CB14	CB13	CB12	CB11	CB10	CB9	CB8	CB7	CB6	CB5	CB4	CB3	CB2	CB1	CB0	
00h	ID Read	0	1	0	1	0	1	0	0	0	0	0	1	0	0	0		
01h	Driver Output Control	0	0	0	0	0	SM (0)	0	SS (0)	0	0	0	0	0	0	0		
02h	LCD Drive Waveform Control	0	0	0	0	0	1	B/C (0)	0	0	0	0	0	0	0	0		
03h	Entry Mode	TRIREG (0)	DFM (0)	0	BGR (0)	0	0	0	0	ORG (0)	0	I/D1 (1)	I/D0 (1)	AM (0)	0	0		
04h	Scaling Control	0	0	0	0	0	0	RCV1 (0)	RCV0 (0)	0	0	RCH1 (0)	RCH0 (0)	0	0	RSZ1 (0)	RSZ0 (0)	
07h	Display Control (1)	0	0	PTDE1 (0)	PTDE0 (0)	0	0	0	BASEE (0)	0	0	0	DTE (0)	COL (0)	0	D1 (0)	0	
08h	Display Control (2)	0	0	0	0	FP3 (1)	FP2 (0)	FP1 (0)	FP0 (0)	0	0	0	0	BP3 (1)	BP2 (0)	BP1 (0)	BP0 (0)	
09h	Display Control (3)	0	0	0	0	0	PTS2 (0)	PTS1 (0)	PTS0 (0)	0	0	PTG1 (0)	PTG0 (0)	ISC3 (0)	ISC2 (0)	ISC1 (0)	ISC0 (0)	
0Ah	Frame Cycle Control	0	0	0	0	0	0	0	0	0	0	0	0	FMARKOE (0)	FM12 (0)	FM11 (0)	FM10 (0)	
0Ch	External Display interface control (1)	0	0	0	0	0	0	0	RM (0)	0	0	DM1 (0)	DM0 (0)	0	0	RIM1 (0)	RIM0 (0)	
0Dh	Frame Maker Position	0	0	0	0	0	0	0	FMP8 (0)	FMP7 (0)	FMP6 (0)	FMP5 (0)	FMP4 (0)	FMP3 (0)	FMP2 (0)	FMP1 (0)	FMP0 (0)	
0Fh	External Display interface control (2)	0	0	0	0	0	0	0	0	0	0	0	VSP1 (0)	HSPL (0)	0	EPL (0)	DPL (0)	
10h	Power Control (1)	0	0	0	SAP (0)	0	BT2 (0)	BT1 (0)	BT0 (0)	APE (0)	0	AP1 (0)	AP0 (0)	0	DSTB (0)	SLP (0)	0	
11h	Power Control (2)	0	0	0	0	0	DC12 (0)	DC11 (0)	DC10 (0)	0	DC02 (0)	DC01 (0)	DC00 (0)	0	VC2 (0)	VC1 (0)	VC0 (0)	
12h	Power Control (3)	0	0	0	0	0	0	0	VCMR0 (0)	VREG1R (0)	0	0	0	VRH3 (0)	VRH2 (0)	VRH1 (0)	VRH0 (0)	
13h	Power Control (4)	0	0	0	VDV4 (0)	VDV3 (0)	VDV2 (0)	VDV1 (0)	VDV0 (0)	0	0	0	0	0	0	0	0	
20h	GRAM address Set Horizontal Address	0	0	0	0	0	0	0	0	AD7 (0)	AD6 (0)	AD5 (0)	AD4 (0)	AD3 (0)	AD2 (0)	AD1 (0)	AD0 (0)	
21h	GRAM address Set Vertical Address	0	0	0	0	0	0	0	AD16 (0)	AD15 (0)	AD14 (0)	AD13 (0)	AD12 (0)	AD11 (0)	AD10 (0)	AD9 (0)	AD8 (0)	
22h	Write Data to GRAM Read Data from GRAM																	
28h	NVM read data (1)	0	0	0	0	0	0	0	0	0	0	0	0	0	UID3 (0)	UID2 (0)	UID1 (0)	UID0 (0)
29h	NVM read data (2)	0	0	0	0	0	0	0	0	0	0	0	0	VCM14 (0)	VCM13 (0)	VCM12 (0)	VCM11 (0)	VCM10 (0)
2Ah	NVM read data (3)	0	0	0	0	0	0	0	0	VCMSEL (0)	0	0	0	VCM24 (0)	VCM23 (0)	VCM22 (0)	VCM21 (0)	VCM20 (0)
30h	$\gamma$ Control (1)	0	0	0	V1RP4	V1RP3	V1RP2	V1RP1	V1RP0	0	0	0	V6RN4	V6RN3	V6RN2	V6RN1	V6RN0	
31h	$\gamma$ Control (2)	0	0	V2RP5	V2RP4	V2RP3	V2RP2	V2RP1	V2RP0	0	0	V5RN5	V5RN4	V5RN3	V5RN2	V5RN1	V5RN0	
32h	$\gamma$ Control (3)	0	0	V3RP5	V3RP4	V3RP3	V3RP2	V3RP1	V3RP0	0	0	V4RN5	V4RN4	V4RN3	V4RN2	V4RN1	V4RN0	
33h	$\gamma$ Control (4)	0	0	V4RP5	V4RP4	V4RP3	V4RP2	V4RP1	V4RP0	0	0	V3RN5	V3RN4	V3RN3	V3RN2	V3RN1	V3RN0	
34h	$\gamma$ Control (5)	0	0	V5RP5	V5RP4	V5RP3	V5RP2	V5RP1	V5RP0	0	0	V2RN5	V2RN4	V2RN3	V2RN2	V2RN1	V2RN0	
35h	$\gamma$ Control (6)	0	0	0	V6RP4	V6RP3	V6RP2	V6RP1	V6RP0	0	0	0	V1RN4	V1RN3	V1RN2	V1RN1	V1RN0	
36h	$\gamma$ Control (7)	0	0	0	V7RP4	V7RP3	V7RP2	V7RP1	V7RP0	0	0	0	V8RN4	V8RN3	V8RN2	V8RN1	V8RN0	
37h	$\gamma$ Control (8)	0	0	0	V8RP4	V8RP3	V8RP2	V8RP1	V8RP0	0	0	0	V7RN4	V7RN3	V7RN2	V7RN1	V7RN0	
38h	$\gamma$ Control (9)	0	0	0	V9RP3	V9RP2	V9RP1	V9RP0	0	0	0	0	V16RN3	V16RN2	V16RN1	V16RN0		
39h	$\gamma$ Control (10)	0	0	0	0	V10RP3	V10RP2	V10RP1	V10RP0	0	0	0	0	V15RN3	V15RN2	V15RN1	V15RN0	
3Ah	$\gamma$ Control (11)	0	0	0	0	V11RP3	V11RP2	V11RP1	V11RP0	0	0	0	0	V14RN3	V14RN2	V14RN1	V14RN0	
3Bh	$\gamma$ Control (12)	0	0	0	0	V12RP3	V12RP2	V12RP1	V12RP0	0	0	0	0	V13RN3	V13RN2	V13RN1	V13RN0	
3Ch	$\gamma$ Control (13)	0	0	0	0	V13RP3	V13RP2	V13RP1	V13RP0	0	0	0	0	V12RN3	V12RN2	V12RN1	V12RN0	
3Dh	$\gamma$ Control (14)	0	0	0	0	V14RP3	V14RP2	V14RP1	V14RP0	0	0	0	0	V11RN3	V11RN2	V11RN1	V11RN0	
3Eh	$\gamma$ Control (15)	0	0	0	0	V15RP3	V15RP2	V15RP1	V15RP0	0	0	0	0	V10RN3	V10RN2	V10RN1	V10RN0	
3Fh	$\gamma$ Control (16)	0	0	0	0	V16RP3	V16RP2	V16RP1	V16RP0	0	0	0	0	V9RN3	V9RN2	V9RN1	V9RN0	
50h	Window Horizontal RAM Address Start	0	0	0	0	0	0	0	0	HSA7 (0)	HSA6 (0)	HSA5 (0)	HSA4 (0)	HSA3 (0)	HSA2 (0)	HSA1 (0)	HSA0 (0)	
51h	Window Horizontal RAM Address End	0	0	0	0	0	0	0	0	HEA7 (1)	HEA6 (1)	HEA5 (1)	HEA4 (0)	HEA3 (1)	HEA2 (1)	HEA1 (1)	HEA0 (1)	
52h	Window Vertical RAM Address Start	0	0	0	0	0	0	0	VSA8 (0)	VSA7 (0)	VSA6 (0)	VSA5 (0)	VSA4 (0)	VSA3 (0)	VSA2 (0)	VSA1 (0)	VSA0 (0)	
53h	Window Vertical RAM Address End	0	0	0	0	0	0	0	VEA8 (1)	VEA7 (0)	VEA6 (0)	VEA5 (1)	VEA4 (1)	VEA3 (1)	VEA2 (1)	VEA1 (1)	VEA0 (1)	
60h	Driver Output Control	GS (0)	0	NL5 (0)	NL4 (0)	NL3 (0)	NL2 (0)	NL1 (0)	NL0 (0)	0	0	SCN5 (0)	SCN4 (0)	SCN3 (0)	SCN2 (0)	SCN1 (0)	SCN0 (0)	

61h	Driver Output Control	0	0	0	0	0	0	0	0	0	0	0	0	0	0	NDL (0)	VLE (0)	REV (0)
6Ah	Vertical Scroll Control	0	0	0	0	0	0	0	VL8 (0)	VL7 (0)	VL6 (0)	VL5 (0)	VL4 (0)	VL3 (0)	VL2 (0)	VL1 (0)	VL0 (0)	
80h	Display Position - Partial Display 1	0	0	0	0	0	0	0	PTDP08 (0)	PTDP07 (0)	PTDP06 (0)	PTDP05 (0)	PTDP04 (0)	PTDP03 (0)	PTDP02 (0)	PTDP01 (0)	PTDP00 (0)	
81h	RAM Address Start - Partial Display 1	0	0	0	0	0	0	0	PTSA08 (0)	PTSA07 (0)	PTSA06 (0)	PTSA05 (0)	PTSA04 (0)	PTSA03 (0)	PTSA02 (0)	PTSA01 (0)	PTSA00 (0)	
82h	RAM Address End - Partial Display 1	0	0	0	0	0	0	0	PTEA08 (0)	PTEA07 (0)	PTEA06 (0)	PTEA05 (0)	PTEA04 (0)	PTEA03 (0)	PTEA02 (0)	PTEA01 (0)	PTEA00 (0)	
83h	Display Position - Partial Display 2	0	0	0	0	0	0	0	PTDP18 (0)	PTDP17 (0)	PTDP16 (0)	PTDP15 (0)	PTDP14 (0)	PTDP13 (0)	PTDP12 (0)	PTDP11 (0)	PTDP10 (0)	
84h	RAM Address Start - Partial Display 2	0	0	0	0	0	0	0	PTSA18 (0)	PTSA17 (0)	PTSA16 (0)	PTSA15 (0)	PTSA14 (0)	PTSA13 (0)	PTSA12 (0)	PTSA11 (0)	PTSA10 (0)	
85h	RAM Address End - Partial Display 2	0	0	0	0	0	0	0	PTEA18 (0)	PTEA17 (0)	PTEA16 (0)	PTEA15 (0)	PTEA14 (0)	PTEA13 (0)	PTEA12 (0)	PTEA11 (0)	PTEA10 (0)	
90h	Panel interface Control 1	0	0	0	0	0	0	DIV11 (0)	DIV10 (0)	0	0	0	RTNI4 (1)	RTNI3 (0)	RTNI2 (0)	RTNI1 (0)	RTNI0 (0)	
92h	Panel Interface Control 2	0	0	0	0	0	NOWI2 (0)	NOWI1 (0)	NOWI0 (0)	0	0	0	0	0	0	0	0	
93h	Panel Interface Control 3	0	0	0	0	0	0	VEQW11 (0)	VEQW10 (0)	0	0	0	0	0	MCPI2 (0)	MCPI1 (0)	MCPI0 (0)	
95h	Panel Interface Control 4	0	0	0	0	0	0	DIVE1 (0)	DIVE0 (0)	0	0	RTNE5 (0)	RTNE4 (1)	RTNE3 (1)	RTNE2 (1)	RTNE1 (1)	RTNE0 (0)	
97h	Panel Interface Control 5	0	0	0	0	NOWE3 (0)	NOWE2 (0)	NOWE1 (0)	0	0	0	0	0	0	0	0	0	
98h	Panel Interface Control 6	0	0	0	0	0	0	0	0	0	0	0	0	0	MCPE2 (0)	MCPE1 (0)	MCPE0 (0)	
A4h	Calibration control	0	0	0	0	0	0	0	0	0	0	0	0	0	0	0	CALB (0)	

The following are detailed explanations of instructions with illustrations of instruction bits (CB15-0) assigned to each interface.

### 6.2.1. Index Register (IR)

R/W	RS	CB15	CCB14	CB13	CB12	CB11	CB10	CB9	CB8	CB7	CB6	CB5	CB4	CB3	CB2	CB1	CB0
W	0	*	*	*	*	*	*	*	*	ID7	ID6	ID5	ID4	ID3	ID2	ID1	ID0

The index register specifies the index (R00h ~ RFFh) of a control register. The index range is from "000\_0000" to "111\_1111" in binary format.

### 6.2.2. ID Read Register (SR)

R/W	RS	CB15	CB14	CB13	CB12	CB11	CB10	CB9	CB8	CB7	CB6	CB5	CB4	CB3	CB2	CB1	CB0
R	0	0	1	0	1	0	1	0	0	0	0	0	0	1	0	0	0

The IC code of SPFD5408B can be accessed by read operation. '5408H can be read out when read ID operation is executed.

### 6.2.3. Driver Output Control Register (R01h)

R/W	RS	CB15	CB14	CB13	CB12	CB11	CB10	CB9	CB8	CB7	CB6	CB5	CB4	CB3	CB2	CB1	CB0
W	1	0	0	0	0	0	SM	0	SS	0	0	0	0	0	0	0	0

**SS:** Shift direction of the source driver output selection.  
 When SS = "0", source driver shift from S1 to S720.  
 When SS = "1", source driver shift from S720 to S1.  
 Moreover, SS can cooperate with BGR for different color filter configuration of LCD panel. The combination of SS and BGR bit are summarized at **Table 6-2**.

**SM:** Set the scan mode of the gate driver output. Moreover, SM can cooperate with GS for different LCD panel gate line layout. The combination of GS and SM bit are summarized at **Table 6-3**.

**Table 6-2**

SS=0;BGR=0;	S1	S2	S3	.....▶	S718	S719	S720
SS=0;BGR=1;	S1	S2	S3	.....▶	S718	S719	S720
SS=1;BGR=0;	S1	S2	S3	.....◀	S718	S719	S720
SS=1;BGR=1;	S1	S2	S3	.....◀	S718	S719	S720

**Table 6-3**

SM	GS	Shift Direction (begin,.....end)
0	0	G1, G2, G3, G4.....G317, G318, G319, G320
0	1	G320, G319, G318, G317.....G4, G3, G2, G1
1	0	G1, G3, G5, ...G317, G319, ...G2, G4,... G318, G320
1	1	G320, G318, G316,..G4, G2, ..G319, G317,...G3, G1

### 6.2.4. LCD Driving Waveform Control (R02h)

R/W	RS	CB15	CB14	CB13	CB12	CB11	CB10	CB9	CB8	CB7	CB6	CB5	CB4	CB3	CB2	CB1	CB0
W	1	0	0	0	0	0	1	B/C	0	0	0	0	0	0	0	0	0

**B/C:** This bit is to set the Vcom toggle at frame rate format of N-line inversion format.

B/C=0: Frame inversion.

B/C=1: 1-line inversion.

### 6.2.5. Entry Mode (R03h)

R/W	RS	CB15	CB14	CB13	CB12	CB11	CB10	CB9	CB8	CB7	CB6	CB5	CB4	CB3	CB2	CB1	CB0
W	1	TRIR	DFM	0	BGR	0	0	0	0	ORG	0	I/D1	I/D0	AM	0	0	0
		EG															

**Table 6-4**

Operation mode	ORG	AM	I/D1	I/D0	Function
Mode 1	0	0	0	0	Replace horizontal data
Mode 2	0	1	0	1	Replace vertical data
Mode 3	1	0	1	0	Conditionally replace horizontal data
Mode 4	1	1	1	1	Conditionally replace vertical data

	I/D[1:0] = 00 Horizontal : decrement Vertical : decrement	I/D[1:0] = 01 Horizontal : increment Vertical : decrement	I/D[1:0] = 10 Horizontal : decrement Vertical : increment	I/D[1:0] = 11 Horizontal : increment Vertical : increment
AM = 0 Horizontal				
AM = 1 Vertical				

**AM:** To set the update direction when writing data to GRAM.

If AM=1, data will write in vertical direction.

If AM=0, data will write in horizontal direction.

Moreover, if a fixed window GRAM accessing is desired, the writing direction can be set by I/D1-0 and AM bits.

**I/D1-0:** To specify address counter increment /decrement automatically function while GRAM is accessing. I/D[0] indicates the increment or decrement in horizontal direction. I/D[1] indicates the increment or decrement in vertical direction.

I/D[0]=0: decrement in horizontal direction automatically

I/D[0]=1: increment in horizontal direction automatically

I/D[1]=0: decrement in vertical direction automatically

I/D[1]=1: increment in vertical direction automatically

I/D[1-0] setting can cooperate with Am bit to set the data updating direction.

**ORG:** SPFD5408B provides the option of start address definition when window function is selected.

ORG=0: RAM address setting (R20h, R21h) should set to the window start address, as normal operation case.

ORG=1: RAM address setting (R20h, R21h) should set to (00000h) no matter where the window start address is. In this case, the window start position is treated as (00000h), regardless the physical location in GRAM.

**BGR:** To set the order of RGB dot location in GRAM.

BGR=0: same assignment of RGB allocation of DB17-0

BGR=1: inverse assignment of RGB allocation of DB17-0

**DFM:** In combination with TRIREG setting, sets the format to develop 16-/8-bit data to 18-bit data when using either 16-bit or 8-bit bus interface. Make sure to set DFM=0 when not transferring data via 16-bit or 8-bit interface.

**TRIREG:** to set 1-3 time transfer mode for system interface. TRI bit should cooperate with DFM to meet the specific transfer mode.

For 8-bit data bus interface mode:

TRIREG=0: 2 time transfer mode for 16-bit GRAM data.

TRIREG=1: 3 time transfer mode for 18-bit GRAM data

For 16-bit data bus interface mode:

TRIREG=0: 1 time transfer mode for 16-bit GRAM data.

TRIREG=1: 2 time transfer mode for 18-bit GRAM data

Note: Set TRIREG=0, when using neither 8-bit nor 16-bit.

**6.2.6. Scaling Control register (R04h)**

R/W	RS	CB15	CB14	CB13	CB12	CB11	CB10	CB9	CB8	CB7	CB6	CB5	CB4	CB3	CB2	CB1	CB0
W	1	0	0	0	0	0	0	RCV1	RCV0	0	0	RCH1	RCH0	0	0	RSZ1	RSZ0

**RSZ [1:0]:** SPFD5408B provides scaling factor to give the display more flexibility to show different picture size. For detail, refer to “Scaling function”.

RSZ1	RSZ0	Scaling Factor
0	0	No Scaling
0	1	1/2 times
1	0	Setting Disable
1	1	1/4 times

**RCH [1:0]:** To set the surplus pixel number in horizontal direction when scaling mode is selected. When scaling mode is not selected, make sure RCH[1:0]= “00”

RCH1	RCH0	Surplus pixel number in Horizontal direction
0	0	0 Pixel
0	1	1 Pixel
1	0	2 Pixels
1	1	3 Pixels

**RCH [1:0]:** To set the surplus pixel number in Vertical direction when scaling mode is selected. When scaling mode is not selected, make sure RCV[1:0]= “00”

RCV1	RCV0	Surplus pixel number in Vertical direction
0	0	0 Pixel
0	1	1 Pixel
1	0	2 Pixels
1	1	3 Pixels

**6.2.7. Display Control (R07h)**

R/W	RS	CB15	CB14	CB13	CB12	CB11	CB10	CB9	CB8	CB7	CB6	CB5	CB4	CB3	CB2	CB1	CB0
W	1	0	0	PTDE	PTDEC	0	0	0	BASEE	0	0	0	DTE	COL	0	D1	0

**D1-0:** To set the internal operation, source driver output and VCOM output function. When D1-0=00; SPFD5408B is set to standby mode. The combination of D1 and AM bit is summarized at **Table 6-5**.

**Table 6-5**

D1	BASEE	Source, VCOM output	Internal Operation	FLM
0	*	GND	Terminated	OFF
1	0	Non-lit display	Normal Operation	ON
	1	Normal display	Normal Operation	ON

**COL:** 8-color mode selection. When CL=1 SPFD5408B enter to 8-color mode. When CL=0, SPFD5408B is in normal operation mode.

**DTE:** Specify the high/low level of gate driver output signal. The meaning of DTE bit is summarized at Table 6-6.

**Table 6-6**

APE	DTE	Gate Output
1	0	VGL
	1	VGH/VGL



**BASEE:** To enable Base image display

BASEE	
0	(1) Non-lit display (2) Partial image display
1	Base image is display on the LCD

PTDE [0]: "0" Partial image 1 display "Off".

"1" Partial image 1 display "On".

PTDE [1]: "0" Partial image 2 display "Off".

"1" Partial image 2 display "On".

**PTDE1-0:** To set the partial-display enables function.

### 6.2.8. Display Control 2 (R08h)

R/W	RS	CB15	CB14	CB13	CB12	CB11	CB10	CB9	CB8	CB7	CB6	CB5	CB4	CB3	CB2	CB1	CB0
W	1	0	0	0	0	FP3	FP2	FP1	FP0	0	0	0	0	BP3	BP2	BP1	BP0

**FP3-0:** Set the amount of blank period of front porch

**BP3-0:** Set the amount of blank period of back porch

**Table 6-7** summarized the function of FP3-0/BP3-0 setting.

When setting this register, make sure that:

$BP + FP \leq 16$  lines

$FP \geq 2$  lines

$BP \geq 2$  lines

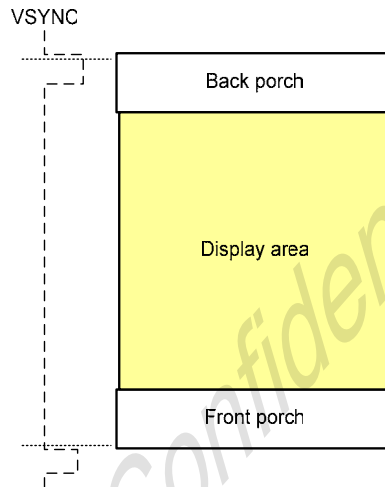
In external display interface mode, a back porch (BP) period starts on the falling edge of the VSYNC signal, followed by a display operation period. After driving the number of lines set with NL bits, a front porch period starts. After the front porch period, a blank period continues until the next input of VSYNC signal. Be aware that different interface mode, has different BP/ FP setting. **Table 6-8** summarized the setting for each interface mode.

**Table 6-7**

FP3	FP2	FP1	FP0	Number of lines for the Front Porch
BP3	BP2	BP1	BP0	Number of lines for the Back Porch
0	0	0	0	Setting disabled
0	0	0	1	Setting disabled
0	0	1	0	2 lines
0	0	1	1	3 lines
0	1	0	0	4 lines
0	1	0	1	5 lines
0	1	1	0	6 lines
0	1	1	1	7 lines
1	0	0	0	8 lines
1	0	0	1	9 lines
1	0	1	0	10 lines
1	0	1	1	11 lines
1	1	0	0	12 lines
1	1	0	1	13 lines
1	1	1	0	14 lines
1	1	1	1	Setting disabled

**Table 6-8**

Operation of Internal clock	$BP \geq 2$ lines	$FP \geq 2$ lines	$FP + BP \leq 16$ lines
RGB interface	$BP \geq 2$ lines	$FP \geq 2$ lines	$FP + BP \leq 16$ lines
VSYNC interface	$BP \geq 2$ lines	$FP \geq 2$ lines	$FP + BP = 16$ lines


**Figure 6-7** Front porch and back porch function diagram

**6.2.9. Display Control 3 (R09h)**

R/W	RS	CB15	CB14	CB13	CB12	CB11	CB10	CB9	CB8	CB7	CB6	CB5	CB4	CB3	CB2	CB1	CB0
W	1	0	0	0	0	0	PTS2	PTS1	PTS0	0	0	PTG1	PTG0	ISC3	ISC2	ISC1	ISC0

**ISC3-0:** To set the gate driver scan cycle in non-display area.

**Table 6-9** summarized the function of ISC3-0 setting

**Table 6-9**

ISC3	ISC2	ISC1	ISC0	Scan cycle	fFLM=60Hz
0	0	0	1	Setting disable	
0	0	1	0	3 frames	50 ms
0	0	1	1	5 frames	84 ms
0	1	0	0	7 frames	117 ms
0	1	0	1	9 frames	150 ms
0	1	1	0	11 frames	184 ms
0	1	1	1	13 frames	217 ms
1	0	0	0	15 frames	251 ms
1	0	0	1	19 frames	317 ms
1	0	1	0	21 frames	351 ms
1	0	1	1	23 frames	384 ms
1	1	0	0	25 frames	418 ms
1	1	0	1	27 frames	451 ms
1	1	1	0	29 frames	484 ms
1	1	1	1	31 frames	518 ms

**PTG1-0:** To set the gate driver scan mode in non-display area.

**Table 6-10** summarized the function of PTG1-0 setting

**Table 6-10**

PTG1	PTG0	Gate outputs in non-display area	Source outputs in non-display area	VCOM output
0	0	Normal scan	Based on the PTS2-0 bits setting	VCOMH/VCOML
0	1	Setting Disable		
1	0	Interval scan	Based on the PTS2-0 bits setting	VCOMH/VCOML
1	1	Setting Disable		

**PTS2-0:** To set the source driver output level in non-display area of partial display mode. **Table 6-11** summarized the function of PTS2-0 setting.

**Table 6-11**

PTS2	PTS1	PTS0	Source output in non-display area		Operation amplifier in non-display area
			+ polarity	- polarity	
0	0	0	V63	V0	V0-V63
0	0	1	Invalid setting	Invalid setting	-
0	1	0	GND	GND	V0-V63
0	1	1	High impedance	High impedance	V0-V63
1	0	0	V63	V0	V0, V63
1	0	1	Invalid setting	Invalid setting	-
1	1	0	GND	GND	V0, V63
1	1	1	High impedance	High impedance	V0, V63

### 6.2.10. Frame Cycle Control (R0Ah)

R/W	RS	CB15	CB14	CB13	CB12	CB11	CB10	CB9	CB8	CB7	CB6	CB5	CB4	CB3	CB2	CB1	CB0
W	1	0	0	0	0	0	0	0	0	0	0	0	0	FMARK KOE	FMI2	FMI1	FMI0

**FMI [2:0]:** SPFD5408 provide FMARK signal to prevent tearing effect. FMI [2:0] can set FMARK output interval.

FMI2	FMI1	FMI0	Output interval
0	0	0	1 frame
0	0	1	2 frames
0	1	1	4 frames
1	0	1	6 frames
Other Setting			Setting Disable

**FMARKOE:** Initialized the output signal FMARK from FMARK pin.

FMARK="0": Output FMARK disable

FMARK="1": Output FMARK enables.

**6.2.11. External Display Interface Control 1 (R0Ch)**

R/W	RS	CB15	CB14	CB13	CB12	CB11	CB10	CB9	CB8	CB7	CB6	CB5	CB4	CB3	CB2	CB1	CB0
W	1	0	0	0	0	0	0	0	RM	0	0	DM1	DM0	0	0	RIM1	RIM0

**RIM1-0:** To set the different transfer modes of RGB interface.

**Table 6-12** summarized the function of RIM1-0 setting.

**Table 6-12**

RIM1	RIM0	RGB Interface Mode	Colors	Data Bus
0	0	18-bit RGB interface (one transfer/pixel)	262K	DB 17-0
0	1	16-bit RGB interface (one transfer/pixel)	65K	DB 17-13; DB 11-1
1	0	6-bit RGB interface (three transfers/pixel)	262K	DB17-12
1	1	Setting disabled	-	-

**DM1-0:** To specify the display interface mode. DM1-0 Setting can switch the display interface among system interface, RGB interface and VSYNC interface.

**Table 6-13** summarized the function of DM1-0 setting.

DM1	DM0	Display Interface
0	0	Internal clock operation
0	1	RGB interface
1	0	VSYNC interface
1	1	Setting disabled

**Table 6-13**

**RM:** Select the interface to access the SPFD5408B's internal GRAM. Set RM to "1" when writing display data via the RGB interface. The SPFD5408B allows for setting the RM bit not constrained by the mode used for the display operation. This means it is possible to rewrite display data via a system interface by setting RM = "0" even while display operations are performed via the RGB interface.

**Table 6-14** summarized the function of RM bit setting.

**Table 6-14**

RM	Interface for RAM Access
0	System interface/VSYNC interface
1	RGB interface

**Table 6-15**

Display State	Operation Mode	RAM Access (RM)	Display Operation Mode (DM1-0)
Still pictures	Internal clock operation	System interface (RM = 0)	Internal clock operation (DM1-0 = 00)
Moving pictures	RGB interface (1)	RGB interface (RM = 1)	RGB interface (DM1-0 = 01)
Rewrite still picture area while displaying moving pictures.	RGB interface (2)	System interface (RM = 0)	RGB interface (DM1-0 = 01)
Moving pictures	VSYNC interface	System interface (RM = 0)	VSYNC interface (DM1-0 = 10)

**Note1:** Instructions are set only via the system interface.

**Note2:** The RGB-I/F and the VSYNC-I/F are not used simultaneously.

**Note3:** Do not make changes to the RGB-I/F mode setting (RIM-0) while the RGB I/F is in operation.

**Note4:** See the "External Display Interface" section for the flowcharts to follow when switching from one mode to another.

### 6.2.12. Frame Maker Position (R0Dh)

R/W	RS	CB15	CB14	CB13	CB12	CB11	CB10	CB9	CB8	CB7	CB6	CB5	CB4	CB3	CB2	CB1	CB0
W	1	0	0	0	0	0	0	0	FMP8	FMP7	FMP6	FMP5	FMP4	FMP3	FMP2	FMP1	FMP0

**FMP 8-0:** indicates the output position of frame cycle signal (frame maker) relation with back porch. When FMP[8:0] = 9'h000, FMARK is outputted at the start of back porch. When FMP[8:0] = 9'h001, FMARK is outputted one line after the start of back porch.

FMP [8:0]	RAM data write cycle
9'h000	immediate
9'h001	1 line
9'h002	2 line
	~
9'h175	373 lines
9'h176	374 lines
9'h177	375 lines

### 6.2.13. External Display Interface Control 2 (R0Fh)

R/W	RS	CB15	CB14	CB13	CB12	CB11	CB10	CB9	CB8	CB7	CB6	CB5	CB4	CB3	CB2	CB1	CB0
W	1	0	0	0	0	0	0	0	0	0	0	0	VSPL	HSPL	0	EPL	DPL

**EPL:** The polarity of ENABLE signal selection in RGB interface mode.

EPL = "0": ENABLE: Low active

EPL = "1": ENABLE: High active

**VSPL:** The polarity of VSYNC signal selection in RGB interface mode.

VSPL = "0": Low active.

VSPL = "1": High active.

**DPL:** Select the data latch edge of the DOTCLK signal in RGB interface mode.

DPL = "0": rising edge of the DOTCLK.

DPL = "1": falling edge of the DOTCLK.

**HSPL:** The polarity of HSYNC signal selection in RGB interface mode.

HSPL = "0": Low active.

HSPL = "1": High active.

### 6.2.14. Power Control 1 (R10h)

R/W	RS	CB15	CB14	CB13	CB12	CB11	CB10	CB9	CB8	CB7	CB6	CB5	CB4	CB3	CB2	CB1	CB0
W	1	0	0	0	SAP	0	BT2	BT1	BT0	APE	0	AP1	AP0	0	DSTB	SLP	0

**SLP:** Sleep mode selection. When SLP =1, SPFD5408B set to sleep mode. In sleep mode, all internal operations are terminated except internal RC oscillation. Be sure that a display off sequence should be executed before set SLP to "1". In sleep mode, no instruction can be accepted except R11h, R13h, bit 3-0 of R12h and R10h (except SAP2-0). Set STB=0 can exit sleep mode. Moreover, when exit from sleep mode, data in GRAM and in instruction registers are keep the same with these before set to SLP mode.

**DSTB:** Deep Standby mode selection. When DSTB =1, SPFD5408B set to deep standby mode. In this mode, all internal operations are terminated including internal RC oscillation. Be sure that a display off sequence should be executed before set DSTB to "1". Set DSTB=0 can exit standby mode. Be sure that start oscillation following by 10ms delay should be executed before set DSTB to "0". Moreover, when exit from deep standby mode, data in GRAM and register might be lost, reset and re-sending command and data into GRAM is necessary.

**BT3-0:** Set the voltage level of DDVDH, VGH, VGL and VCL.

**Table 6-17** summarized the function of BT3-0 setting

BT2	BT1	BT0	DDVDH	VGH	VGL	VCL	Capacitor connection pins
0	0	0	VCI1 x 2 [x2]	DDVDH x 3 [VCI1 x 6]	-(VCI1+DDVDHx 2) [VCI1x -5]	-VCI1	C23 can be eliminated
0	0	1	VCI1 x 2 [x2]	DDVDH x 3 [VCI1 x 6]	-(DDVDHx 2) [VCI1x -4]	-VCI1	
0	1	0	VCI1 x 2 [x2]	DDVDH x 3 [VCI1 x 6]	-(VCI1+DDVDH) [VCI1x -3]	-VCI1	
0	1	1	VCI1 x 2 [x2]	DDVDH x 2 + VCI1 [VCI1 x 5]	-(VCI1+DDVDHx 2) [VCI1x -5]	-VCI1	
1	0	0	VCI1 x 2 [x2]	DDVDH x 2 + VCI1 [VCI1 x 5]	-(DDVDHx 2) [VCI1x -4]	-VCI1	
1	0	1	VCI1 x 2 [x2]	DDVDH x 2 + VCI1 [VCI1 x 5]	-(VCI1+DDVDH) [VCI1x -3]	-VCI1	
1	1	0	VCI1 x 2 [x2]	DDVDH x 2 [VCI1 x 4]	-(DDVDHx 2) [VCI1x -4]	-VCI1	C23 can be eliminated
1	1	1	VCI1 x 2 [x2]	DDVDH x 2 [VCI1 x 4]	-(VCI1+DDVDH) [VCI1x -3]	-VCI1	C23 can be eliminated

**SAP:** Enable bit for gamma voltage generation circuit.

SAP="0", Halt gamma voltage generation circuit.

SAP="1", Enable gamma voltage generation circuit

**AP1-0:** Operational amplifier DC bias current adjustment. Set AP1-0 = "00" to stop operational amplifier and DC/DC charge pump circuits to reduce current consumption during no display period. **Table 6-16** summarized the function of AP1-0 setting

**Table 6-16**

AP1	AP0	Constant current in power supply circuit	Constant current in Gamma circuit
0	0	Halt	Halt
0	1	0.5	0.62
1	0	0.75	0.71
1	1	1	1

**APE:** Enable bit for both liquid crystal power supply and gamma voltage generation circuit.

APE="0", Halt liquid crystal power supply and gamma voltage generation circuit

APE="1", Enable liquid crystal power supply and gamma voltage generation circuit.

**6.2.15. Power Control 2 (R11h)**

R/W	RS	CB15	CB14	CB13	CB12	CB11	CB10	CB9	CB8	CB7	CB6	CB5	CB4	CB3	CB2	CB1	CB0
W	1	0	0	0	0	0	DC12	DC11	DC10	0	DC02	DC01	DC00	0	VC2	VC1	VC0

**VC2-0:** Set the voltage of VCIOUT. VCIOUT is generated by VCI.

**Table 6-18** summarized the function of VC2-0 setting

**Table 6-18**

VC2	VC1	VC0	VCIOUT
0	0	0	0.94 x VCI
0	0	1	0.89 x VCI
0	1	0	Setting Disable
0	1	1	Setting Disable
1	0	0	0.76 x VCI
1	0	1	Setting Disable
1	1	0	Setting Disable
1	1	1	1.00 x VCI

**DC02-00:** Set DC/DC charge pump circuit 1 operating frequency.

**Table 6-19** summarized the function of DC02-00 setting

**Table 6-19**

DC02	DC01	DC00	DC/DC charge pump circuit 1 frequency (fDCDC1)
0	0	0	Oscillation clock
0	0	1	Oscillation clock / 2
0	1	0	Oscillation clock / 4
0	1	1	Oscillation clock / 8
1	0	0	Oscillation clock / 16
1	0	1	Invalid Setting
1	1	0	Halt Step-up Circuit 1
1	1	1	Invalid Setting

**Table 6-20** summarized the function of DC02-00 setting

**Note:** Be aware that DC/DC charge pump 1 frequency  $\geq$  DC/DC charge pump 2 frequency

**Table 6-20**

DC12	DC11	DC10	Step-up circuit 2 step-up frequency (fDCDC2)
0	0	0	Oscillation clock / 16
0	0	1	Oscillation clock / 32
0	1	0	Oscillation clock / 64
0	1	1	Oscillation clock / 128
1	0	0	Oscillation clock / 256
1	0	1	Setting disabled
1	1	0	Halt Step-up Circuit 2
1	1	1	Setting disabled

**Note:** Be sure  $f_{DCDC1} \geq f_{DCDC2}$  when setting DC02-00, DC12-10.

**DC12-10:** Set DC/DC charge pump circuit 2 operating frequency.

**6.2.16. Power Control 3 (R12h)**

R/W	RS	CB15	CB14	CB13	CB12	CB11	CB10	CB9	CB8	CB7	CB6	CB5	CB4	CB3	CB2	CB1	CB0
W	1	0	0	0	0	0	0	0	1	VREG1R	0	0	0	VRH3	VRH2	VRH1	VRH0

**VRH3-0:** Set the voltage level of VCI. VCI is generated by VREG1OUT. **Table 6-21** summarized the function of VRH3-0 setting

**Table 6-21**

VRH3	VRH2	VRH1	VRH0	VREG1OUT voltage		VRH3	VRH2	VRH1	VRH0	VREG1OUT voltage	
				VCI	VCIR					VCI	VCIR
0	0	0	0	Halt	Halt	1	0	0	0	VCIx1.6	2.5Vx1.6
0	0	0	1	Halt	Halt	1	0	0	1	VCIx1.65	2.5Vx1.65
0	0	1	0	Halt	Halt	1	0	1	0	VCIx1.7	2.5Vx1.7
0	0	1	1	Halt	Halt	1	0	1	1	VCIx1.75	2.5Vx1.75
0	1	0	0	Setting disable	Setting disable	1	1	0	0	VCIx1.8	2.5Vx1.8
0	1	0	1	Setting disable	Setting disable	1	1	0	1	VCIx1.85	2.5Vx1.85
0	1	1	0	Setting disable	Setting disable	1	1	1	0	VCIx1.9	2.5Vx1.9
0	1	1	1	Setting disable	Setting disable	1	1	1	1	Setting disable	Setting disable

**VREG1R:** Select reference voltage for VREG1OUT

VREG1R = "0" (default): VCI (External) as reference voltage for VREG1OUT.

VREG1R = "1": VCIR (internal) as reference voltage for VREG1OUT.



**6.2.17. Power Control 4 (R13h)**

R/W	RS	CB15	CB14	CB13	CB12	CB11	CB10	CB9	CB8	CB7	CB6	CB5	CB4	CB3	CB2	CB1	CB0
W	1	0	0	0	VDV4	VDV3	VDV2	VDV1	VDV0	0	0	0	0	0	0	0	0

**VDV4-0:** Set the Vcom amplitude. Vcom amplitude is generated by VREG1OUT.

**Table 6-22**

VDV4	VDV3	VDV2	VDV1	VDV0	Vcom amplitude
0	0	0	0	0	VREG1OUT x 0.70
0	0	0	0	1	VREG1OUT x 0.72
0	0	0	1	0	VREG1OUT x 0.74
0	0	0	1	1	VREG1OUT x 0.76
0	0	1	0	0	VREG1OUT x 0.78
0	0	1	0	1	VREG1OUT x 0.80
0	0	1	1	0	VREG1OUT x 0.82
0	0	1	1	1	VREG1OUT x 0.84
0	1	0	0	0	VREG1OUT x 0.86
0	1	0	0	1	VREG1OUT x 0.88
0	1	0	1	0	VREG1OUT x 0.90
0	1	0	1	1	VREG1OUT x 0.92
0	1	1	0	0	VREG1OUT x 0.94
0	1	1	0	1	VREG1OUT x 0.96
0	1	1	1	0	VREG1OUT x 0.98
0	1	1	1	1	VREG1OUT x 1.00
1	0	0	0	0	VREG1OUT x 1.02
1	0	0	0	1	VREG1OUT x 1.04
1	0	0	1	0	VREG1OUT x 1.06
1	0	0	1	1	VREG1OUT x 1.08
1	0	1	0	0	VREG1OUT x 1.10
1	0	1	0	1	VREG1OUT x 1.12
1	0	1	1	0	VREG1OUT x 1.14
1	0	1	1	1	VREG1OUT x 1.16
1	1	0	0	0	VREG1OUT x 1.18
1	1	0	0	1	VREG1OUT x 1.20
1	1	0	1	0	VREG1OUT x 1.22
1	1	0	1	1	VREG1OUT x 1.24
1	1	1	0	0	Setting disable
1	1	1	0	1	Setting disable
1	1	1	1	0	Setting disable
1	1	1	1	1	Setting disable

**6.2.18. GRAM Address Set (Horizontal Address) (R20h)**

R/W	RS	CB15	CB14	CB13	CB12	CB11	CB10	CB9	CB8	CB7	CB6	CB5	CB4	CB3	CB2	CB1	CB0
W	1	0	0	0	0	0	0	0	0	AD7	AD6	AD5	AD4	AD3	AD2	AD1	AD0

**6.2.19. GRAM Address Set (Vertical Address) (R21h)**

R/W	RS	CB15	CB14	CB13	CB12	CB11	CB10	CB9	CB8	CB7	CB6	CB5	CB4	CB3	CB2	CB1	CB0
W	1	0	0	0	0	0	0	0	AD16	AD15	AD14	AD13	AD12	AD11	AD10	AD9	AD8

**AD16–0:** To set the initial address counter for GRAM address.

Based on AM and I/D[1:0] setting, the address counter is automatically increment or decrement while data are written to the internal GRAM. There is no need to update AD16-0 every data transfer if AD16-0 was set in the beginning of one frame graphic data. Be aware that address counter is not automatically updated if reading data from the internal GRAM instruction is executed. Moreover, the address counter cannot be accessed when the SPFD5408B is in standby mode.

Table 6-23 Table 6-23 summarized the function of AD15-0 setting

**Table 6-23**

AD16–AD0	GRAM Setting
"00000"H – "000EF"H	Bitmap data for G1
"00100"H – "001EF"H	Bitmap data for G2
"00200"H – "002EF"H	Bitmap data for G3
"00300"H – "003EF"H	Bitmap data for G4
:	:
"13600"H – "13CEF"H	Bitmap data for G317
"13700"H – "13DEF"H	Bitmap data for G318
"13800"H – "13EEF"H	Bitmap data for G319
"13900"H – "13FEF"H	Bitmap data for G320

**Note1:** The address AD16-0 should be set in the address counter every frame on the falling edge of VSYNC if RGB interface mode is selected.

**Note2:** The address AD16-0 should be set when executing an instruction if system or VSYNC interface mode is selected.

### 6.2.20. Write Data to GRAM (R22h)

R/W	RS	CB15	CB14	CB13	CB12	CB11	CB10	CB9	CB8	CB7	CB6	CB5	CB4	CB3	CB2	CB1	CB0
W	1	RAM write data (WD17-0) The DB17-0 pin assignment is different in different interface modes.															

**WD17-0:** SPFD5408B supports 18 bits data format. However, if only 16-bit (565format) is input to GRAM, SPFD5408B will expand the 16 bit data into 18-bit format. Same case when RGB interface is selected. Based on the graphic data in GRAM, the grayscale voltage of source driver is selected. **Table 6-24** summarized the source driver grayscale voltage output versus graphic data in GRAM.

**Figure 6-8 ~ Figure 6-18** illustrates the pin assignment among data bus (DB17-0), R22 (WD17-0) and GRAM.

**Table 6-24**

Data in GRAM RGB	Source Driver Grayscale Output	
	Negative	Positive
000000	V0	V63
000001	V1	V62
000010	V2	V61
000011	V3	V60
000100	V4	V59
000101	V5	V58
000110	V6	V57
000111	V7	V56
001000	V8	V55
001001	V9	V54
001010	V10	V53
001011	V11	V52
001100	V12	V51
001101	V13	V50
001110	V14	V49
001111	V15	V48
010000	V16	V47
010001	V17	V46
010010	V18	V45
010011	V19	V44
010100	V20	V43
010101	V21	V42
010110	V22	V41
010111	V23	V40
011000	V24	V39
011001	V25	V38
011010	V26	V37
011011	V27	V36
011100	V28	V35

Data in GRAM RGB	Source Driver Grayscale Output	
	Negative	Positive
011101	V29	V34
011110	V30	V33
011111	V31	V32
100000	V32	V31
100001	V33	V30
100010	V34	V29
100011	V35	V28
100100	V36	V27
100101	V37	V26
100110	V38	V25
100111	V39	V24
101000	V40	V23
101001	V41	V22
101010	V42	V21
101011	V43	V20
101100	V44	V19
101101	V45	V18
101110	V46	V17
101111	V47	V16
110000	V48	V15
110001	V49	V14
110010	V50	V13
110011	V51	V12
110100	V52	V11
110101	V53	V10
110110	V54	V9
110111	V55	V8
111000	V56	V7
111001	V57	V6
111010	V58	V5
111011	V59	V4
111100	V60	V3
111101	V61	V2
111110	V62	V1
111111	V63	V0

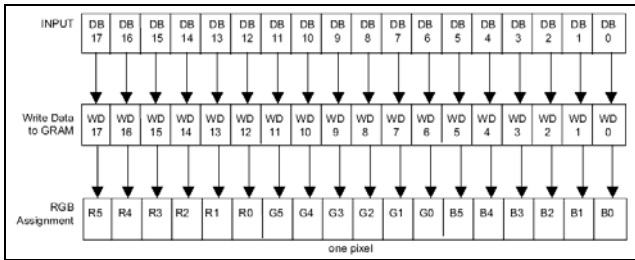


Figure 6-8 18-bit interface (262,144 colors) TRIREG = x1, DFM=x.

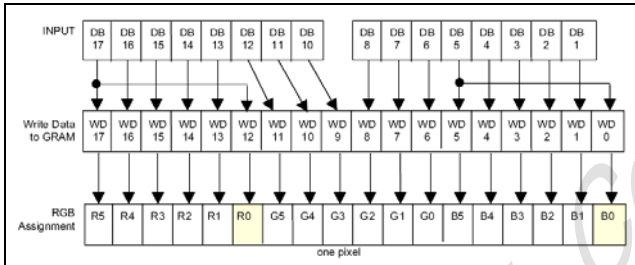


Figure 6-9 16-bit interface (65,536 colors) TRIREG=0, DFM=x

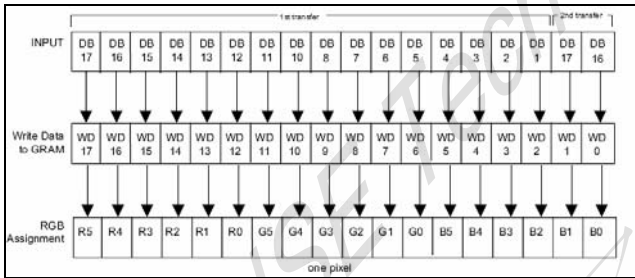


Figure 6-10 16-bit interface (262,144 colors) TRIREG = 1, DFM = 0

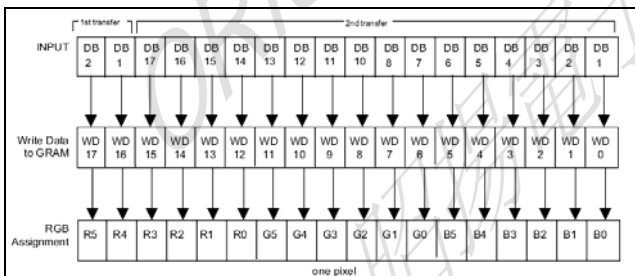


Figure 6-11 16-bit interface (262,144 colors) TRIREG = 1, DFM = 1

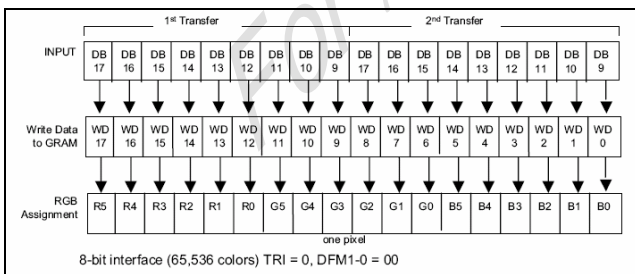


Figure 6-12 9-bit interface (262,144 colors) TRIREG=0, DFM=x

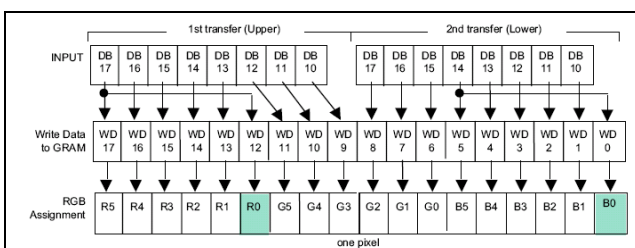


Figure 6-13 8-bit interface (65,536 colors) TRIREG = 0, DFM=x

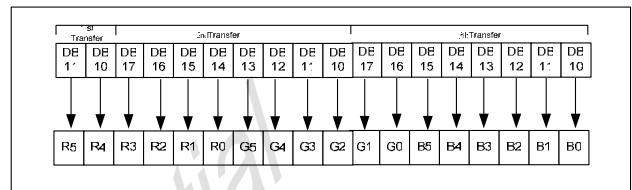


Figure 6-14 8-bit interface 262 colors TRIREG = 1, DFM=0.

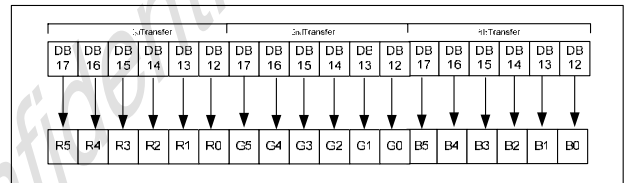


Figure 6-15 8-bit interface (262K colors) TRIREG = 1, DFM=1

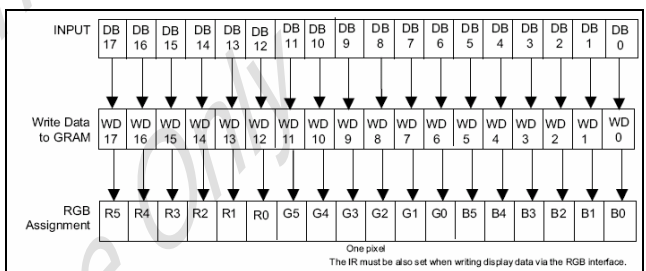


Figure 6-16 18-bit RGB interface (262,144 colors)

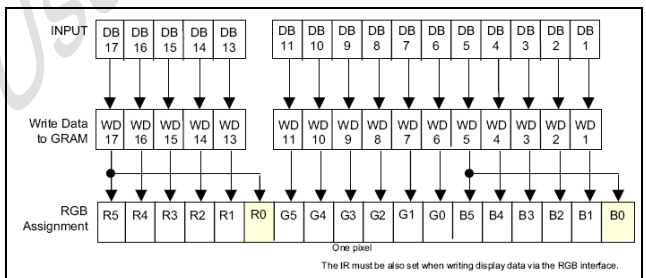


Figure 6-17 16-bit RGB interface (65,563 colors)

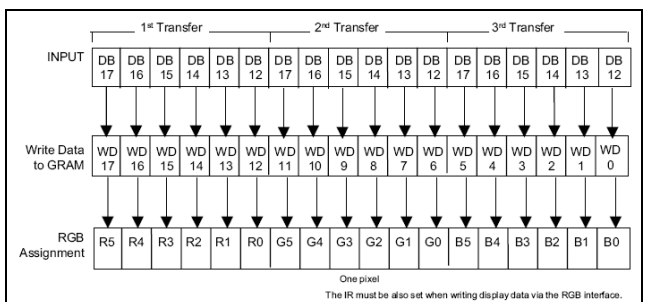


Figure 6-18 6-bit RGB interface (262,144 colors)

SPFD5408B supports external (RGB) interface. In RGB interface mode, all graphic data are stored in GRAM. To meet the diverse requirement of small size LCD panel, SPFD5408B also supports in a fix window using RGB interface and outside the window still use system interface.

In RGB interface mode, data writing to the internal RAM is synchronized with DOTCLK during ENABLE = "Low". Set ENABLE "High" to terminate writing data to RAM. Wait for a write/read bus cycle time. If accessing internal RAM using the RGB interface is desired after accessing the RAM via the system interface. **Figure 6-19** illustrates the timing diagram while RGB and system interface are both use in the same time.

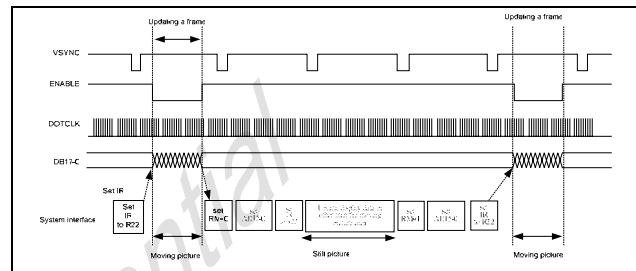


Figure 6-19

### 6.2.21. Read Data Read from GRAM (R22h)

R/W	RS	CB15	CB14	CB13	CB12	CB11	CB10	CB9	CB8	CB7	CB6	CB5	CB4	CB3	CB2	CB1	CB0
R	1	RAM Read data (RD17-0) The DB17-0 pin assignment is different in different interface modes.															

R22 also served as a register, which store the data read out from GRAM. When data are read out from the GRAM is desired, first sets the RAM address and executes first word read, and issues second word read. When first word read instruction is issued, Invalid data are sent to the data bus DB17-0. Valid data are sent to the data bus as second word data is executed.

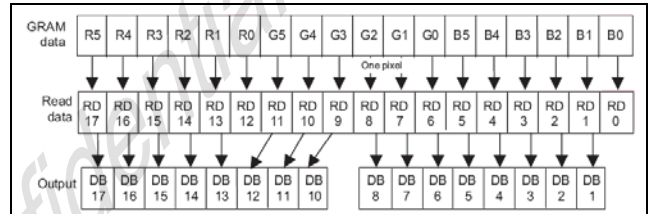


Figure 6-21 16-bit interface

The LSBs of R and B dots cannot read out, when the 8 or 16-bit interface is selected,

**Note:** This register is not available with the RGB interface. **Figure 6-20 ~ Figure 6-23** illustrates the pin assignment among data bus (DB17-0), R22 (RD17-0) and GRAM in read data instruction.

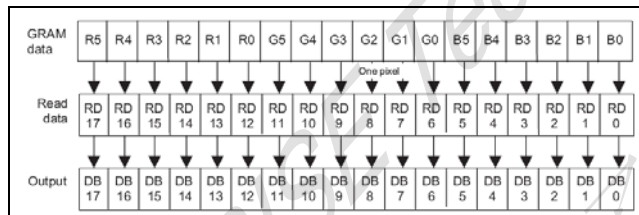


Figure 6-20 18-bit interface

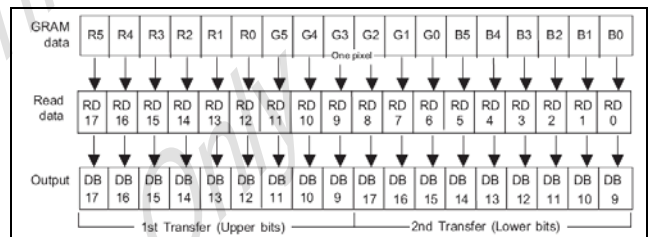


Figure 6-22 9-bit interface

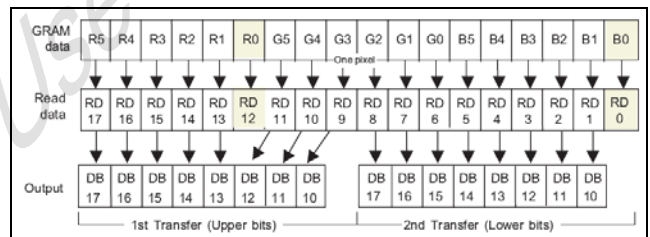


Figure 6-23 8-bit interface / SPI

### 6.2.22. NVM read data 1 (R28h)

R/W	RS	CB15	CB14	CB13	CB12	CB11	CB10	CB9	CB8	CB7	CB6	CB5	CB4	CB3	CB2	CB1	CB0
W	1	0	0	0	0	0	0	0	0	0	0	0	0	UID3	UID2	UID1	UID0

### 6.2.23. NVM read data 2 (R29h)

R/W	RS	CB15	CB14	CB13	CB12	CB11	CB10	CB9	CB8	CB7	CB6	CB5	CB4	CB3	CB2	CB1	CB0
W	1	0	0	0	0	0	0	0	0	0	0	0	VCM 14	VCM 13	VCM 12	VCM 11	VCM 10

**6.2.24. NVM read data 3 (R2Ah)**

R/W	RS	CB15	CB14	CB13	CB12	CB11	CB10	CB9	CB8	CB7	CB6	CB5	CB4	CB3	CB2	CB1	CB0
W	1	0	0	0	0	0	0	0	0	VCM SEL	0	0	VCM 24	VCM 23	VCM 22	VCM 21	VCM 20

**UID[3:0]:** SPFD5408B provides a 4-bit identification code UID[3:0] for user to use. UID[3:0] can be write / read from NVM. UID can be read out via R28h when CALB(RA4h, CB0) is set to 1.

**VCM1 [4:0]:** These pins are to set the factor for generating VCOMH when VCMSEL="0". **Table 6-25** summarized the factor of VREG1OUT

**Table 6-25**

VCM1[4:0]	VCOMH voltage
5'h00	VREG1OUT x 0.69
5'h01	VREG1OUT x 0.70
5'h02	VREG1OUT x 0.71
5'h03	VREG1OUT x 0.72
5'h04	VREG1OUT x 0.73
5'h05	VREG1OUT x 0.74
5'h06	VREG1OUT x 0.75
5'h07	VREG1OUT x 0.76
5'h08	VREG1OUT x 0.77
5'h09	VREG1OUT x 0.78
5'h0A	VREG1OUT x 0.79
5'h0B	VREG1OUT x 0.80
5'h0C	VREG1OUT x 0.81
5'h0D	VREG1OUT x 0.82
5'h0E	VREG1OUT x 0.83
5'h0F	VREG1OUT x 0.84
5'h10	VREG1OUT x 0.85
5'h11	VREG1OUT x 0.86
5'h12	VREG1OUT x 0.87
5'h13	VREG1OUT x 0.88
5'h14	VREG1OUT x 0.89
5'h15	VREG1OUT x 0.90
5'h16	VREG1OUT x 0.91
5'h17	VREG1OUT x 0.92
5'h18	VREG1OUT x 0.93
5'h19	VREG1OUT x 0.94
5'h1A	VREG1OUT x 0.95
5'h1B	VREG1OUT x 0.96
5'h1C	VREG1OUT x 0.97
5'h1D	VREG1OUT x 0.98
5'h1E	VREG1OUT x 0.99
5'h1F	VREG1OUT x 1.00

**VCM2 [4:0]:** These pins are to set the factor for generating VCOMH when VCMSEL="1". **Table 6-26** summarized the factor of VREG1OUT

**Table 6-26**

VCM2[4:0]	VCOMH voltage
5'h00	VREG1OUT x 0.69
5'h01	VREG1OUT x 0.70
5'h02	VREG1OUT x 0.71
5'h03	VREG1OUT x 0.72
5'h04	VREG1OUT x 0.73
5'h05	VREG1OUT x 0.74
5'h06	VREG1OUT x 0.75
5'h07	VREG1OUT x 0.76
5'h08	VREG1OUT x 0.77
5'h09	VREG1OUT x 0.78
5'h0A	VREG1OUT x 0.79
5'h0B	VREG1OUT x 0.80
5'h0C	VREG1OUT x 0.81
5'h0D	VREG1OUT x 0.82
5'h0E	VREG1OUT x 0.83
5'h0F	VREG1OUT x 0.84
5'h10	VREG1OUT x 0.85
5'h11	VREG1OUT x 0.86
5'h12	VREG1OUT x 0.87
5'h13	VREG1OUT x 0.88
5'h14	VREG1OUT x 0.89
5'h15	VREG1OUT x 0.90
5'h16	VREG1OUT x 0.91
5'h17	VREG1OUT x 0.92
5'h18	VREG1OUT x 0.93
5'h19	VREG1OUT x 0.94
5'h1A	VREG1OUT x 0.95
5'h1B	VREG1OUT x 0.96
5'h1C	VREG1OUT x 0.97
5'h1D	VREG1OUT x 0.98
5'h1E	VREG1OUT x 0.99
5'h1F	VREG1OUT x 1.00

VCMSEL: VCMSEL is to select VCM1 or VCM2; When VCMSEL="0", VCM1 is selected while VCMSEL="1", VCM2 is selected.

**6.2.25.  $\gamma$  Control (R30h to R3Fh)**
**Table 6-27**

	R/W	RS	CB15	CB14	CB13	CB12	CB11	CB10	CB9	CB8	CB7	CB6	CB5	CB4	CB3	CB2	CB1	CB0
R30	W	1	0	0	0	V1RP4	V1RP3	V1RP2	V1RP1	V1RP0	0	0	0	V6RN4	V6RN3	V6RN2	V6RN1	V6RN0
R31	W	1	0	0	V2RP5	V2RP4	V2RP3	V2RP2	V2RP1	V2RP0	0	0	V5RN5	V5RN4	V5RN3	V5RN2	V5RN1	V5RN0
R32	W	1	0	0	V3RP5	V3RP4	V3RP3	V3RP2	V3RP1	V3RP0	0	0	V4RN5	V4RN4	V4RN3	V4RN2	V4RN1	V4RN0
R33	W	1	0	0	V4RP5	V4RP4	V4RP3	V4RP2	V4RP1	V4RP0	0	0	V3RN5	V3RN4	V3RN3	V3RN2	V3RN1	V3RN0
R34	W	1	0	0	V5RP5	V5RP4	V5RP3	V5RP2	V5RP1	V5RP0	0	0	V2RN5	V2RN4	V2RN3	V2RN2	V2RN1	V2RN0
R35	W	1	0	0	0	V6RP4	V6RP3	V6RP2	V6RP1	V6RP0	0	0	0	V1RN4	V1RN3	V1RN2	V1RN1	V1RN0
R36	W	1	0	0	0	V7RP4	V7RP3	V7RP2	V7RP1	V7RP0	0	0	0	V8RN4	V8RN3	V8RN2	V8RN1	V8RN0
R37	W	1	0	0	0	V8RP4	V8RP3	V8RP2	V8RP1	V8RP0	0	0	0	V7RN4	V7RN3	V7RN2	V7RN1	V7RN0
R38	W	1	0	0	0	0	V9RP3	V9RP2	V9RP1	V9RP0	0	0	0	0	V16RN3	V16RN2	V16RN1	V16RN0
R39	W	1	0	0	0	0	V10RP3	V10RP2	V10RP1	V10RP0	0	0	0	0	V15RN3	V15RN2	V15RN1	V15RN0
R3A	W	1	0	0	0	0	V11RP3	V11RP2	V11RP1	V11RP0	0	0	0	0	V14RN3	V14RN2	V14RN1	V14RN0
R3B	W	1	0	0	0	0	V12RP3	V12RP2	V12RP1	V12RP0	0	0	0	0	V13RN3	V13RN2	V13RN1	V13RN0
R3C	W	1	0	0	0	0	V13RP3	V13RP2	V13RP1	V13RP0	0	0	0	0	V12RN3	V12RN2	V12RN1	V12RN0
R3D	W	1	0	0	0	0	V14RP3	V14RP2	V14RP1	V14RP0	0	0	0	0	V11RN3	V11RN2	V11RN1	V11RN0
R3E	W	1	0	0	0	0	V15RP3	V15RP2	V15RP1	V15RP0	0	0	0	0	V10RN3	V10RN2	V10RN1	V10RN0
R3F	W	1	0	0	0	0	V16RP3	V16RP2	V16RP1	V16RP0	0	0	0	0	V9RN3	V9RN2	V9RN1	V9RN0

$\gamma$  Control (R30h to R3Fh): SPFD5408B provides 16 gamma registers to fine tune gamma output voltage.

V1RP[4:0]: register for positive VSD0 fine tune adjustment.  
V2RP[5:0]: register for positive VSD1 fine tune adjustment.  
V3RP[5:0]: register for positive VSD2 fine tune adjustment.  
V4RP[5:0]: register for positive VSD61 fine tune adjustment.  
V5RP[5:0]: register for positive VSD62 fine tune adjustment.  
V6RP[4:0]: register for positive VSD63 fine tune adjustment  
V7RP[4:0]: register for positive VSD13 fine tune adjustment  
V8RP[4:0]: register for positive VSD50 fine tune adjustment  
V9RP[3:0]: register for positive VSD4 fine tune adjustment  
V10RP[3:0]: register for positive VSD8 fine tune adjustment  
V11RP[3:0]: register for positive VSD20 fine tune adjustment  
V12RP[3:0]: register for positive VSD27 fine tune adjustment  
V13RP[3:0]: register for positive VSD36 fine tune adjustment  
V14RP[3:0]: register for positive VSD43 fine tune adjustment  
V15RP[3:0]: register for positive VSD55 fine tune adjustment  
V16RP[3:0]: register for positive VSD59 fine tune adjustment

V1RN[4:0]: register for negative VSD0 fine tune adjustment.  
V2RN[5:0]: register for negative VSD1 fine tune adjustment.  
V3RN[5:0]: register for negative VSD2 fine tune adjustment.  
V4RN[5:0]: register for negative VSD61 fine tune adjustment.  
V5RN[5:0]: register for negative VSD62 fine tune adjustment.  
V6RN[4:0]: register for negative VSD63 fine tune adjustment  
V7RN[4:0]: register for negative VSD13 fine tune adjustment  
V8RN[4:0]: register for negative VSD50 fine tune adjustment  
V9RN[3:0]: register for negative VSD4 fine tune adjustment  
V10RN[3:0]: register for negative VSD8 fine tune adjustment  
V11RN[3:0]: register for negative VSD20 fine tune adjustment  
V12RN[3:0]: register for negative VSD27 fine tune adjustment  
V13RN[3:0]: register for negative VSD36 fine tune adjustment  
V14RN[3:0]: register for negative VSD43 fine tune adjustment  
V15RN[3:0]: register for negative VSD55 fine tune adjustment  
V16RN[3:0]: register for negative VSD59 fine tune adjustment

**6.2.26. Window Horizontal RAM Address Start (R50h)**

R/W	RS	CB15	CB14	CB13	CB12	CB11	CB10	CB9	CB8	CB7	CB6	CB5	CB4	CB3	CB2	CB1	CB0
W	1	0	0	0	0	0	0	0	0	HSA7	HSA6	HSA5	HSA4	HSA3	HSA2	HSA1	HSA0

**6.2.27. Window Horizontal RAM Address End (R51h)**

R/W	RS	CB15	CB14	CB13	CB12	CB11	CB10	CB9	CB8	CB7	CB6	CB5	CB4	CB3	CB2	CB1	CB0
W	1	0	0	0	0	0	0	0	0	HEA7	HEA6	HEA5	HEA4	HEA3	HEA2	HEA1	HEA0



**6.2.28. Window Vertical RAM Address Start (R52h)**

R/W	RS	CB15	CB14	CB13	CB12	CB11	CB10	CB9	CB8	CB7	CB6	CB5	CB4	CB3	CB2	CB1	CB0
W	1	0	0	0	0	0	0	0	VSA8	VSA7	VSA6	VSA5	VSA4	VSA3	VSA2	VSA1	VSA0

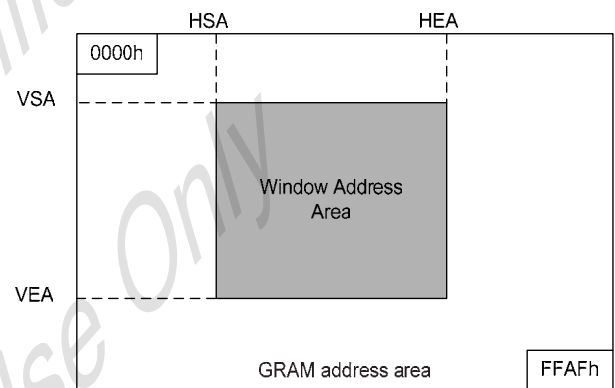
**6.2.29. Window Vertical RAM Address End (R53h)**

R/W	RS	CB15	CB14	CB13	CB12	CB11	CB10	CB9	CB8	CB7	CB6	CB5	CB4	CB3	CB2	CB1	CB0
W	1	0	0	0	0	0	0	0	VEA8	VEA7	VEA6	VEA5	VEA4	VEA3	VEA2	VEA1	VEA0

**HSA7-0/HEA7-0:** SPFD5408B provides window access function. Set HSA7-0 and HEA7-0 represent the start address and end address of the window function in horizontal direction. To use window-accessing function, HSA and HEA bits must be set before starting RAM write operation. Be aware that "00"h ≤ HSA7-0 < HEA7-0 ≤ "EF"h and HEA-HSA ≥ "04h".

**VSA8-0/VEA8-0:** SPFD5408B provides window access function. Set VSA8-0 and VEA8-0 represent the start address and end address of the window in vertical direction. To use window-accessing function, VSA and VEA bits must be set before starting RAM write operation. Be aware that "00"h ≤ VSA8-0 < VEA8-0 ≤ 9'h13F.

Figure 6-24 illustrates the window-accessing function using R44 and R45.


**6.2.30. Driver Output Control (R60h)**

R/W	RS	CB15	CB14	CB13	CB12	CB11	CB10	CB9	CB8	CB7	CB6	CB5	CB4	CB3	CB2	CB1	CB0
W	1	GS	0	NL5	NL4	NL3	NL2	NL1	NL0	0	0	SCN5	SCN4	SCN3	SCN2	SCN1	SCN0

**SCN5-0:** Set the SCN5-0 bits can specify the starting position of the gate driver. The start position of gate driver is determined by the combination of the setting of GS and SM. **Table 6-28** summarized the starting position for each SCN5-0 setting.

Table 6-28 (when SM=0)

SC N5	SC N4	SC N3	SC N2	SC N1	SC N0	Scan Start Position (Gate line)	
						GS = "0"	GS = "1"
0	0	0	0	0	0	G1	G320
0	0	0	0	0	1	G9	G312
0	0	0	0	1	0	G17	G304
0	0	0	0	1	1	G25	G296
0	0	0	1	0	0	G33	G288
0	0	0	1	0	1	G41	G280
0	0	0	1	1	0	G49	G272
0	0	0	1	1	1	G57	G264
0	0	1	0	0	0	G65	G256
0	0	1	0	0	1	G73	G248

SC N5	SC N4	SC N3	SC N2	SC N1	SC N0	Scan Start Position (Gate line)	
						GS = "0"	GS = "1"
0	0	1	0	1	0	G81	G240
0	0	1	0	1	1	G89	G232
0	0	1	1	0	0	G97	G224
0	0	1	1	0	1	G105	G216
0	0	1	1	1	0	G113	G208
0	0	1	1	1	1	G121	G200
0	1	0	0	0	0	G129	G192
0	1	0	0	0	1	G137	G184
0	1	0	0	1	0	G145	G176
0	1	0	0	1	1	G153	G168
0	1	0	1	0	0	G161	G160
0	1	0	1	0	1	G169	G152
0	1	0	1	1	0	G177	G144
0	1	0	1	1	1	G185	G136
0	1	1	0	0	0	G193	G128
0	1	1	0	0	1	G201	G120
0	1	1	0	1	0	G209	G112

SC N5	SC N4	SC N3	SC N2	SC N1	SC N0	Scan Start Position (Gate line)	
						GS = "0"	GS = "1"
0	1	1	0	1	1	G217	G104
0	1	1	1	0	0	G225	G96
0	1	1	1	0	1	G233	G88
0	1	1	1	1	0	G241	G80
0	1	1	1	1	1	G249	G72
1	0	0	0	0	0	G257	G64
1	0	0	0	0	1	G265	G56
1	0	0	0	1	0	G273	G48

SC N5	SC N4	SC N3	SC N2	SC N1	SC N0	Scan Start Position (Gate line)	
						GS = "0"	GS = "1"
1	0	0	0	1	1	G281	G40
1	0	0	1	0	0	G289	G32
1	0	0	1	0	1	G297	G24
1	0	0	1	1	0	G305	G16
1	0	0	1	1	1	G313	G8
1	0	1	0	0	0	Setting disable	
Setting disable							
1	1	1	1	1	1	Setting	

**NL5-0:** Set the number of gate lines for different resolution of display panel. The combination of NL5-NL0 represents the gate line number are summarized at **Table 6-29**.

**Table 6-29**

NL5	NL4	NL3	NL2	NL1	NL0	Display Size	Lines	Driven gate lines
0	0	0	0	0	0	Setting disabled	Setting disabled	Setting disabled
Setting disable								
0	1	0	1	0	1	720 x 176 dots	176	G1 ~ G176
Setting disable								
0	1	1	1	0	1	720 x 240 dots	240	G1 ~ G240
0	1	1	1	1	0	720 x 248 dots	248	G1 ~ G248
0	1	1	1	1	1	720 x 256 dots	256	G1 ~ G256
1	0	0	0	0	0	720 x 264 dots	264	G1 ~ G264
1	0	0	0	0	1	720 x 272 dots	272	G1 ~ G272
1	0	0	0	1	0	720 x 280 dots	280	G1 ~ G280
1	0	0	0	1	1	720 x 288 dots	288	G1 ~ G288
1	0	0	1	0	0	720 x 296 dots	296	G1 ~ G296
1	0	0	1	0	1	720 x 304 dots	304	G1 ~ G304
1	0	0	1	1	0	720 x 312 dots	312	G1 ~ G312
1	0	0	1	1	1	720 x 320 dots	320	G1 ~ G320
Setting disable								

**Note:** Back porch and a front porch (set with BP/FP bits respectively) are inserted before/ after driving all gate lines,

**GS:** Shift direction of the gate driver output selection. When

GS="0", gate driver shift from G1 to G320. When GS = "1", gate driver shift from G320 to G1.

### 6.2.31. Driver Output Control (R61h)

R/W	RS	CB15	CB14	CB13	CB12	CB11	CB10	CB9	CB8	CB7	CB6	CB5	CB4	CB3	CB2	CB1	CB0	
W	1	0	0	0	0	0	0	0	0	0	0	0	0	0	0	NDL	VLE	REV

**REV:** To set the grayscale corresponding to normally white or normally black LCD panel from same data input.

Table 6-30 summarized REV bit function.

**Table 6-30**

REV	GRAM data	Source Driver Output	
		Positive Polarity	Negative Polarity
0	18'h00000	V63	V0
	18'h3FFFF	V0	V63
1	18'h00000	V0	V63
	18'h3FFFF	V63	V0

**VLE:** SPFD5408B provides vertical scrolling function which can be set by VLE bit.

VLE = "1", vertical scrolling function enable. The amount of scrolling line from the first line is determined by VL[8:0].

VLE = "0", normal display.

**NDL:** set the source driver output level in non-lit area..

NDL = "1", ..

NDL = "0", ..

### 6.2.32. Vertical Scroll Control (R6Ah)

R/W	RS	CB15	CB14	CB13	CB12	CB11	CB10	CB9	CB8	CB7	CB6	CB5	CB4	CB3	CB2	CB1	CB0
W	1	0	0	0	0	0	0	0	VL8	VL7	VL6	VL5	VL4	VL3	VL2	VL1	VL0

**VL8-0:** SPFD5408B provides scrolling function. The start position for displaying the image is shifted vertically by the number of lines based on the setting of the VL8-0 bits. Be aware that the vertical scrolling function is not available in the external (RGB) display interface mode. **Table 6-31** summarized the function of VL8-0 setting.

**Table 6-31**

VL8	VL7	VL6	VL5	VL4	VL3	VL2	VL1	VL0	Scrolling lines
0	0	0	0	0	0	0	0	0	0 line
0	0	0	0	0	0	0	0	1	1 line
0	0	0	0	0	0	0	1	0	2 lines
	:	:	:	:	:	:	:	:	:
1	0	0	1	1	1	1	1	1	319 lines
1	0	1	0	0	0	0	0	0	320 lines

**Note:** VL8-0 bits cannot set more than 320 lines.

### 6.2.33. Display Position – Partial Display 1 (R80h)

R/W	RS	CB15	CB14	CB13	CB12	CB11	CB10	CB9	CB8	CB7	CB6	CB5	CB4	CB3	CB2	CB1	CB0
W	1	0	0	0	0	0	0	0	PTD P08	PTD P07	PTD P06	PTD P05	PTD P04	PTD P03	PTD P02	PTD P01	PTD P00

### 6.2.34. RAM Address Start – Partial Display 1 (R81h)

R/W	RS	CB15	CB14	CB13	CB12	CB11	CB10	CB9	CB8	CB7	CB6	CB5	CB4	CB3	CB2	CB1	CB0
W	1	0	0	0	0	0	0	0	PTS A08	PTS A07	PTS A06	PTS A05	PTS A04	PTS A03	PTS A02	PTS A01	PTS A00

**6.2.35. RAM Address End – Partial Display 1 (R82h)**

R/W	RS	CB15	CB14	CB13	CB12	CB11	CB10	CB9	CB8	CB7	CB6	CB5	CB4	CB3	CB2	CB1	CB0
W	1	0	0	0	0	0	0	0	PTE A08	PTE A07	PTE A06	PTE A05	PTE A04	PTE A03	PTE A02	PTE A01	PTE A00

**6.2.36. Display Position – Partial Display 2 (R83h)**

R/W	RS	CB15	CB14	CB13	CB12	CB11	CB10	CB9	CB8	CB7	CB6	CB5	CB4	CB3	CB2	CB1	CB0
W	1	0	0	0	0	0	0	0	PTD P18	PTD P17	PTD P16	PTD P15	PTD P14	PTD P13	PTD P12	PTD P11	PTD P10

**6.2.37. RAM Address Start – Partial Display 2 (R84h)**

R/W	RS	CB15	CB14	CB13	CB12	CB11	CB10	CB9	CB8	CB7	CB6	CB5	CB4	CB3	CB2	CB1	CB0
W	1	0	0	0	0	0	0	0	PTS A18	PTS A17	PTS A16	PTS A15	PTS A14	PTS A13	PTS A12	PTS A11	PTS A10

**6.2.38. RAM Address End – Partial Display 2 (R85h)**

R/W	RS	CB15	CB14	CB13	CB12	CB11	CB10	CB9	CB8	CB7	CB6	CB5	CB4	CB3	CB2	CB1	CB0
W	1	0	0	0	0	0	0	0	PTE A18	PTE A17	PTE A16	PTE A15	PTE A14	PTE A13	PTE A12	PTE A11	PTE A10

**PTDP0[8:0]:** Set the physical starting position of partial display 1 on the LCD panel

**PTDP1[8:0]:** Set the physical starting position of partial display 2 on the LCD panel

The partial display 1 and partial display 2 should not overlap with each other. And make sure the PTDP0[8:0] < PTDP1[8:0].

**PTSA0[8:0]:** Set the start line address of display RAM of partial display 1 which will be display according to PTDP0[8:0].

**PTEA0[8:0]:** Set the end line address of display RAM of partial display 1 which will be display according to PTDP0[8:0].

Make sure PTSA0<=PTEA0

**PTSA1[8:0]:** Set the start line address of display RAM of partial display2 which will be display according to PTDP1[8:0].

**PTEA1[8:0]:** Set the end line address of display RAM of partial display2 which will be display according to PTDP1[8:0]

Make sure PTSA1<=PTEA1

**6.2.39. Panel Interface Control 1 (R90h)**

R/W	RS	CB15	CB14	CB13	CB12	CB11	CB10	CB9	CB8	CB7	CB6	CB5	CB4	CB3	CB2	CB1	CB0
W	1	0	0	0	0	0	0	DIV1	DIV0	0	0	0	RTNI4	RTNI3	RTNI2	RTNI1	RTNI0

**RTNI4-0:** Set the clock cycle per line **Table 6-32** summarized the function of RTNI4-0 setting.

**Table 6-32**

RTNI4	RTNI3	RTNI2	RTNI1	RTNI0	Clock Cycles per line
0	0	0	0	0	Setting disable
Setting disable					
1	0	0	0	0	16 clocks
1	0	0	0	1	17 clocks
1	0	0	1	0	18 clocks

RTNI4	RTNI3	RTNI2	RTNI1	RTNI0	Clock Cycles per line
1	0	0	1	1	19 clocks
1	0	1	0	0	20 clocks
1	0	1	0	1	21 clocks
1	0	1	1	0	22 clocks
1	0	1	1	1	23 clocks
1	1	0	0	0	24 clocks
1	1	0	0	1	25 clocks
1	1	0	1	0	26 clocks
1	1	0	1	1	27 clocks
1	1	1	0	0	28 clocks
1	1	1	0	1	29 clocks
1	1	1	1	0	30 clocks
1	1	1	1	1	31 clocks

**DIV11-0:** To specified the division ratio of internal operation clock frequency. Set the RTN and DIV1 bits to adjust frame frequency. Be aware of that if the number of lines for driving liquid crystal is changed, the frame frequency must also be adjusted. Moreover, In RGB interface mode, the DIV11-0 bits are disabled. **Table 6-33** summarized the function of DIV11-0 setting.

**Table 6-33**

DIV1	DIV0	Division Ratio	Internal Operation Clock Frequency
0	0	1	fosc / 1
0	1	2	fosc / 2
1	0	4	fosc / 4
1	1	8	fosc / 8

fosc =Frequency of RC oscillation

Formula to calculate frame frequency

$$\text{Frame frequency} = \frac{\text{fosc}}{\text{Clock cycles per line} \times \text{division ratio} \times (\text{Line} + \text{BP} + \text{FP})} \quad [\text{Hz}]$$

**fosc:** frequency of RC oscillation

**Line:** number of lines for driving liquid crystal (NL bits)

**Division ratio:** DIV1 bits

**Clock cycles per line:** RTNI bits

**FP:** the number of lines for the front porch period

**BP:** the number of lines for the back porch period

#### 6.2.40. Panel Interface Control 2 (R92h)

R/W	RS	CB15	CB14	CB13	CB12	CB11	CB10	CB9	CB8	CB7	CB6	CB5	CB4	CB3	CB2	CB1	CB0
W	1	0	0	0	0	0	NOWI2	NOWI1	NOWI0	0	0	0	0	0	0	0	0

**NOWI [2:0]:** Set the adjacent gate driver output non-overlap period. **Table 6-34** summarized the function of NOWI2-0 setting.

**Table 6-34**

NOWI2	NOWI1	NOWI0	Gate output non-overlap period Internal Operation (reference clock: internal oscillator)
0	0	0	0 clock
0	0	1	1 clocks
0	1	0	2 clocks
0	1	1	3 clocks
1	0	0	4 clocks
1	0	1	5 clocks
1	1	0	6 clocks
1	1	1	7 clocks

**6.2.41. Panel Interface control 3 (R93h)**

R/W	RS	CB15	CB14	CB13	CB12	CB11	CB10	CB9	CB8	CB7	CB6	CB5	CB4	CB3	CB2	CB1	CB0
W	1	0	0	0	0	0	0	0	0	0	0	0	0	0	MCP I2	MCP I1	MCP I0

**MCPI[2:0]:** Set source driver start output timing. The source driver output position is measure from internal reference point.

MCPI2	MCPI1	MCPI0	Source driver start output position
0	0	0	0 clock
0	0	1	1 clocks
0	1	0	2 clocks
0	1	1	3 clocks
1	0	0	4 clocks
1	0	1	5 clocks
1	1	0	6 clocks
1	1	1	7 clocks

**6.2.42. Panel Interface control 4 (R95h)**

R/W	RS	CB15	CB14	CB13	CB12	CB11	CB10	CB9	CB8	CB7	CB6	CB5	CB4	CB3	CB2	CB1	CB0
W	1	0	0	0	0	0	0	DIVE1	DIVE0	0	0	RTNE5	RTNE4	RTNE3	RTNE2	RTNE1	RTNE0

**RTNE5-0:** Set the clock cycle per line **Table 6-35** summarized the function of RTNE5-0 setting.

**Table 6-35**

RTNE5	RTNE4	RTNE3	RTNE2	RTNE1	RTNE0	Clock Cycles per line
0	0	0	0	0	0	Setting disable
Setting disable						
0	1	0	0	0	0	16 clocks
0	1	0	0	0	1	17 clocks
0	1	0	0	1	0	18 clocks
0	1	0	0	1	1	19 clocks
0	1	0	1	0	0	20 clocks
0	1	0	1	0	1	21 clocks
0	1	0	1	1	0	22 clocks
0	1	0	1	1	1	23 clocks
0	1	1	0	0	0	24 clocks
0	1	1	0	0	1	25 clocks
0	1	1	0	1	0	26 clocks
0	1	1	0	1	1	27 clocks
0	1	1	1	0	0	28 clocks
0	1	1	1	0	1	29 clocks
0	1	1	1	1	0	30 clocks
0	1	1	1	1	1	31 clocks
1	1	0	0	0	0	32 clocks
1	1	0	0	0	1	33 clocks
1	1	0	0	1	0	34 clocks

RTNE5	RTNE4	RTNE3	RTNE2	RTNE1	RTNE0	Clock Cycles per line
1	1	0	0	1	1	35 clocks
1	1	0	1	0	0	36 clocks
1	1	0	1	0	1	37 clocks
1	1	0	1	1	0	38 clocks
1	1	0	1	1	1	39 clocks
1	1	1	0	0	0	40 clocks
1	1	1	0	0	1	41 clocks
1	1	1	0	1	0	42 clocks
1	1	1	0	1	1	43 clocks
1	1	1	1	0	0	44 clocks
1	1	1	1	0	1	45 clocks
1	1	1	1	1	0	46 clocks
1	1	1	1	1	1	47 clocks
1	1	0	0	0	0	48 clocks
1	1	0	0	0	1	49 clocks
1	1	0	0	1	0	50 clocks
1	1	0	0	1	1	51 clocks
1	1	0	1	0	0	52 clocks
1	1	0	1	0	1	53 clocks
1	1	0	1	1	0	54 clocks
1	1	0	1	1	1	55 clocks
1	1	1	0	0	0	56 clocks
1	1	1	0	0	1	57 clocks
1	1	1	0	1	0	58 clocks
1	1	1	0	1	1	59 clocks
1	1	1	1	0	0	60 clocks
1	1	1	1	0	1	61 clocks
1	1	1	1	1	0	62 clocks
1	1	1	1	1	1	63 clocks

**DIVE1-0:** To specified the division ratio of internal operation clock frequency. Set the RTNE and DIVE bits to adjust frame frequency. Be aware of that if the number of lines for driving liquid crystal is changed, the frame frequency must also be adjusted. Moreover, In RGB interface mode, the DIVE1-0 bits are disabled. **Table 6-36** summarized the function of DIVE1-0 setting.

**Table 6-36**

DIVE1	DIVE0	Division Ratio	Internal Operation Clock Frequency
0	0	Setting disable	
0	1	4	fosc / 4
1	0	8	fosc / 8
1	1	16	fosc / 16

fosc =Frequency of RC oscillation

### 6.2.43. Panel Interface Control 5 (R97h)

R/W	RS	CB15	CB14	CB13	CB12	CB11	CB10	CB9	CB8	CB7	CB6	CB5	CB4	CB3	CB2	CB1	CB0
W	1	0	0	0	0	NOW E3	NOW E2	NOW E1	NOW E0	0	0	0	0	0	0	0	0

**NOWE [3:0]:** Set the adjacent gate driver output non-overlap period in RGB interface. **Table 6-37** summarized the function of NOWE3-0 setting.

**Table 6-37**

NOWE3	NOWE2	NOWE1	NOWE0	Gate output non-overlap period Internal Operation (reference clock: internal oscillator)
0	0	0	0	0 clocks
0	0	0	1	1 clocks
0	0	1	0	2 clocks
0	0	1	1	3 clocks
0	1	0	0	4 clocks
0	1	0	1	5 clocks
0	1	1	0	6 clocks
0	1	1	1	7 clocks
1	0	0	0	8 clocks
1	0	0	1	9 clocks
1	0	1	0	10 clocks
1	0	1	1	11 clocks
1	1	0	0	12 clocks
1	1	0	1	13 clocks
1	1	1	0	14 clocks
1	1	1	1	15 clocks



#### 6.2.44. Panel Interface Control 6 (R98h)

R/W	RS	CB15	CB14	CB13	CB12	CB11	CB10	CB9	CB8	CB7	CB6	CB5	CB4	CB3	CB2	CB1	CB0
W	1	0	0	0	0	0	0	0	0	0	0	0	0	0	MCP E2	MCP E1	MCP E0

**MCPE[2:0]:** Set source driver start output timing in RGB interface. The source driver output position is measure from internal reference point.

MCPE2	MCPE1	MCPE0	Source driver start output position
0	0	0	0 clock
0	0	1	1 clocks
0	1	0	2 clocks
0	1	1	3 clocks
1	0	0	4 clocks
1	0	1	5 clocks
1	1	0	6 clocks
1	1	1	7 clocks

#### 6.2.45. Calibration Control (RA4h)

R/W	RS	CB15	CB14	CB13	CB12	CB11	CB10	CB9	CB8	CB7	CB6	CB5	CB4	CB3	CB2	CB1	CB0
W	1	0	0	0	0	0	0	0	0	0	0	0	0	0	0	0	CALB

**CALB:** .the enable bit for the read function of the NVM.

When CALB="1": Read function from NVM is enable.

When CALB="0": Read function from NVM is disable.

**7. GRAM**
**Table 7-1 GRAM address and display panel position (SS = "0")**

S/G pin		S1	S2	S3	S4	S5	S6	S7	S8	S9	S10	S11	S12	...	S709	S710	S711	S712	S713	S714	S715	S716	S717	S718	S719	S720	
GS=0	GS=1	DB17-0			DB17-0			DB17-0			DB17-0			...	DB17-0			DB17-0			DB17-0			DB17-0			
G1	G320	"00000"H	"00001"H	"00002"H	"00003"H	"00004"H	"00005"H	"00006"H	"00007"H	"00008"H	"00009"H	"00010"H	"00011"H	"00012"H	...	"000EC"H	"000ED"H	"000EE"H	"000EF"H	"000F0"H	"000F1"H	"000F2"H	"000F3"H	"000F4"H	"000F5"H	"000F6"H	"000F7"H
G2	G319	"00100"H	"00101"H	"00102"H	"00103"H	"00104"H	"00105"H	"00106"H	"00107"H	"00108"H	"00109"H	"00110"H	"00111"H	"00112"H	...	"001EC"H	"001ED"H	"001EE"H	"001EF"H	"001F0"H	"001F1"H	"001F2"H	"001F3"H	"001F4"H	"001F5"H	"001F6"H	"001F7"H
G3	G318	"00200"H	"00201"H	"00202"H	"00203"H	"00204"H	"00205"H	"00206"H	"00207"H	"00208"H	"00209"H	"00210"H	"00211"H	"00212"H	...	"002EC"H	"002ED"H	"002EE"H	"002EF"H	"002F0"H	"002F1"H	"002F2"H	"002F3"H	"002F4"H	"002F5"H	"002F6"H	"002F7"H
G4	G317	"00300"H	"00301"H	"00302"H	"00303"H	"00304"H	"00305"H	"00306"H	"00307"H	"00308"H	"00309"H	"00310"H	"00311"H	"00312"H	...	"003EC"H	"003ED"H	"003EE"H	"003EF"H	"003F0"H	"003F1"H	"003F2"H	"003F3"H	"003F4"H	"003F5"H	"003F6"H	"003F7"H
G5	G316	"00400"H	"00401"H	"00402"H	"00403"H	"00404"H	"00405"H	"00406"H	"00407"H	"00408"H	"00409"H	"00410"H	"00411"H	"00412"H	...	"004EC"H	"004ED"H	"004EE"H	"004EF"H	"004F0"H	"004F1"H	"004F2"H	"004F3"H	"004F4"H	"004F5"H	"004F6"H	"004F7"H
G6	G315	"00500"H	"00501"H	"00502"H	"00503"H	"00504"H	"00505"H	"00506"H	"00507"H	"00508"H	"00509"H	"00510"H	"00511"H	"00512"H	...	"005EC"H	"005ED"H	"005EE"H	"005EF"H	"005F0"H	"005F1"H	"005F2"H	"005F3"H	"005F4"H	"005F5"H	"005F6"H	"005F7"H
G7	G314	"00600"H	"00601"H	"00602"H	"00603"H	"00604"H	"00605"H	"00606"H	"00607"H	"00608"H	"00609"H	"00610"H	"00611"H	"00612"H	...	"006EC"H	"006ED"H	"006EE"H	"006EF"H	"006F0"H	"006F1"H	"006F2"H	"006F3"H	"006F4"H	"006F5"H	"006F6"H	"006F7"H
G8	G313	"00700"H	"00701"H	"00702"H	"00703"H	"00704"H	"00705"H	"00706"H	"00707"H	"00708"H	"00709"H	"00710"H	"00711"H	"00712"H	...	"007EC"H	"007ED"H	"007EE"H	"007EF"H	"007F0"H	"007F1"H	"007F2"H	"007F3"H	"007F4"H	"007F5"H	"007F6"H	"007F7"H
G9	G312	"00800"H	"00801"H	"00802"H	"00803"H	"00804"H	"00805"H	"00806"H	"00807"H	"00808"H	"00809"H	"00810"H	"00811"H	"00812"H	...	"008EC"H	"008ED"H	"008EE"H	"008EF"H	"008F0"H	"008F1"H	"008F2"H	"008F3"H	"008F4"H	"008F5"H	"008F6"H	"008F7"H
G10	G311	"00900"H	"00901"H	"00902"H	"00903"H	"00904"H	"00905"H	"00906"H	"00907"H	"00908"H	"00909"H	"00910"H	"00911"H	"00912"H	...	"009EC"H	"009ED"H	"009EE"H	"009EF"H	"009F0"H	"009F1"H	"009F2"H	"009F3"H	"009F4"H	"009F5"H	"009F6"H	"009F7"H
G11	G310	"00E00"H	"00E01"H	"00E02"H	"00E03"H	"00E04"H	"00E05"H	"00E06"H	"00E07"H	"00E08"H	"00E09"H	"00E10"H	"00E11"H	"00E12"H	...	"00EEC"H	"00EED"H	"00EEE"H	"00EEF"H	"00EF0"H	"00EF1"H	"00EF2"H	"00EF3"H	"00EF4"H	"00EF5"H	"00EF6"H	"00EF7"H
G12	G309	"00B00"H	"00B01"H	"00B02"H	"00B03"H	"00B04"H	"00B05"H	"00B06"H	"00B07"H	"00B08"H	"00B09"H	"00B10"H	"00B11"H	"00B12"H	...	"00BEC"H	"00BED"H	"00BEE"H	"00BEF"H	"00BF0"H	"00BF1"H	"00BF2"H	"00BF3"H	"00BF4"H	"00BF5"H	"00BF6"H	"00BF7"H
G13	G308	"00C00"H	"00C01"H	"00C02"H	"00C03"H	"00C04"H	"00C05"H	"00C06"H	"00C07"H	"00C08"H	"00C09"H	"00C10"H	"00C11"H	"00C12"H	...	"00CEC"H	"00CED"H	"00CEE"H	"00CEF"H	"00CF0"H	"00CF1"H	"00CF2"H	"00CF3"H	"00CF4"H	"00CF5"H	"00CF6"H	"00CF7"H
G14	G307	"00D00"H	"00D01"H	"00D02"H	"00D03"H	"00D04"H	"00D05"H	"00D06"H	"00D07"H	"00D08"H	"00D09"H	"00D10"H	"00D11"H	"00D12"H	...	"00DEC"H	"00DED"H	"00DEE"H	"00DEF"H	"00DF0"H	"00DF1"H	"00DF2"H	"00DF3"H	"00DF4"H	"00DF5"H	"00DF6"H	"00DF7"H
G15	G306	"00E00"H	"00E01"H	"00E02"H	"00E03"H	"00E04"H	"00E05"H	"00E06"H	"00E07"H	"00E08"H	"00E09"H	"00E10"H	"00E11"H	"00E12"H	...	"00EEC"H	"00EED"H	"00EEE"H	"00EEF"H	"00EF0"H	"00EF1"H	"00EF2"H	"00EF3"H	"00EF4"H	"00EF5"H	"00EF6"H	"00EF7"H
G16	G305	"00F00"H	"00F01"H	"00F02"H	"00F03"H	"00F04"H	"00F05"H	"00F06"H	"00F07"H	"00F08"H	"00F09"H	"00F10"H	"00F11"H	"00F12"H	...	"00FEC"H	"00FED"H	"00FEE"H	"00FEF"H	"00FF0"H	"00FF1"H	"00FF2"H	"00FF3"H	"00FF4"H	"00FF5"H	"00FF6"H	"00FF7"H
G17	G304	"01000"H	"01001"H	"01002"H	"01003"H	"01004"H	"01005"H	"01006"H	"01007"H	"01008"H	"01009"H	"01010"H	"01011"H	"01012"H	...	"010EC"H	"010ED"H	"010EE"H	"010EF"H	"010F0"H	"010F1"H	"010F2"H	"010F3"H	"010F4"H	"010F5"H	"010F6"H	"010F7"H
G18	G303	"01100"H	"01101"H	"01102"H	"01103"H	"01104"H	"01105"H	"01106"H	"01107"H	"01108"H	"01109"H	"01110"H	"01111"H	"01112"H	...	"011EC"H	"011ED"H	"011EE"H	"011EF"H	"011F0"H	"011F1"H	"011F2"H	"011F3"H	"011F4"H	"011F5"H	"011F6"H	"011F7"H
G19	G302	"01200"H	"01201"H	"01202"H	"01203"H	"01204"H	"01205"H	"01206"H	"01207"H	"01208"H	"01209"H	"01210"H	"01211"H	"01212"H	...	"012EC"H	"012ED"H	"012EE"H	"012EF"H	"012F0"H	"012F1"H	"012F2"H	"012F3"H	"012F4"H	"012F5"H	"012F6"H	"012F7"H
G20	G301	"01300"H	"01301"H	"01302"H	"01303"H	"01304"H	"01305"H	"01306"H	"01307"H	"01308"H	"01309"H	"01310"H	"01311"H	"01312"H	...	"013EC"H	"013ED"H	"013EE"H	"013EF"H	"013F0"H	"013F1"H	"013F2"H	"013F3"H	"013F4"H	"013F5"H	"013F6"H	"013F7"H
:	:	:	:	:	:	:	:	:	:	:	:	:	:	:	:	:	:	:	:	:	:	:	:	:	:	:	
:	:	:	:	:	:	:	:	:	:	:	:	:	:	:	:	:	:	:	:	:	:	:	:	:	:	:	
G313	G8	"13800"H	"13801"H	"13802"H	"13803"H	"13804"H	"13805"H	"13806"H	"13807"H	"13808"H	"13809"H	"13810"H	"13811"H	"13812"H	...	"138EC"H	"138ED"H	"138EE"H	"138EF"H	"138F0"H	"138F1"H	"138F2"H	"138F3"H	"138F4"H	"138F5"H	"138F6"H	"138F7"H
G314	G7	"13900"H	"13901"H	"13902"H	"13903"H	"13904"H	"13905"H	"13906"H	"13907"H	"13908"H	"13909"H	"13910"H	"13911"H	"13912"H	...	"139EC"H	"139ED"H	"139EE"H	"139EF"H	"139F0"H	"139F1"H	"139F2"H	"139F3"H	"139F4"H	"139F5"H	"139F6"H	"139F7"H
G315	G6	"13A00"H	"13A01"H	"13A02"H	"13A03"H	"13A04"H	"13A05"H	"13A06"H	"13A07"H	"13A08"H	"13A09"H	"13A10"H	"13A11"H	"13A12"H	...	"13AEC"H	"13AED"H	"13AEE"H	"13AEF"H	"13AF0"H	"13AF1"H	"13AF2"H	"13AF3"H	"13AF4"H	"13AF5"H	"13AF6"H	"13AF7"H
G316	G5	"13B00"H	"13B01"H	"13B02"H	"13B03"H	"13B04"H	"13B05"H	"13B06"H	"13B07"H	"13B08"H	"13B09"H	"13B10"H	"13B11"H	"13B12"H	...	"13BEC"H	"13BED"H	"13BEE"H	"13BEF"H	"13BF0"H	"13BF1"H	"13BF2"H	"13BF3"H	"13BF4"H	"13BF5"H	"13BF6"H	"13BF7"H
G317	G4	"13C00"H	"13C01"H	"13C02"H	"13C03"H	"13C04"H	"13C05"H	"13C06"H	"13C07"H	"13C08"H	"13C09"H	"13C10"H	"13C11"H	"13C12"H	...	"13CEC"H	"13CED"H	"13CEE"H	"13CEF"H	"13CF0"H	"13CF1"H	"13CF2"H	"13CF3"H	"13CF4"H	"13CF5"H	"13CF6"H	"13CF7"H
G318	G3	"13D00"H	"13D01"H	"13D02"H	"13D03"H	"13D04"H	"13D05"H	"13D06"H	"13D07"H	"13D08"H	"13D09"H	"13D10"H	"13D11"H	"13D12"H	...	"13DEC"H	"13DED"H	"13DEE"H	"13DEF"H	"13DF0"H	"13DF1"H	"13DF2"H	"13DF3"H	"13DF4"H	"13DF5"H	"13DF6"H	"13DF7"H
G319	G2	"13E00"H	"13E01"H	"13E02"H	"13E03"H	"13E04"H	"13E05"H	"13E06"H	"13E07"H	"13E08"H	"13E09"H	"13E10"H	"13E11"H	"13E12"H	...	"13EEC"H	"13EED"H	"13EEE"H	"13EEF"H	"13EF0"H	"13EF1"H	"13EF2"H	"13EF3"H	"13EF4"H	"13EF5"H	"13EF6"H	"13EF7"H
G320	G1	"13F00"H	"13F01"H	"13F02"H	"13F03"H	"13F04"H	"13F05"H	"13F06"H	"13F07"H	"13F08"H	"13F09"H	"13F10"H	"13F11"H	"13F12"H	...	"13FEC"H	"13FED"H	"13FEE"H	"13FEF"H	"13FF0"H	"13FF1"H	"13FF2"H	"13FF3"H	"13FF4"H	"13FF5"H	"13FF6"H	"13FF7"H

**Table 7-2** GRAM address and display panel position (SS = "1")

S/G pin		S1	S2	S3	S4	S5	...	S7	S8	S9	S10	S11	S12	...	S709	S710	S711	S712	S713	S714	S715	S716	S717	S718	S719	S720
GS=0	GS=1	DB17-0			DB17-0			DB17-0			DB17-0			...	DB17-0			DB17-0			DB17-0			DB17-0		
G1	G320	"000EF"H			"000EE"H			"000ED"H			"000EC"H			...	"00003"H			"00002"H			"00001"H			"00000"H		
G2	G319	"001EF"H			"001EE"H			"001ED"H			"001EC"H			...	"00103"H			"00102"H			"00101"H			"00100"H		
G3	G318	"002EF"H			"002AE"H			"002ED"H			"002EC"H			...	"00203"H			"00202"H			"00201"H			"00200"H		
G4	G317	"003EF"H			"003EE"H			"003ED"H			"003EC"H			...	"00303"H			"00302"H			"00301"H			"00300"H		
G5	G316	"004EF"H			"004EE"H			"004ED"H			"004EC"H			...	"00403"H			"00402"H			"00401"H			"00400"H		
G6	G315	"005EF"H			"005EE"H			"005ED"H			"005EC"H			...	"00503"H			"00502"H			"00501"H			"00500"H		
G7	G314	"006EF"H			"006EE"H			"006ED"H			"006EC"H			...	"00603"H			"00602"H			"00601"H			"00600"H		
G8	G313	"007EF"H			"007EE"H			"007ED"H			"007EC"H			...	"00703"H			"00702"H			"00701"H			"00700"H		
G9	G312	"008EF"H			"008EE"H			"008ED"H			"008EC"H			...	"00803"H			"00802"H			"00801"H			"00800"H		
G10	G311	"009EF"H			"009EE"H			"009ED"H			"009EC"H			...	"00903"H			"00902"H			"00901"H			"00900"H		
G11	G310	"00AEF"H			"00AEE"H			"00AED"H			"00AEC"H			...	"00E03"H			"00A02"H			"00A01"H			"00A00"H		
G12	G309	"00BEF"H			"00BEE"H			"00BED"H			"00BEC"H			...	"00B03"H			"00B02"H			"00B01"H			"00B00"H		
G13	G308	"00CEF"H			"00CEE"H			"00CED"H			"00CEC"H			...	"00C03"H			"00C02"H			"00C01"H			"00C00"H		
G14	G307	"00DEF"H			"00DEE"H			"00DED"H			"00DEC"H			...	"00D03"H			"00D02"H			"00D01"H			"00D00"H		
G15	G306	"00EEF"H			"00EEE"H			"00EED"H			"00EEC"H			...	"00E03"H			"00E02"H			"00E01"H			"00E00"H		
G16	G305	"00FEF"H			"00FEE"H			"00FED"H			"00FEC"H			...	"00F03"H			"00F02"H			"00F01"H			"00F00"H		
G17	G304	"010EF"H			"010EE"H			"010ED"H			"010EC"H			...	"01003"H			"01002"H			"01001"H			"01000"H		
G18	G303	"011EF"H			"011EE"H			"011ED"H			"011EC"H			...	"01103"H			"01102"H			"01101"H			"01100"H		
G19	G302	"012EF"H			"012EE"H			"012ED"H			"012EC"H			...	"01203"H			"01202"H			"01201"H			"01200"H		
G20	G301	"013EF"H			"013EE"H			"013ED"H			"013EC"H			...	"01303"H			"01302"H			"01301"H			"01300"H		
:	:	:	:	:	:	:	:	:	:	:	:	:	:	:	:	:	:	:	:	:	:	:	:	:	:	
:	:	:	:	:	:	:	:	:	:	:	:	:	:	:	:	:	:	:	:	:	:	:	:	:	:	
G233	G8	"E8EF"H			"138EE"H			"138ED"H			"138EC"H			...	"13803"H			"13802"H			"13801"H			"13800"H		
G234	G7	"139EF"H			"139EE"H			"139ED"H			"139EC"H			...	"13903"H			"13902"H			"13901"H			"13900"H		
G235	G6	"13AEF"H			"13AEE"H			"13AED"H			"13AEC"H			...	"13A03"H			"13A02"H			"13A01"H			"13A00"H		
G236	G5	"13BEF"H			"13BEE"H			"13BED"H			"13BEC"H			...	"13B03"H			"13B02"H			"13B01"H			"13B00"H		
G237	G4	"13CEF"H			"13CEE"H			"13CED"H			"13CEC"H			...	"13C03"H			"13C02"H			"13C01"H			"13C00"H		
G238	G3	"13DEF"H			"13DEE"H			"13DED"H			"13DEC"H			...	"13D03"H			"13D02"H			"13D01"H			"13D00"H		
G239	G2	"13EEF"H			"13EEE"H			"13EED"H			"13EEC"H			...	"13E03"H			"13E02"H			"13E01"H			"13E00"H		
G240	G1	"13FEF"H			"13FEE"H			"13FED"H			"13FEC"H			...	"13F03"H			"13F02"H			"13F01"H			"13F00"H		

## 8. INTERFACES

The SPFD5408B provides different interfaces to meet the diverse need of small/medium size LCD. Based on the application requirement, there are three different display modes which are most used in end product.

1. Still picture display
2. Moving picture display.
3. Re-writing still pictures while moving picture are display.

For above three different display requirements, SPFD5408B provides different interfaces to meet the requirement.

1. System interface
2. External interface (RGB interface)
3. VSYNC interface

System interface is suitable for still picture display while RGB interface and VSYNC interface are suitable for moving picture display. Be aware that RGB or VSYNC interface still can used to display still picture and system interface can also display moving picture. **Table 8-1** summarized different interfaces for different display requirement.

**Table 8-1**

Operation Mode	Display Mode	RAM Access Setting (RM)	Display Operation Mode (DM1-0)
System	Still picture	System interface (RM = 0)	Internal operating clock (DM1-0 = 00)
RGB interface (1)	Moving picture	RGB interface (RM = 1)	RGB interface (DM1-0 = 01)
RGB interface (2)	Rewriting still pictures while displaying moving pictures	System interface (RM = 0)	RGB interface (DM1-0 = 01)
VSYNC interface	Moving pictures	System interface (RM = 0)	VSYNC interface (DM1-0 = 10)

### 8.1. System Interface

The system interfaces of SPFD5408B can support 8-bit, 9-bit, 16-bit, 18-bit 80-system Interface and Serial Peripheral Interface (SPI), which can be set by the IM3/2/1/0 pins. The system

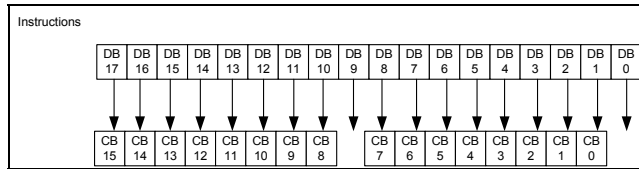
interface can set instructions and access RAM. **Table 8-2** summarized the interface corresponding to IM3-0 setting.

**Table 8-2**

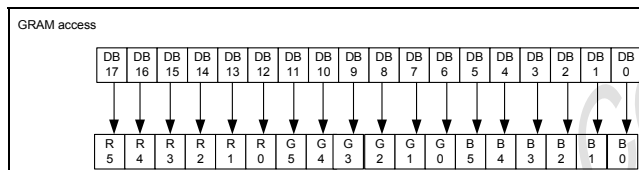
IM3	IM2	IM1	IM0	MPU-Interface Mode	DB Pin in use
0	0	0	0	Setting disabled	-
0	0	0	1	Setting disabled	-
0	0	1	0	80-system 16-bit interface	DB17 to 10 and 8 to 1
0	0	1	1	80-system 8-bit interface	DB17 to 10
0	1	0	*	Serial peripheral interface (SPI)	DB1 to 0
0	1	1	0	Setting disabled	-
1	0	0	0	Setting disabled	-
1	0	0	1	Setting disabled	-
1	0	1	0	80-system 18-bit interface	DB17 to 0
1	0	1	1	80-system 9-bit interface	DB17 to 9
1	1	*	*	Setting disabled -	-

### 8.1.1. 80-system 18-bit interface

The instruction and GRAM accessing format of 80-system 18-bit interface are shown in **Figure 8-1** and **Figure 8-2**, respectively.



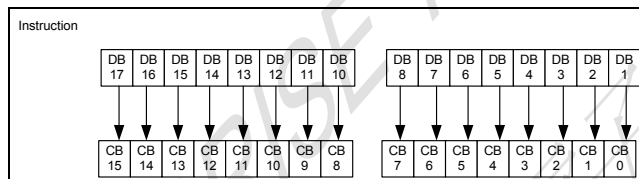
**Figure 8-1**



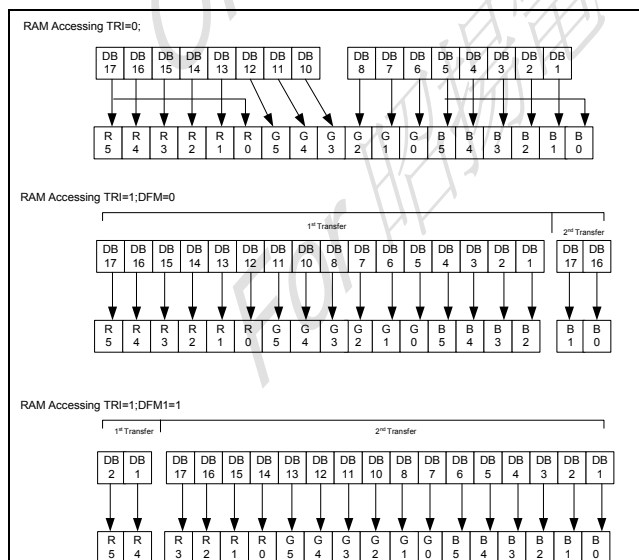
**Figure 8-2**

### 8.1.2. 80-system 16-bit interface

The instruction and GRAM accessing format of 80-system 16-bit interface are shown in **Figure 8-3** and **Figure 8-4**, respectively.



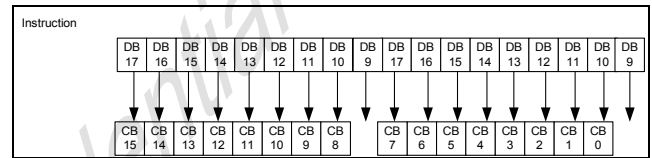
**Figure 8-3**



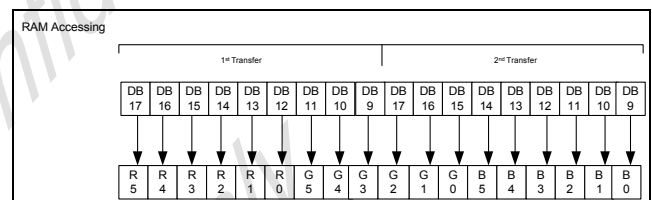
**Figure 8-4**

### 8.1.3. 80-system 9-bit interface

The instruction and GRAM accessing format of 80-system 9-bit interface are shown in **Figure 8-5** and **Figure 8-6**, respectively.



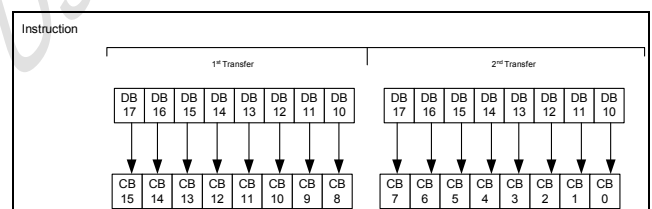
**Figure 8-5**



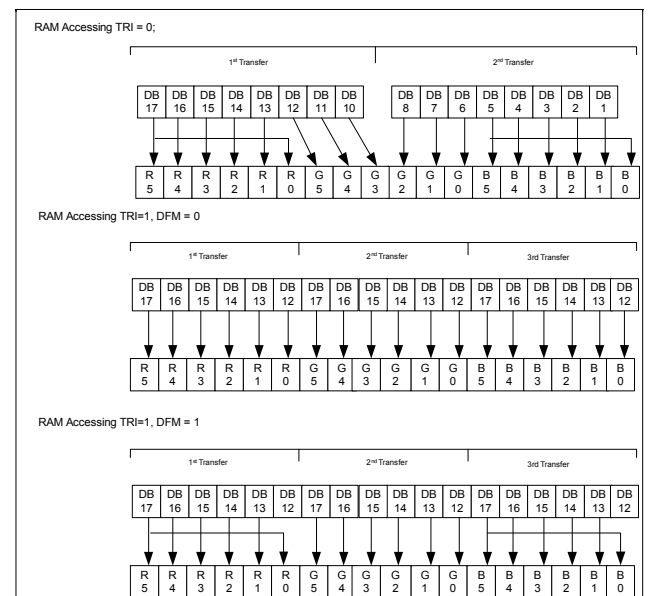
**Figure 8-6**

### 8.1.4. 80-system 8-bit interface

The instruction and GRAM accessing format of 80-system 8-bit interface are shown in **Figure 8-7** and **Figure 8-8**, respectively.



**Figure 8-7**



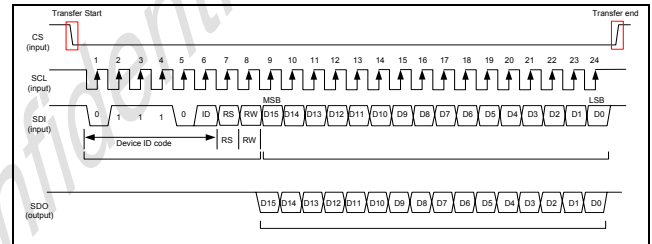
**Figure 8-8**

### 8.1.5. Serial Peripheral interface (SPI)

The system interface of SPFD5408B also includes the Serial Peripheral Interface (SPI). In SPI mode, /CS, SCL, SDI and SDO are used to transfer data between MCU and SPFD5408B. IM0/ID pin served as the ID pin. **Figure 8-9** illustrates the detail timing while using SPI. Be aware that the unused pins such as DB17-0 pins must be fixed at either IOVCC or GND level.

The instruction and GRAM accessing format of SPI interface are shown in **Figure 8-10** and **Figure 8-11**, respectively.

When read operation is desired In SPI mode, valid data are read out as the SPFD5408B reads out the 6th byte data from the internal GRAM. The RAM data transfer in SPI mode, in SPI mode with status read are illustrated in **Figure 8-12**, respectively.



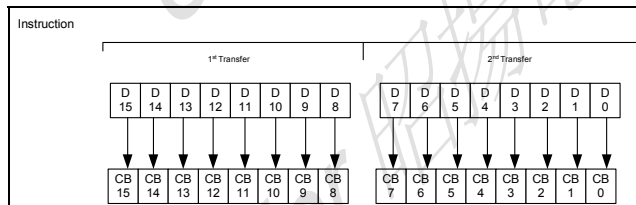
**Figure 8-9**

#### Start Byte Format

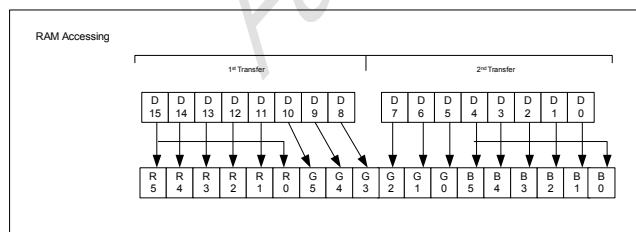
Transferred bits	S	1	2	3	4	5	6	7	8
Start byte format	Transfer start	Device ID code						RS	R/W
		0	1	1	1	0	ID		

Note 1) ID bit is selected by setting the IM0/ID pin.

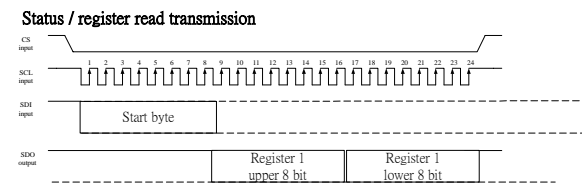
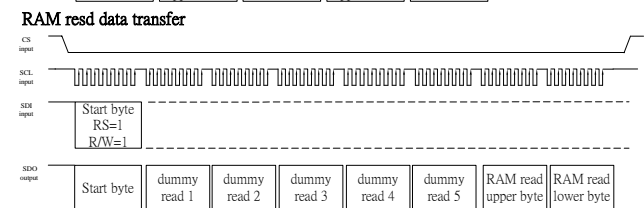
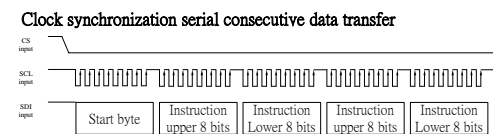
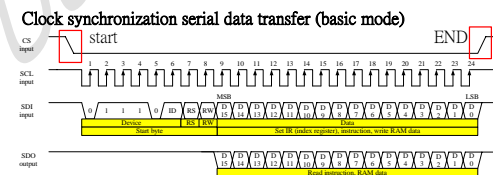
RS	R/W	Function
0	0	Set an index register
0	1	Read a status
1	0	Write an instruction or RAM data
1	1	Read an instruction or RAM data



**Figure 8-10**



**Figure 8-11**



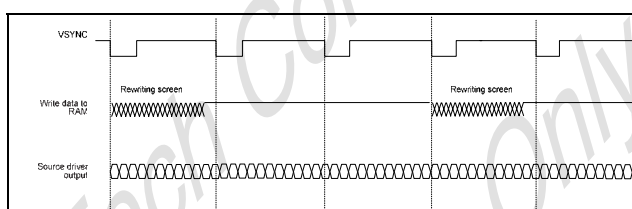
**Figure 8-12**

## 8.2. VSYNC Interface

The SPFD5408B also supports VSYNC interface for moving picture display, which is the system interface in synchronization with the frame-synchronizing signal (VSYNC). The VSYNC interface can display a moving picture without tremendous modification.

DM1-0 = "10" and RM = "0" can initialize VSYNC interface. In VSYNC interface mode, the internal display operation is synchronized with the VSYNC signal. In VSYNC interface mode, the graphic data are stored in GRAM to minimize the data transfer to overwrite on the moving picture GRAM area. **Figure 8-13** illustrates moving picture data transfer through VSYNC interface.

In VSYNC mode, internal operation is executed in synchronization with the internal clock generated from internal oscillators and VSYNC input. Therefore the frame rate is determined by the frequency of VSYNC. SPFD5408B can access the internal RAM in high speed with less power consumption in VSYNC interface mode while using high-speed write mode.



**Figure 8-13**

In VSYNC interface mode, the formula for Internal clock frequency and frame rate is shown below:

$$\text{Input clock frequency} = \text{FrameRate} \times (\text{DisplayLines} + \text{FrontPorch} + \text{BackPorch} \times 16 \times \text{variance})$$

Due to the possible cause of variances while set the internal clock frequency; be sure to complete the display operation in one VSYNC cycle.

### 8.3. External Display Interface

SPFD5408B also includes external (RGB) interface for displaying moving picture. External interface can be set by RIM1-0 bit. **Table 8-3** summarized the corresponding types of RGB interface with RIM1-0 setting.

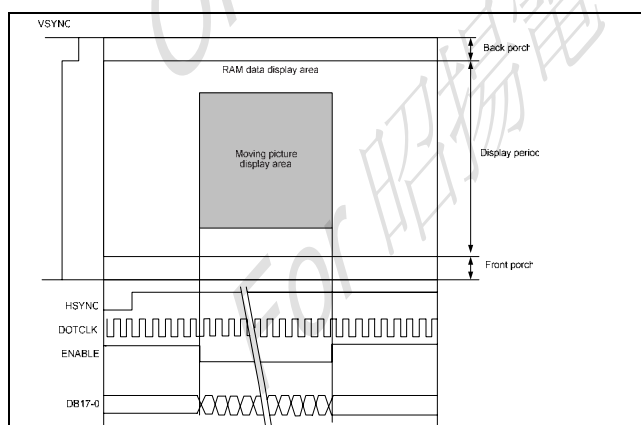
**Table 8-3**

RIM1	RIM0	RGB Interface	DB Pin
0	0	18-bit RGB interface	DB17-0
0	1	16-bit RGB interface	DB17-10, 8-1
1	0	6-bit RGB interface	DB17-12
1	1	Setting disabled	

RGB interface can access SPFD5408B by VSYNC, HSYNC, ENABLE, DOTCLK and DB17-0 signals, where VSYNC is used for frame synchronization; HSYNC is used for line synchronization and ENABLE is served as the valid data synchronized signals. The RGB interface can be rewriting minimum necessary data to the GRAM area which need to be overwritten with use of window address function and high-speed write mode. It is necessary for RGB interface to set front and back porch periods after and before a display period, respectively.

**Figure 8-14** illustrates the general timing for RGB interface. There are some constrain while using RGB interface. The following summarized the conditions

- (a) Partial display/ scroll function / interface and graphics operation function are not available for RGB interface
- (b) In RGB interface VSYNC, HSYNC, and DOTCLK signals must be input through a display operation period.
- (c) The setting of the NO1-0 bits, STD1-0 bits and EQ1-0 bits are based on DOTCLK in RGB interface mode. In 6-bit RGB interface mode, it takes 3 DOTCLK inputs to transfer one pixel. Be aware data transfer in units of 3 DOTCLK inputs in 6-bit RGB interface mode is necessary. Set the cycle of each signal in 6-bit interface mode (VSYNC, HSYNC ENABLE, DB17-0) to input 3x clock to complete data transfer in units of pixels.
- (d) In RGB interface mode, the front porch period continues until the next VSYNC input is detected after drawing one frame.
- (e) In RGB interface mode, a GRAM address (DB17-0) is set in the address counter every frame on the falling edge of VSYNC.



**Figure 8-14**

RGB interface includes ENABLE signal served as valid data synchronized signals. Moreover, the active level for ENABLE can be set by EPL. The EPL bit inverts the polarity of ENABLE signal. **Table 8-4** summarized the setting of EPL and ENABLE active level for GRAM accessing. Setting both EPL and ENABLE bits to automatically update RAM address in the AC is necessary while writing data to the GRAM.

**Table 8-4**

EPL	ENABLE	RAM Write	RAM Address
0	0	Enabled	Updated
0	1	Disenabled	Retained
1	0	Disenabled	Retained
1	1	Enabled	Updated



SPFD5408B can support 18-bit, 16-bit and 6-bit RGB interface. The detail timing diagram for 18-bit, 16-bit and 6-bit RGB interface are shown in **Figure 8-15** and **Figure 8-16** respectively.

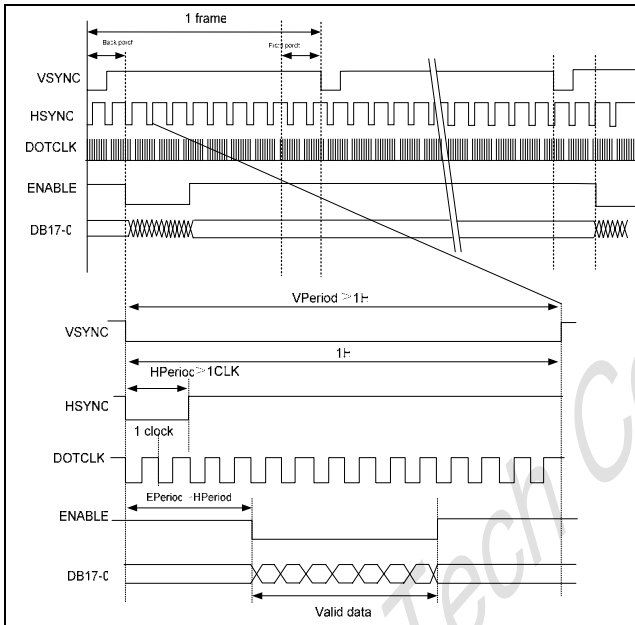


Figure 8-15

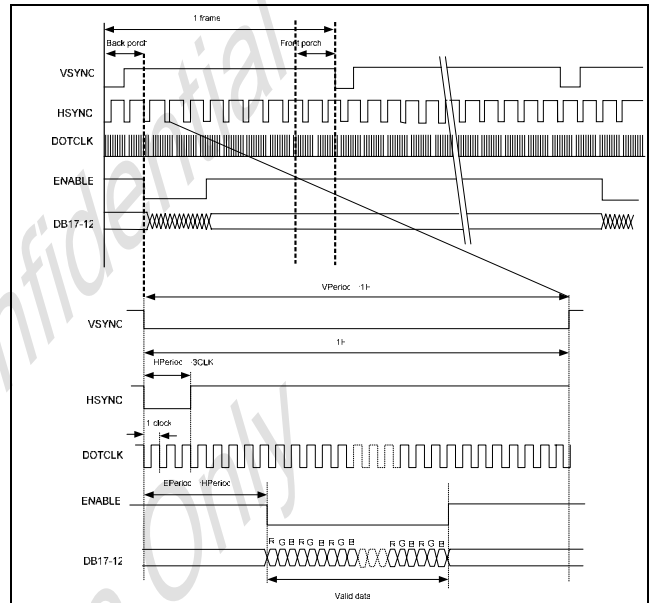


Figure 8-16

The RGB interface also has the window address function to transfer only minimum necessary data on the moving picture GRAM area, which can lower the power consumption and still can use system interface to rewrite data in still picture RAM area while displaying a moving picture. Setting RM = 0 while in RGB interface mode can make GRAM access through the system interface. When RGB interface accessing GRAM is desired, wait for one read/write bus cycle following by RM = 1 setting.

**Figure 8-17** illustrates the timing diagram when displaying a moving picture through the RGB interface and rewriting data in the still picture GRAM area through the system interface.

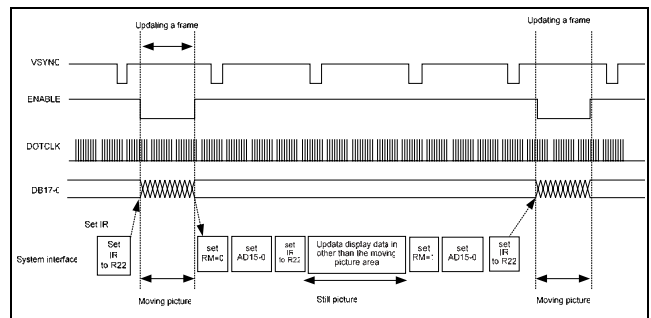


Figure 8-17

### 8.3.1. 6-bit RGB interface

RAM accessing format and data transmission synchronization of 6-bit RGB interface are shown in **Figure 8-18** and **Figure 8-19**, respectively.

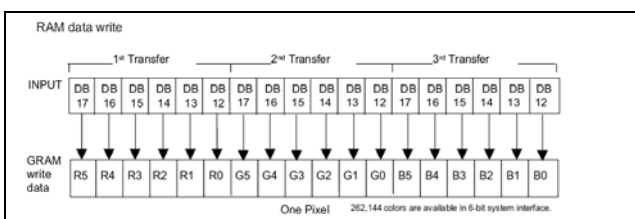


Figure 8-18

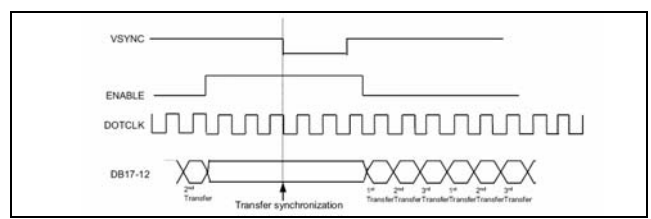


Figure 8-19

### 8.3.2. 16-bit RGB interface

RAM accessing format of 16-bit RGB interface are shown in Figure 8-20.

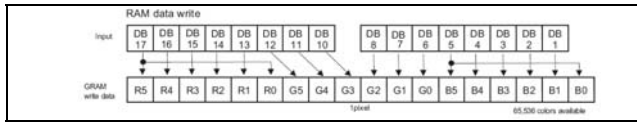


Figure 8-20

### 8.3.3. 18-bit RGB interface

RAM accessing format of 18-bit RGB interface are shown in Figure 8-21.

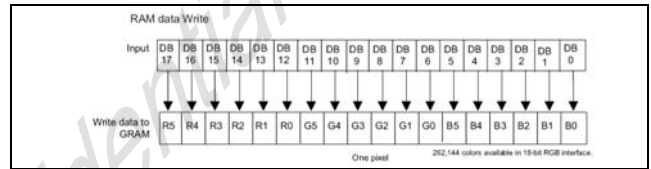
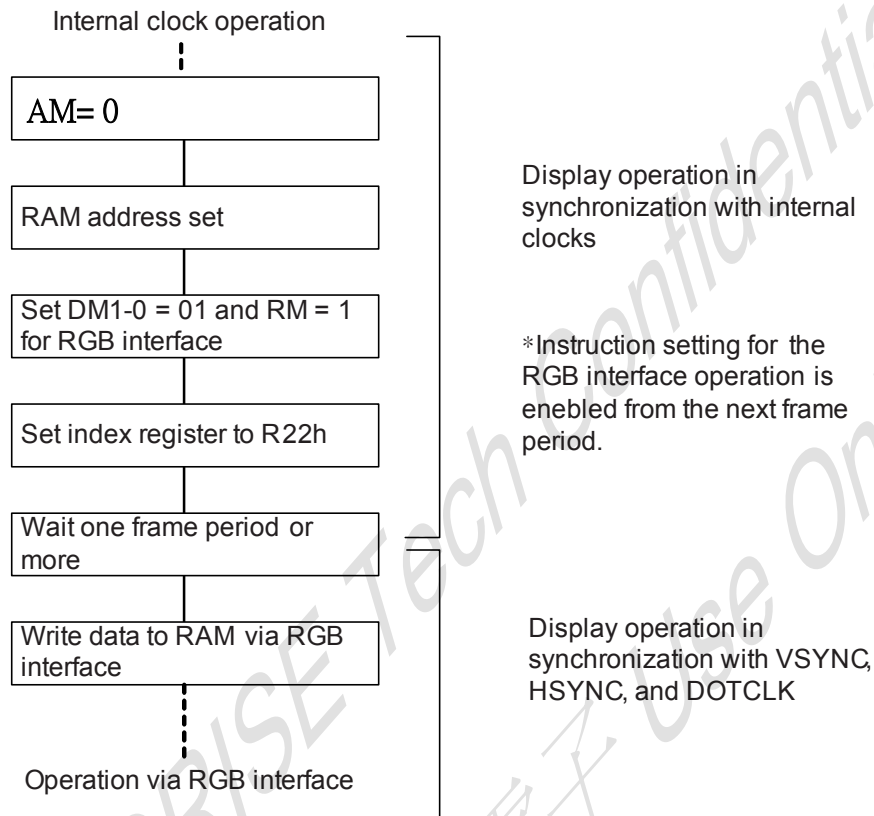


Figure 8-21

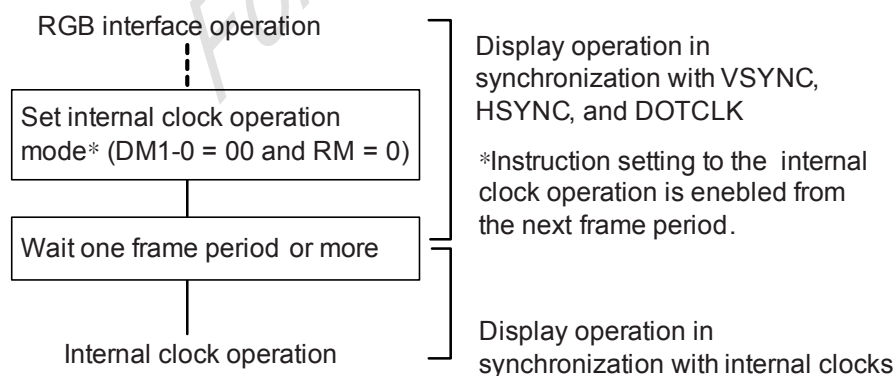
#### 8.4. Sequence to set between system interface and RGB interface:

##### Internal Clock Operation to RGB Interface (1)



Note: Input the RGB interface signals before setting the DM 1-0 and RM bits to the RGB interface operation.

##### RGB Interface (1) to Internal Clock Operation



Note: Continue RGB interface signals at least for one frame period after setting DM1-0, RM bits to internal clock operation.

## 9. Display Feature Function:

### 9.1. FMARK function:

SPFDF5408B provided FMARK function which output signal to alert host MCU via FMARK I/O pad so that LCD display can avoid flicker effect. FMARK output position and interval can be set by FMP[8:0] and FMI[2:0], respectively.

Figure 9-1 illustrated the FMARK output position when FMP[8:0]=9'h008.

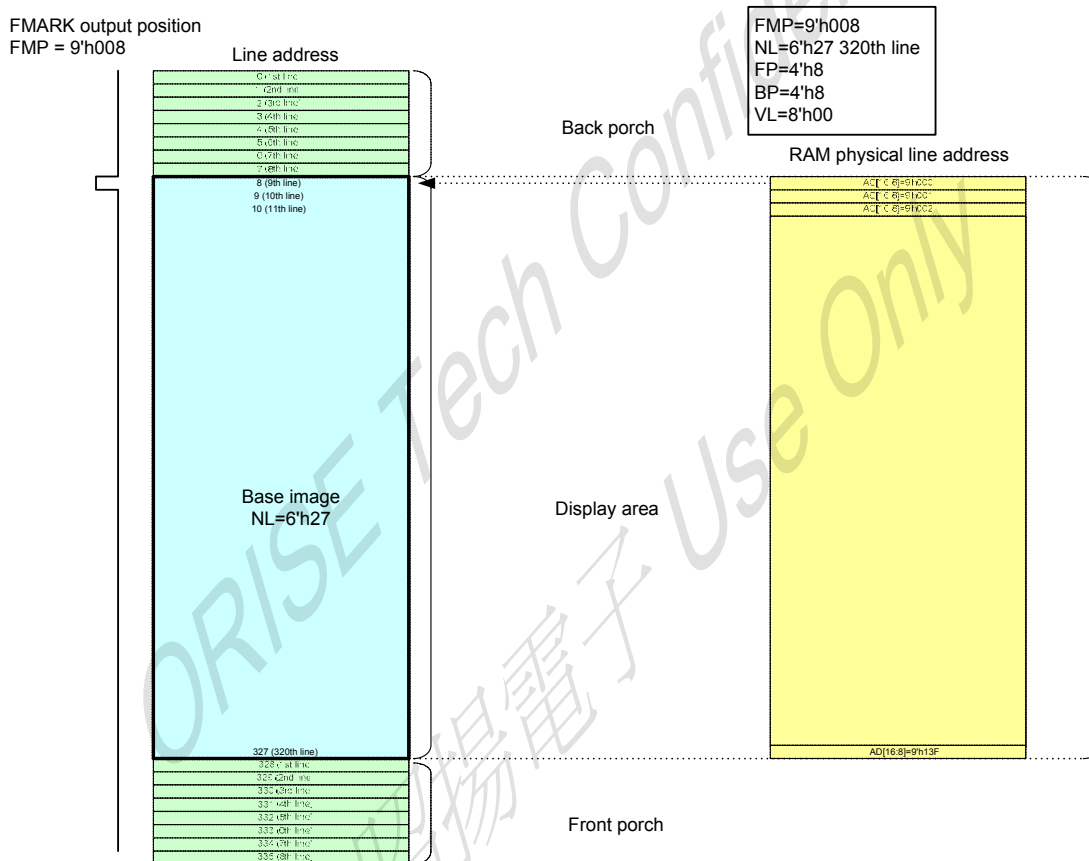


Figure 9-1 Example of FMARK signal.

9.2. Scan Mode function:

SM	GS	Scan Direction
0	0	<p>Scan Order: G1, G2, G3, G4,----- G317, G318, G319, G320</p>
0	1	<p>Scan Order: G320, G319, G318, G317,----- G4, G3, G2, G1</p>
1	0	<p>Scan Order: G1, G3, G5,----G317, G319, G2, G4, G6,----G318, G320</p>
1	1	<p>Scan Order: G320, G318, G316,----G4, G2, G319, G317, G315,----G3, G1</p>

### 9.3. Scaling function:

SPFD5408 provides scaling function to resize the display area. The Scaling factor can be set via RSZ[1:0] (register R04h, CB [1:0]). Table summarized the RSZ[1:0] function. The image after scaling can be displayed at the area set by (HSA, HEA, VSA, VFA).

**Table 9-1**

RSZ[1:0]	Scaling Factor	Actual resolution (original input data 240xRGBx320)
00	No scaling	240xRGBx320
01	1/2 scaling	120xRGBx160
10	Setting Disable	-
11	1/4 scaling	60xRGBx80

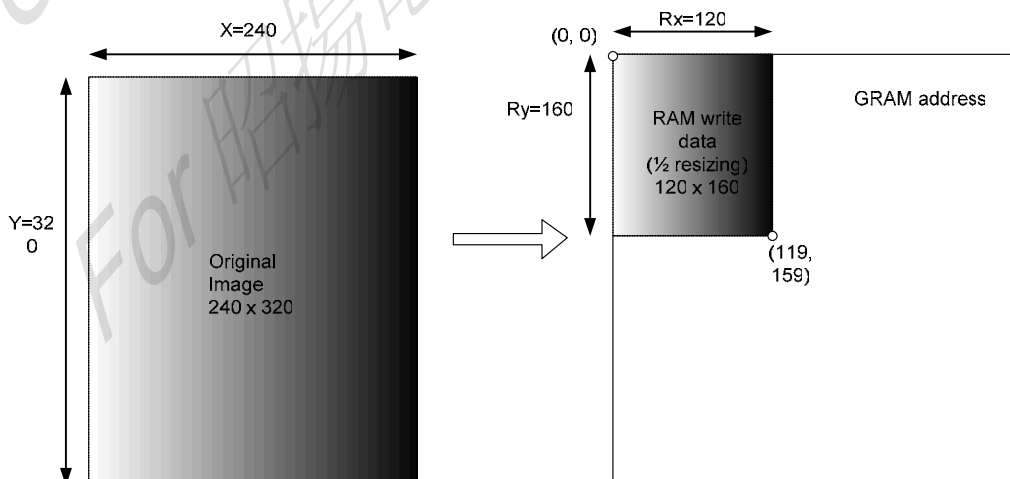
**Table 9-2** illustrated the data arrangement when scaling factor is 1/2, RSZ[1:0]="01"

	1	2	3	4	5	6	7	8
1	A1	A2	A3	A4	A5	A6	A7	A8
2	B1	B2	B3	B4	B5	B6	B7	B8
3	C1	C2	C3	C4	C5	C6	C7	C8
4	D1	D2	D3	D4	D5	D6	D7	D8
5	E1	E2	E3	E4	E5	E6	E7	E8
6	F1	F2	F3	F4	F5	F6	F7	F8
7	G1	G2	G3	G4	G5	G6	G7	G8
8	H1	H1	H3	H4	H5	H6	H7	H8

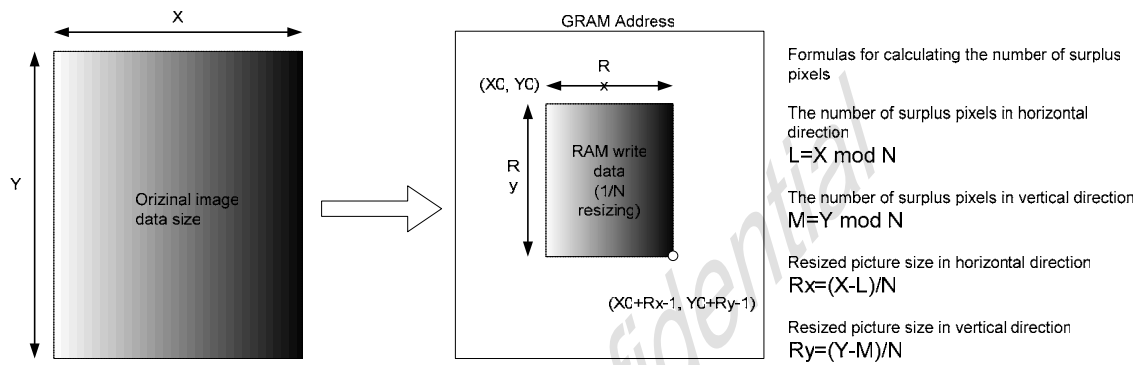


	1	2	3	4
1	A1	A3	A5	A7
2	C1	C3	C5	C7
3	E1	E3	E5	E7
4	G1	G3	G5	G7

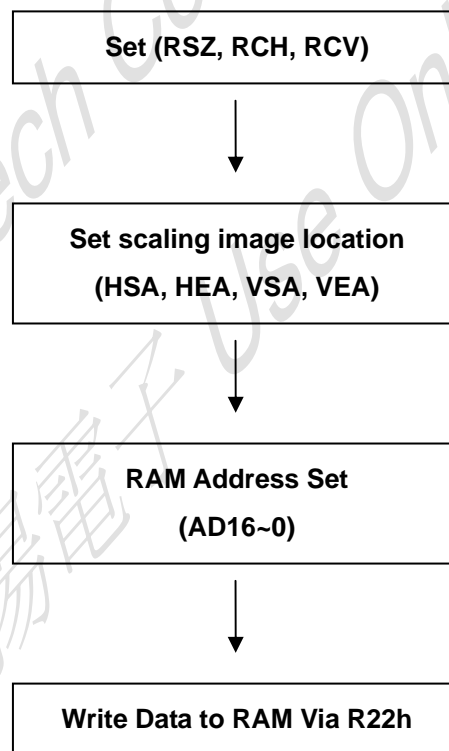
**Table 9-3** data arrangement



**Figure 9-2** illustrated the example when scaling factor is 1/2, RSZ[1:0]="01"



The flow chart to use scaling function:

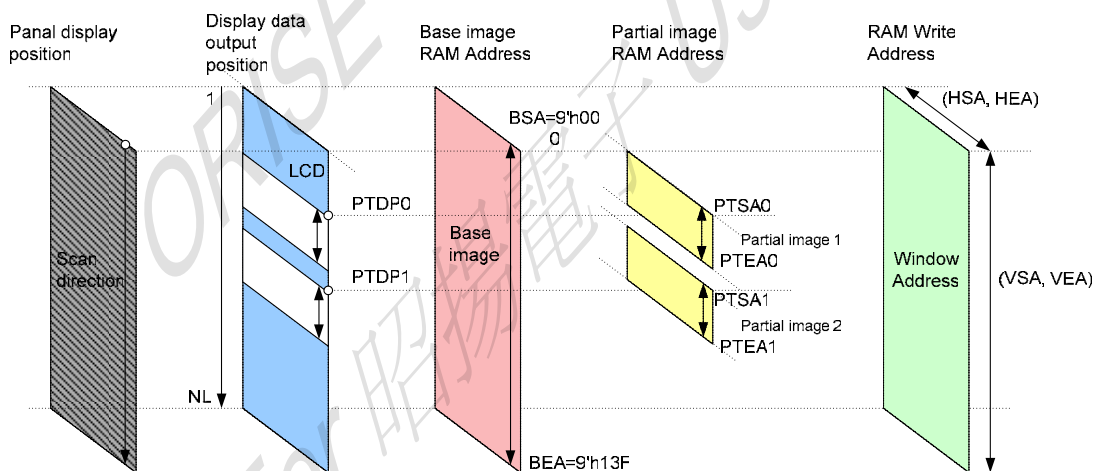


### 9.4. Partial Display function:

SPFD5408B has partial display function feature which can provide only partial display for power saving purpose. Partial display function can be accessed by setting BSEE="0". Moreover, 2 partial display area (partial image 1/ partial image 2) can be initialized by set PTDE0="1" and PTDE1="1", respectively. The partial display area for partial image 1 and partial 2 can be set by PTSA0 / PTEA0 and PTSA1/ PTEA1, respectively. **Table 9-4** and **Figure 9-3** summarized the full and partial display function.

**Table 9-4** Partial display function summary table

Case	Function Setting	Display area setting	Display Position
Full display	BASEE="1" PTDE0="x" PTDE1="x"	(BSA, BEA)	-
Partial image1:On Partial image2:Off	BASEE="0" PTDE0="1" PTDE1="0"	(PTSA0,PTEA0)	PTDP0
Partial image1:Off Partial image2:On	BASEE="0" PTDE0="0" PTDE1="1"	(PTSA1,PTEA1)	PTDP1
Partail image1:On Partial image2:On	BASEE="0" PTDE0="1" PTDE1="1"	(PTSA0,PTEA0) (PTSA1,PTEA1)	PTDP0 & PTDP1



**Figure 9-3** Partial display function diagram

**Figure 9-4** indicated the case of NL[5:0] setting is < 6'h27 which active line is less than 320. Partial display image data can stored in not active area.

**Figure 9-5** indicated the partial display area start position. The partial display area and start position can be set by (PTSA0, PTEA0, PTSA1, PTEA1) and (PTDP0, PTDP1), respectively.



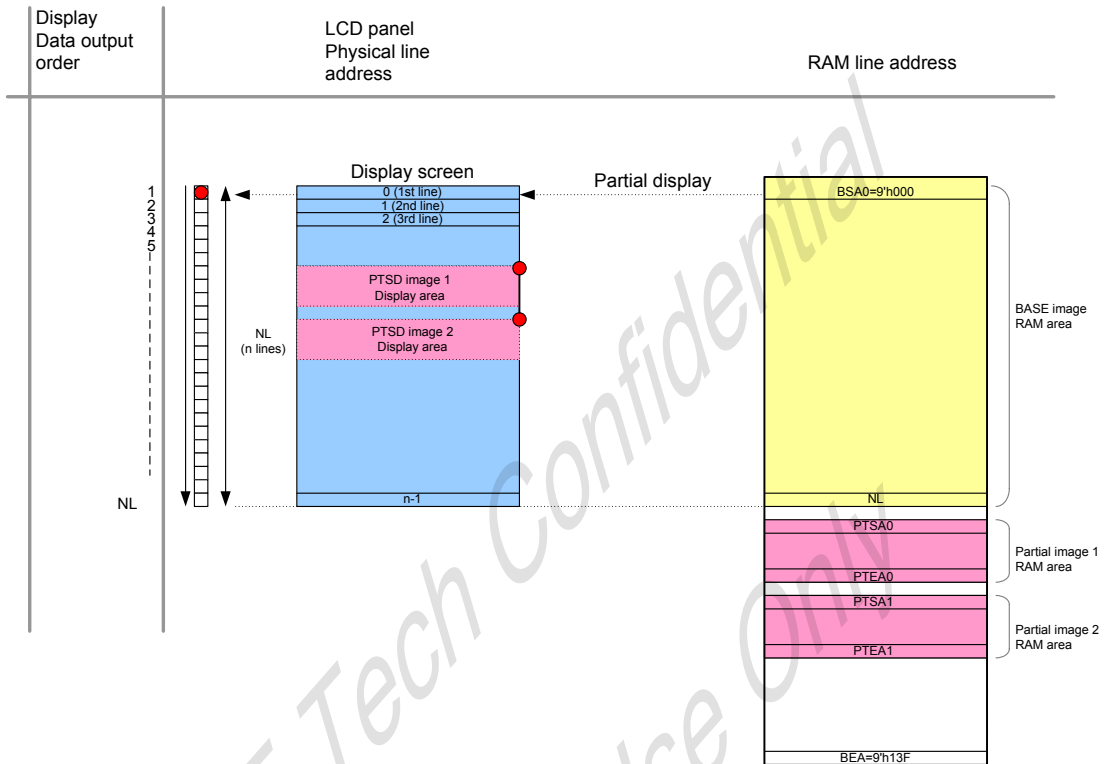


Figure 9-4 Example of NL[5:0] setting is < 6'h27 case

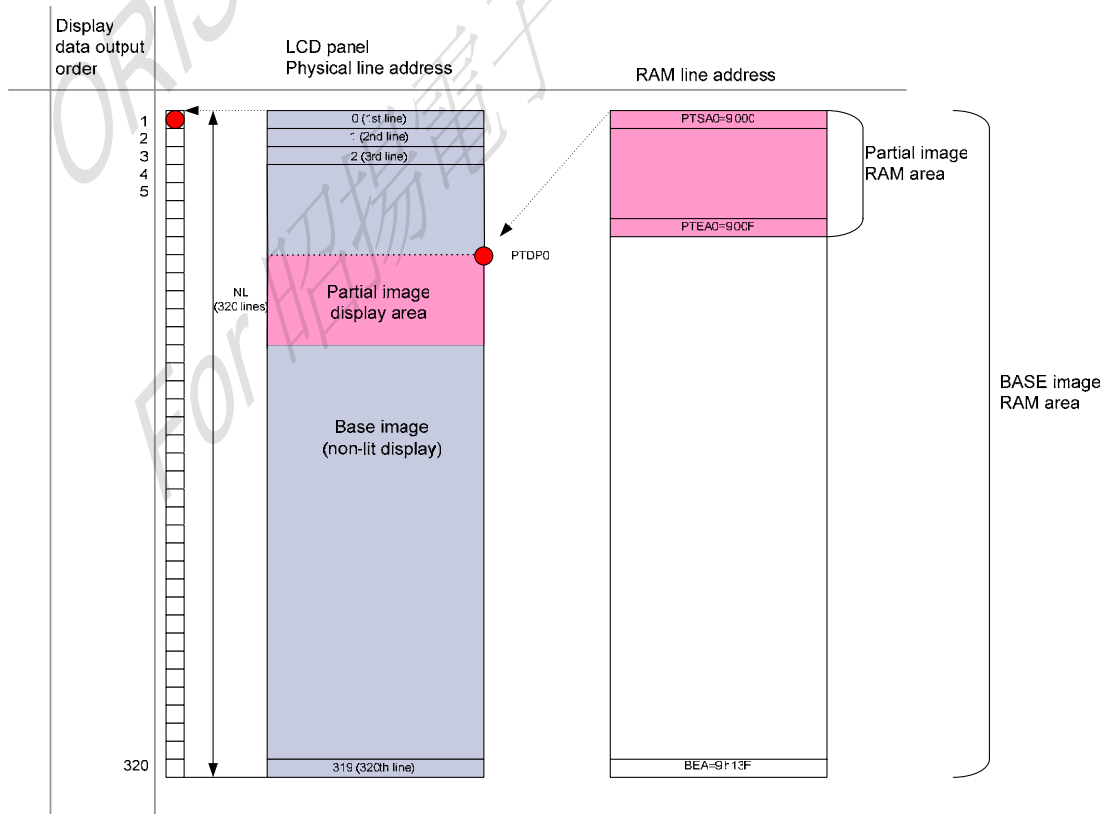


Figure 9-5 indicated the partial display area start position.

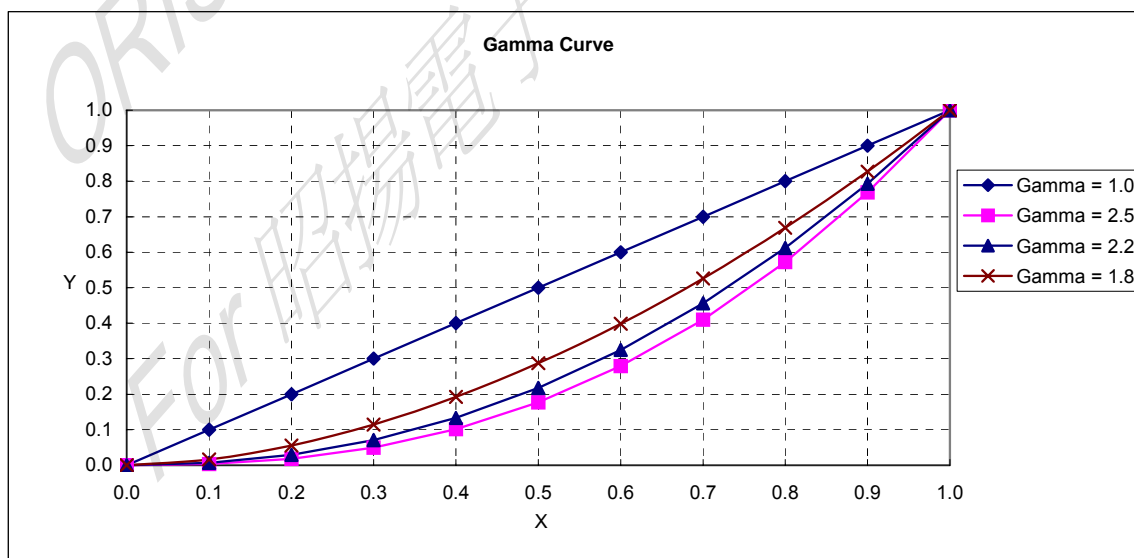
### 9.5. Gamma Correction functions:

SPFD54508B adopt Gamma voltage generation circuit which can provide wider output voltage range to fit the different kind of liquid crystal for Gamma curve from 1.0~2.5. The Gamma output voltage can be set by R30h~R3Fh.

V1RP[4:0]: register for positive VSD0 fine tune adjustment.  
V2RP[5:0]: register for positive VSD1 fine tune adjustment.  
V3RP[5:0]: register for positive VSD2 fine tune adjustment.  
V4RP[5:0]: register for positive VSD61 fine tune adjustment.  
V5RP[5:0]: register for positive VSD62 fine tune adjustment.  
V6RP[4:0]: register for positive VSD63 fine tune adjustment  
V7RP[4:0]: register for positive VSD13 fine tune adjustment  
V8RP[4:0]: register for positive VSD50 fine tune adjustment  
V9RP[3:0]: register for positive VSD4 fine tune adjustment  
V10RP[3:0]: register for positive VSD8 fine tune adjustment  
V11RP[3:0]: register for positive VSD20 fine tune adjustment  
V12RP[3:0]: register for positive VSD27 fine tune adjustment  
V13RP[3:0]: register for positive VSD36 fine tune adjustment  
V14RP[3:0]: register for positive VSD43 fine tune adjustment  
V15RP[3:0]: register for positive VSD55 fine tune adjustment  
V16RP[3:0]: register for positive VSD59 fine tune adjustment

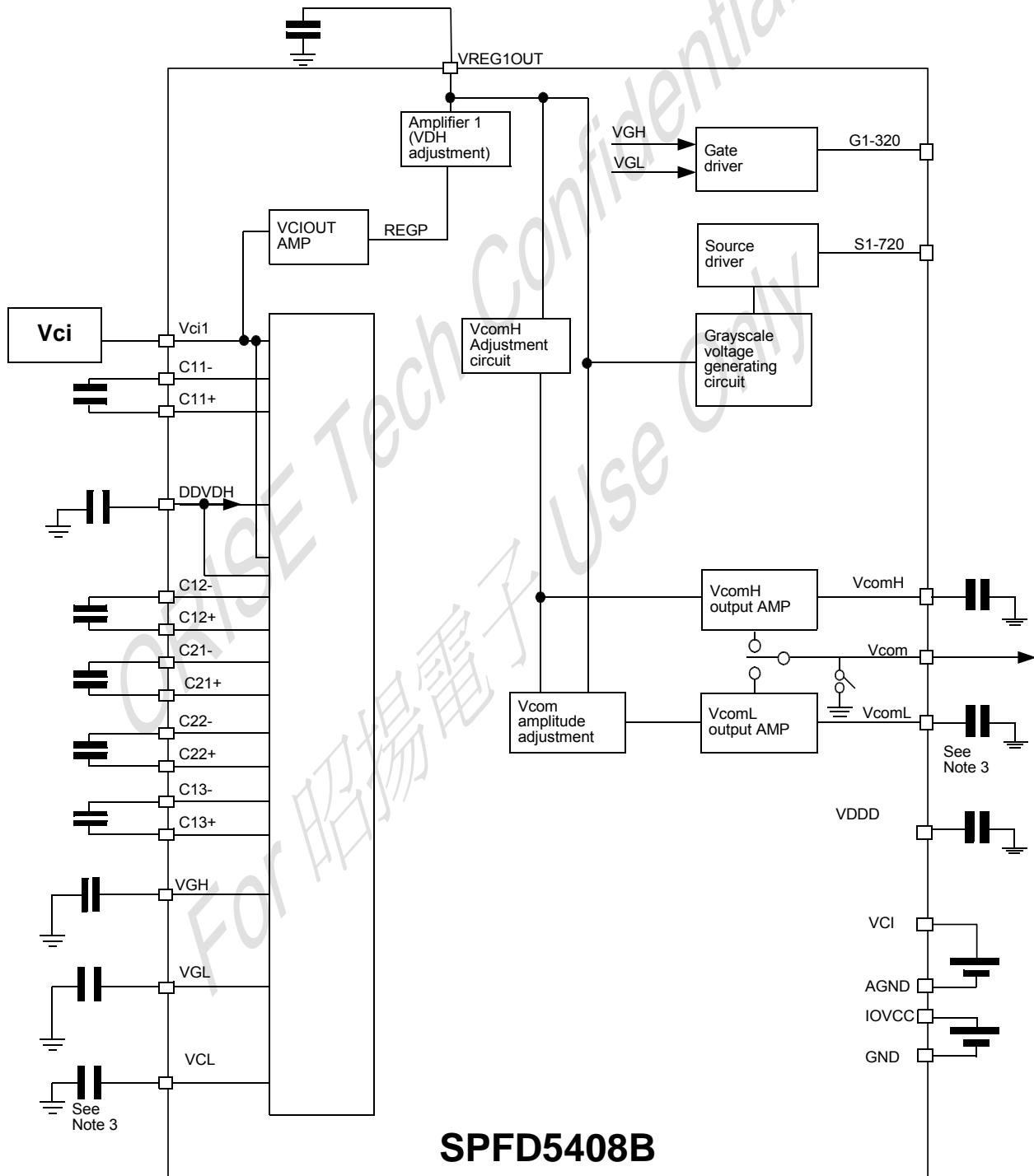
V1RN[4:0]: register for negative VSD0 fine tune adjustment.  
V2RN[5:0]: register for negative VSD1 fine tune adjustment.  
V3RN[5:0]: register for negative VSD2 fine tune adjustment.  
V4RN[5:0]: register for negative VSD61 fine tune adjustment.  
V5RN[5:0]: register for negative VSD62 fine tune adjustment.  
V6RN[4:0]: register for negative VSD63 fine tune adjustment  
V7RN[4:0]: register for negative VSD13 fine tune adjustment  
V8RN[4:0]: register for negative VSD50 fine tune adjustment  
V9RN[3:0]: register for negative VSD4 fine tune adjustment  
V10RN[3:0]: register for negative VSD8 fine tune adjustment  
V11RN[3:0]: register for negative VSD20 fine tune adjustment  
V12RN[3:0]: register for negative VSD27 fine tune adjustment  
V13RN[3:0]: register for negative VSD36 fine tune adjustment  
V14RN[3:0]: register for negative VSD43 fine tune adjustment  
V15RN[3:0]: register for negative VSD55 fine tune adjustment  
V16RN[3:0]: register for negative VSD59 fine tune adjustment

Figure 9-6 illustrated 4 different Gamma Curve.

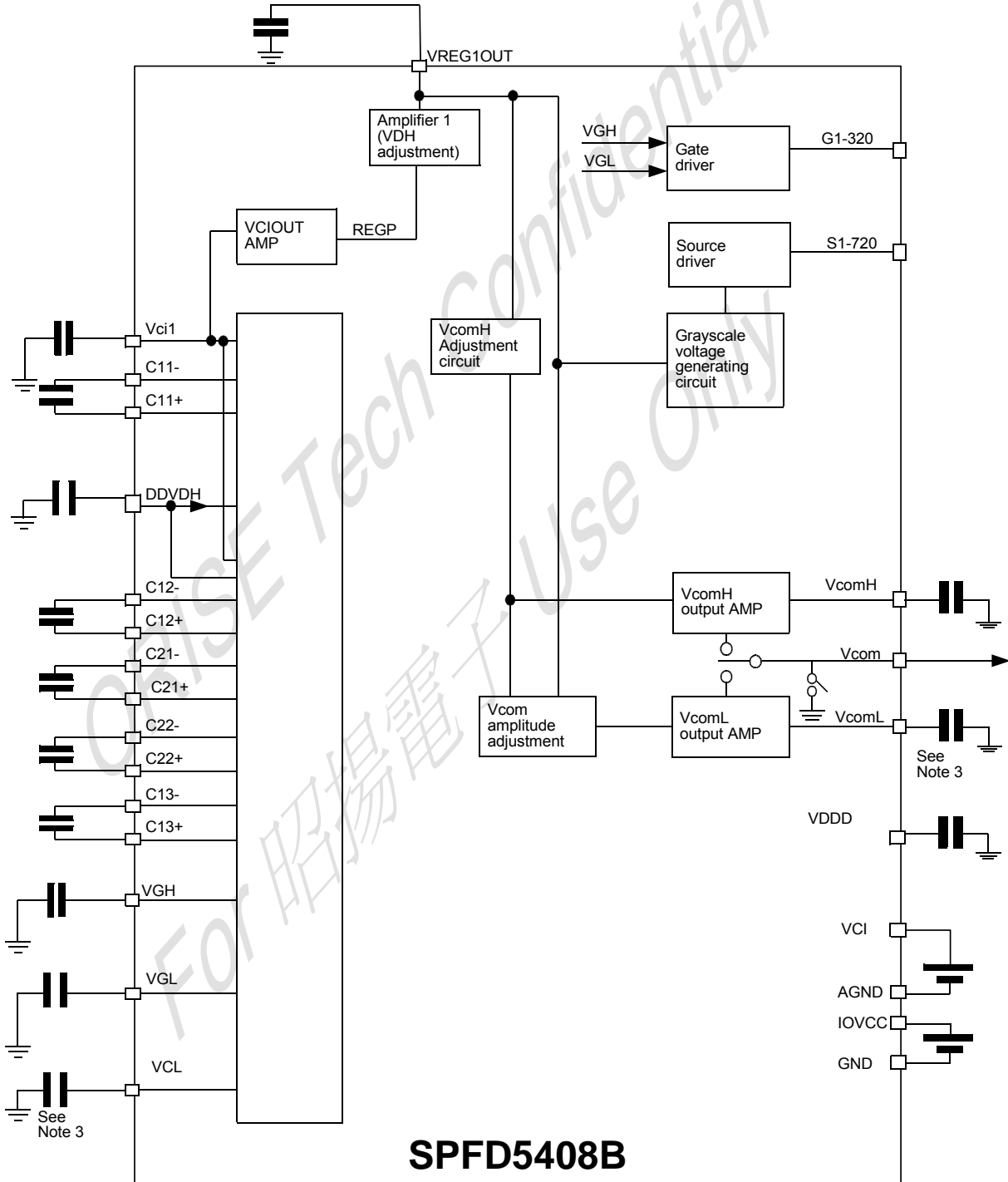


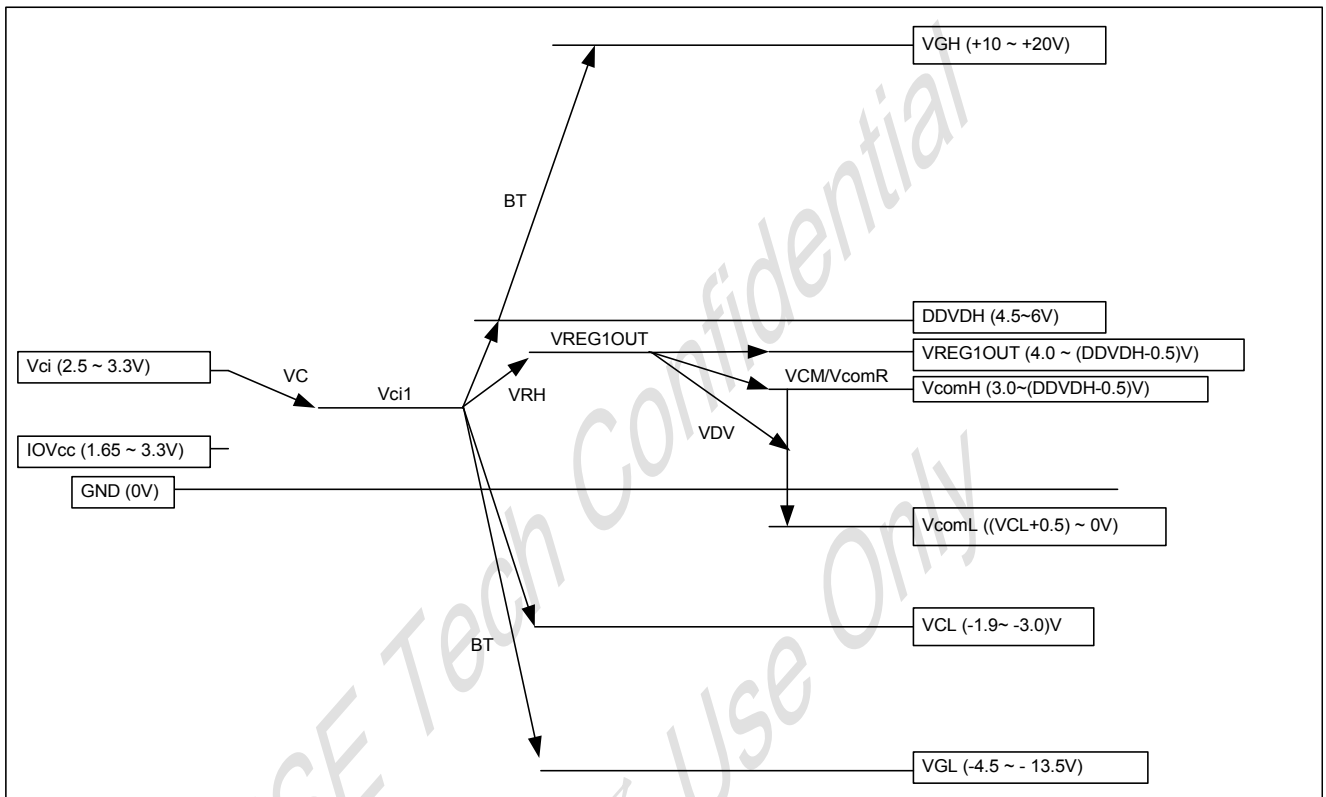
10. Power Management System:

(a) VCI short VCI1:

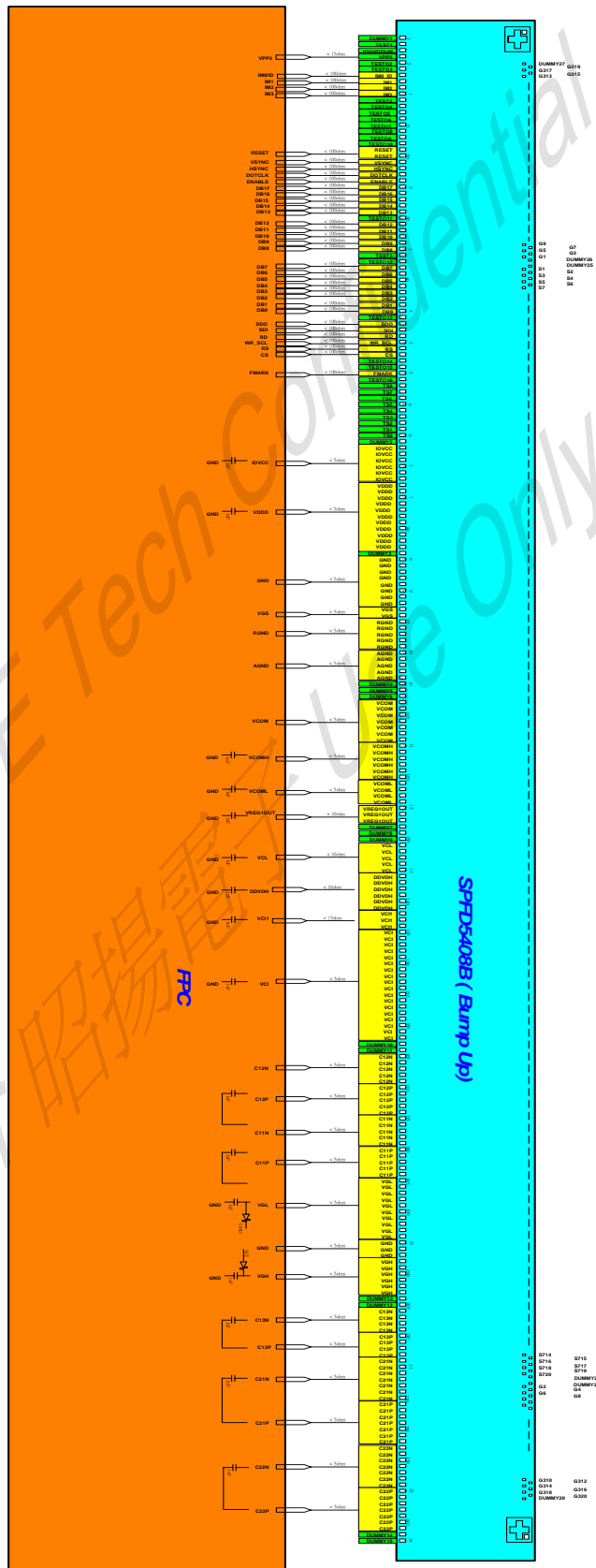


(b) Separate VCI and VCI1:





11. Application circuits:



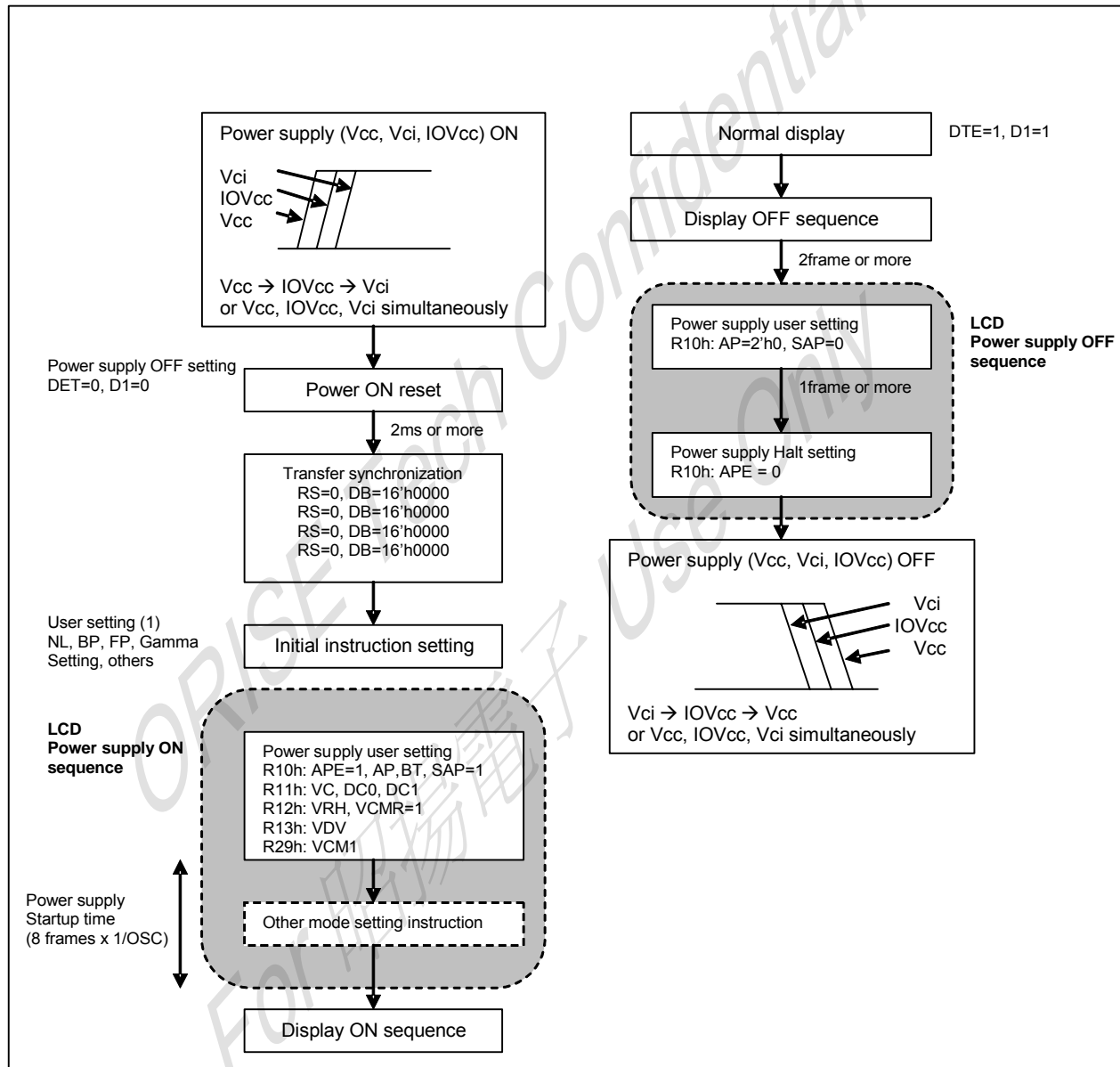
**12. Initial Code:**

Step	Register Address	Register Value	Note
1	R00h	TBD	
2	R01h	TBD	
3	R02h	TBD	
4	R03h	TBD	
5	R04h	TBD	
6	R08h	TBD	
7	R09h	TBD	
8	R0Ah	TBD	
9	R0Ch	TBD	
10	R0Dh	TBD	
11	R0Fh	TBD	
12	R07h	TBD	
13	R10h	TBD	
14	R11h	TBD	
15	R17h	TBD	
16	R12h	TBD	
17	R13h	TBD	
18	R29h	TBD	
19	R2Ah	TBD	
20	R50h	TBD	
21	R51h	TBD	
22	R52h	TBD	
23	R53h	TBD	
24	R60h	TBD	
25	R61h	TBD	
26	R6Ah	TBD	
27	R80h	TBD	
28	R81h	TBD	
29	R82h	TBD	
30	R83h	TBD	
31	R84h	TBD	
32	R85h	TBD	
33	R90h	TBD	
34	R92h	TBD	
35	R93h	TBD	
36	R95h	TBD	
37	R97h	TBD	
38	R98h	TBD	
39	R07h	TBD	

Note: This initial code is not including Gamma setting. Please contact Orise Technology for desired Gamma setting.

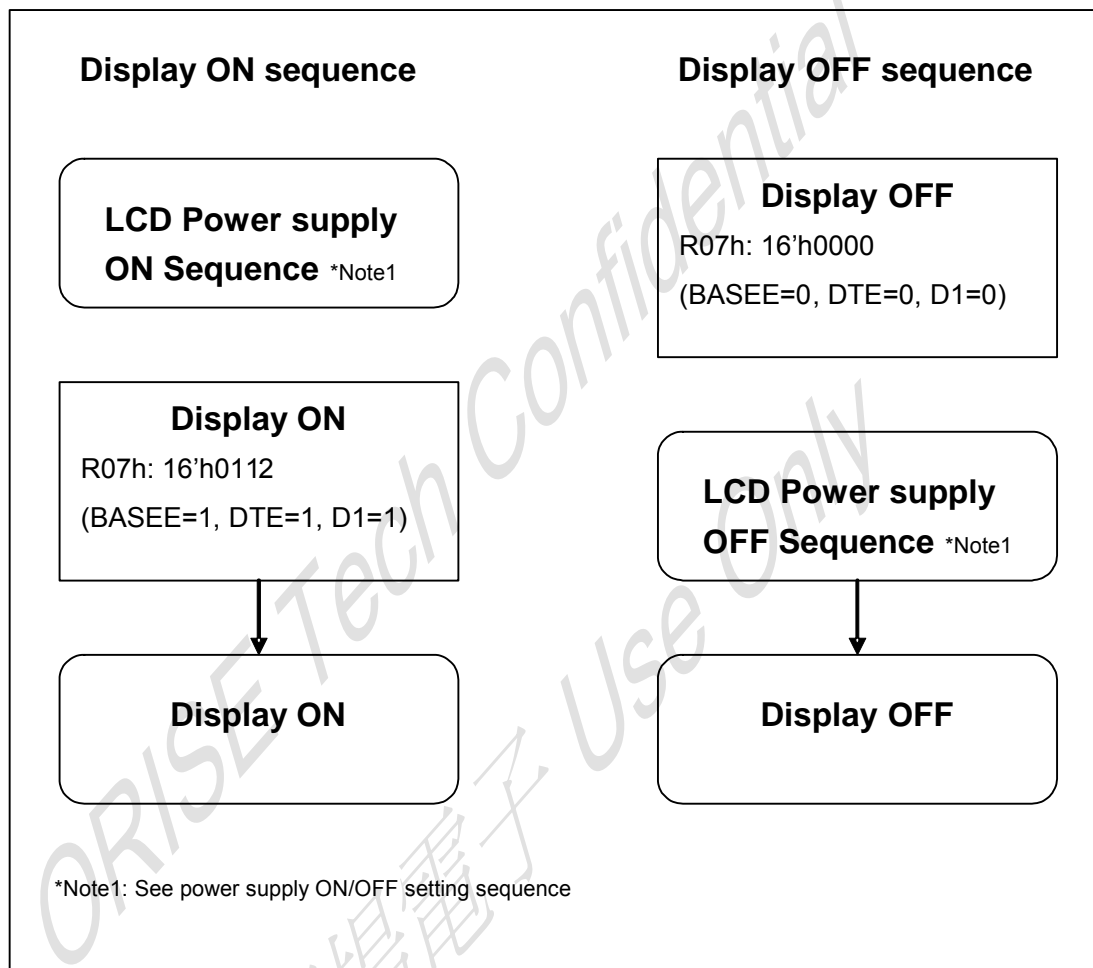
### 13. Power On/Off Sequence

#### 13.1. Power On/Off Sequence Diagram

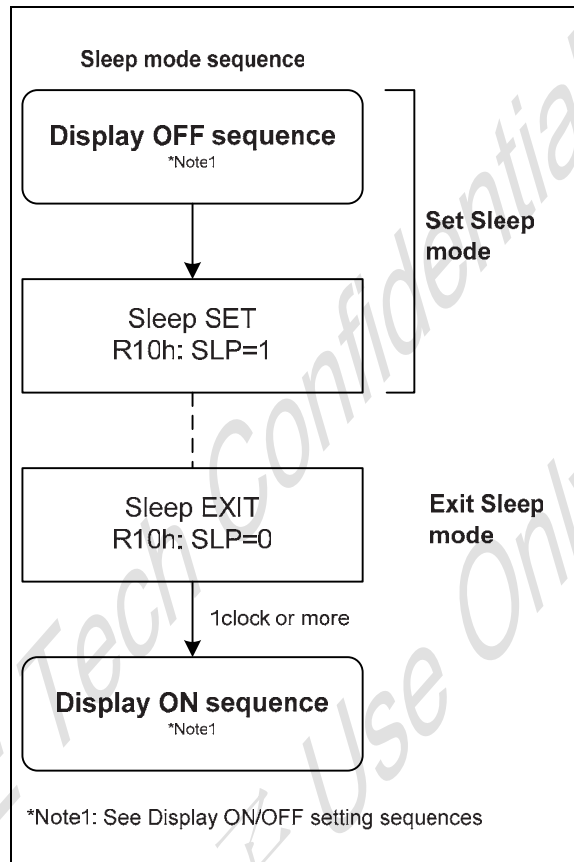




13.2. Display On/Off Sequence:



13.3. Sequence to exit sleep mode:



**14. Electrical Characteristics:**
**14.1. Absolute Maximum Ratings:**
**Table 14-1**

Item	Symbol	Unit	Value	Note
Power Supply Voltage1	VCC,IOVCC	V	-0.3 ~+4.6	
Power Supply Voltage 2	VCI – AGND	V	-0.3 ~+4.6	
Power Supply Voltage 3	DDVDH – AGND	V	-0.3 ~+6.5	
Power Supply Voltage4	AGND – VCL	V	-0.3 ~+4.6	
Power Supply Voltage 5	DDVDH – VCL	V	-0.3 ~+9.0	
Power Supply Voltage7	AGND – VGL	V	-0.3 ~+14.0	
Power Supply Voltage 8	VGH– VGL	V	-0.3 ~+30.0	
Input Voltage	Vt	V	-0.3 ~IOVCC + 0.3	
Operating Temperature	Topr	°C	-40 ~+85	
Storage Temperature	Tstg	°C	-55 ~+110	

**14.2. DC Characteristics**
**Table 14-2**

VCC= 2.50V~3.30V, IOVCC=1.65V~ 3.30V, Ta=-40°C~+85°C

Item	Symbol	Unit	Test Condition	Min.	Typ.	Max.	Note
Input High level voltage	VIH	V	IOVCC=1.65V~3.30V	0.8xIOVCC	-	IOVCC	
Input Low level voltage	VIL	V	IOVCC=1.65V~3.30V	-0.3	-	0.2xIOVCC	
Output "High" level voltage 1 (DB0-17)	VOH	V	IOVCC=1.65V~3.30V, IOH=-0.1mA	0.8xIOVCC	-	-	
Output "Low" level voltage 1 (DB0-17)	VOL	V	IOVCC=1.65V~3.30V, IOL=0.1mA	-	-	0.2xIOVCC	
I/O leak current	ILI	μA	Vin=0~IOVCC	-1	-	1	
Current Consumption Normal operation mode (262k-colors, display operation)	IOP1	μA	fosc= tdb kHz (320line drive), IOVCC=VCC=3.00V fFLM= tdb Hz Ta=25°C RAM data: 18'h000000	-	TBD	-	
Current Consumption 8-color mode, 64-line, partial display operation	IOP2	μA	fosc= tdb kHz (64-line, partial display), IOVCC=VCC=3.00V, fFLM= tdb Hz Ta=25°C RAM data: 18'h'000000	-	TBD	-	

### 14.3. AC Characteristics

VCC = 2.50V ~ 3.30V, IOVCC = 1.65V ~ 3.30V, Ta = -40°C ~ +85°C

#### 14.3.1. Clock Characteristics

Table 14-3

Item	Symbol	Unit	Timing Diagram	Min.	Typ.	Max.	Note
RC Oscillation clock	fosc	kHz	IOVCC = VCC = 3.0V, 25°C		TBD		9

#### 14.3.2. 80-System Bus Interface Timing Characteristics (18-/ 16- bit interface)

Table 14-4 Normal write operation, IOVCC = 1.65V ~ 3.30V

Item	Symbol	Unit	Min.	Typ.	Max.
Bus cycle time	Write	tCYCW	ns	125	-
	Read	tCYCR	ns	450	-
Write low-level pulse width	PWLW	ns	45	-	-
Read low-level pulse width	PWLR	ns	170	-	-
Write high-level pulse width	PWHW	ns	70	-	-
Read high-level pulse width	PWHR	ns	250	-	-
Write/Read rise/ fall time	tWRr, WRf	ns	-	-	25
Setup time	Write (RS to CS*, WR*)	tAS	ns	0	-
	Read (RS to CS*, RD*)		ns	10	-
Address Hold Time	tAH	ns	2	-	-
Write data setup time	tDSW	ns	25	-	-
Write data hold time	tH	ns	10	-	-
Read data delay time	tDDR	ns	-	-	150
Read data hold time	tDHR	ns	5	-	-

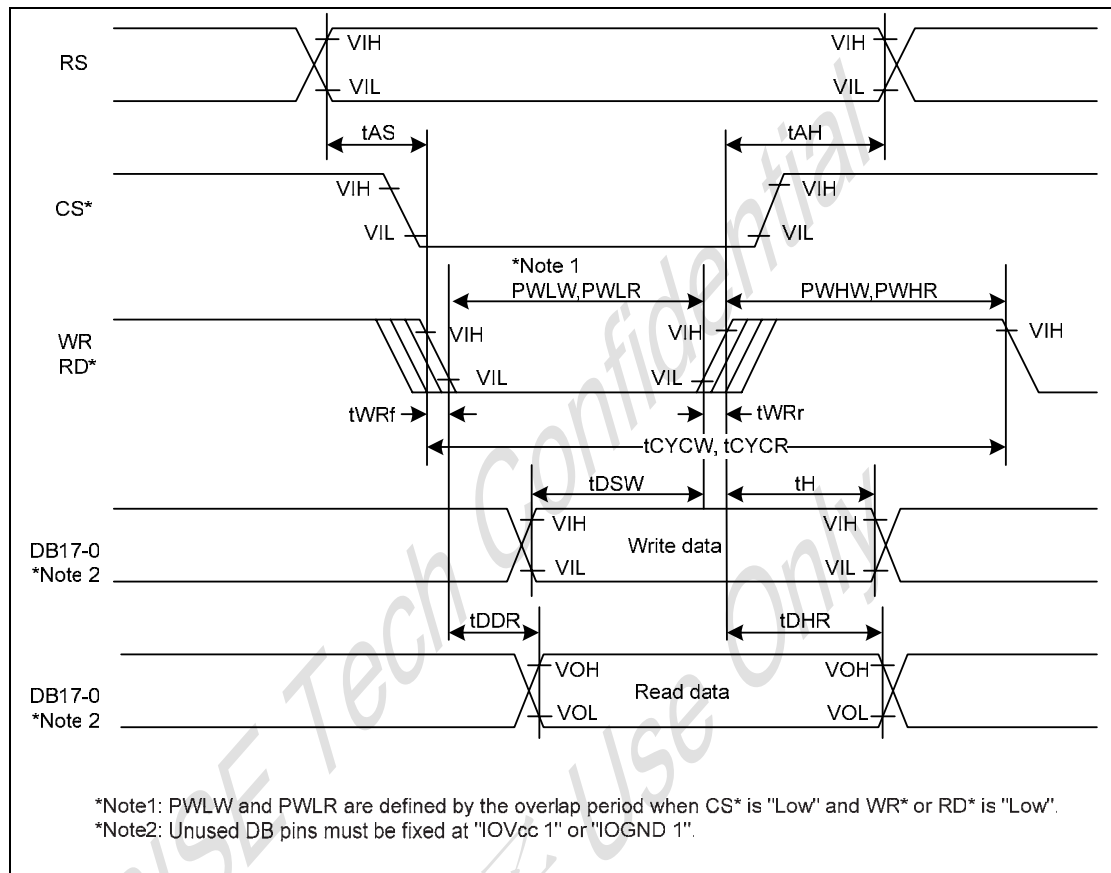


Figure 14-1 80-System Bus Interface

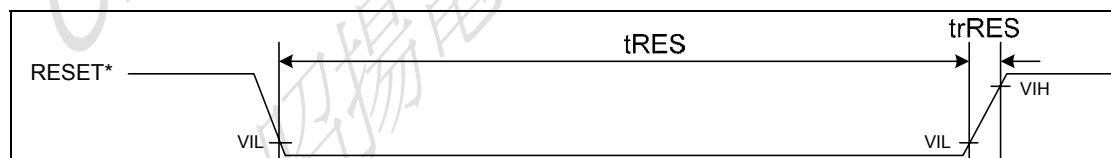


Figure 14-2 Reset Operation

**14.3.3. Clock-synchronized Serial Interface Timing Characteristics**
**Normal Write Function(IOVCC=1.65~3.30V)**
**Table 14-5**

Item	Symbol		Unit	Min.	Typ.	Max.
Serial Time Clock Cycle	Write (received)	tSCYC	ns	100	-	20.000
	Read (transmitted)	tSCYC	ns	350	-	20.000
Serial Clock high-level width	Write (received)	tSCH	ns	40	-	-
	Read (transmitted)	tSCH	ns	150	-	-
Serial Clock low-level width	Write (received)	tSCL	ns	40	-	-
	Read (transmitted)	tSCL	ns	150	-	-
Serial clock rise/fall time		tSCr, tSCf	ns	-	-	20
Chip select setup time		tCSU	ns	20	-	-
Chip select hold time		tCH	ns	60	-	-
Serial input data setup time		tSISU	ns	30	-	-
Serial input data hold time		tSIH	ns	30	-	-
Serial output data delay time		tSOD	ns	-	-	130
Serial output data hold time		tSOH	ns	5	-	-

**14.3.4. Reset Timing Characteristics (IOVCC=1.65~3.30V)**
**Table 14-6**

Item	Symbol	Unit	Min.	Typ.	Max.
Reset low-level width	tRES	ms	1	—	—
Reset rise time	trRES	μs	—	—	10

**14.3.5. RGB Interface Timing Characteristics**
**18-/ 16- bit RGB interface, IOVCC=1.65~3.30V**
**Table 14-7**

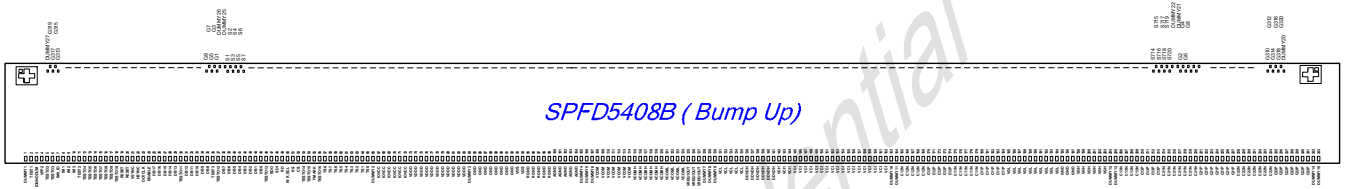
Item	Symbol	Unit	Min.	Typ.	Max.
VSYNC/HSYNC Setup time	TSYNCS	clock	0	-	1
ENABLE Setup time	TENS	ns	10	-	-
ENABLE Hold time	TENH	ns	20	-	-
DOTCLK low-level pulse width	PWDL	ns	40	-	-
DOTCLK high-level pulse width	PWDH	ns	40	-	-
DOTCLK cycle time	TCYCD	ns	100	-	-
Data setup time	TPDS	ns	10	-	-
Data hold time	TPDH	ns	40	-	-
DOTCLK, VSYNC and HSYNC rise/fall time	Trgbr Trgbf	ns	-	-	25

**6-bit RGB interface, IOVCC=1.65~3.30V**
**Table 14-8**

Item	Symbol	Unit	Min.	Typ.	Max.
VSYNC/HSYNC setup time	TSYNCS	clock	0	-	1
ENABLE setup time	TENS	ns	10	-	-
ENABLE hold time	TENH	ns	25	-	-
DOTCLK low-level pulse width	PWDL	ns	25	-	-
DOTCLK high-level pulse width	PWDH	ns	25	-	-
DOTCLK cycle time	TCYCD	ns	60	-	-
Data setup-time	TPDS	ns	10	-	-
Data hold time	TPDH	ns	25	-	-
DOTCLK, VSYNC, and HSYNC rise/fall time	Trgb Ttrgbf	ns	-	-	25

## 15. CHIP INFORMATION

### 15.1. PAD Assignment

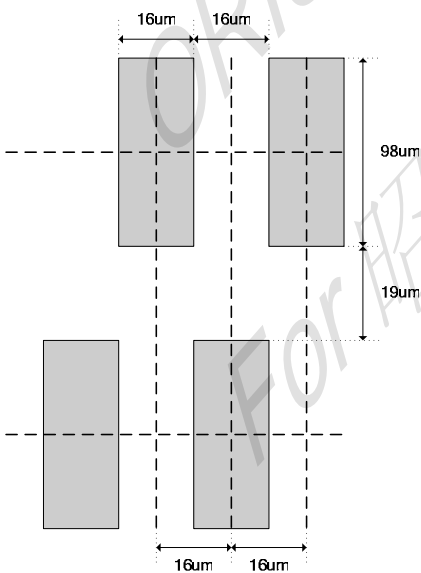


### 15.2. PAD Dimension

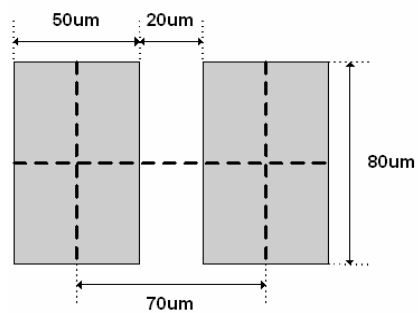
Item	PAD No.	Size		Unit
		X	Y	
Chip Size	-	17820	865	μm
Chip thickness	-	400 ± 25		
Pad pitch	1~243	70	-	
	244~1291	16	-	
Pad size	1~243	50	80	
	244~1291	16	98	

Note1: Chip size included scribe line.

#### 15.2.1. Output Pads



#### 15.2.2. Input Pads





### 15.3. Bump Characteristics

Item	Standard	Note
Bump Hardness	75Hv	± 25Hv
Bump Height	15µm	± 3µm
Co-planarity (in Chip)	$R \leq 2\mu\text{m}$	R : Max-Min
Roughness (in Bump)	$R \leq 2\mu\text{m}$	R : Max-Min
Bump Size	"X" ± 3µm x "Y" ± 3µm	X/Y: bump size
Shear Force	>4.5g/mil <sup>2</sup>	

ORISE Tech Confidential  
 For 昭揚電子 Use Only

**15.4. PAD Locations**

No.	Pad Name	X	Y
1	DUMMY1	-8610	-307.5
2	TEST1	-8540	-307.5
3	IOGNDDUM	-8470	-307.5
4	VPP2	-8400	-307.5
5	TESTO2	-8330	-307.5
6	TESTO3	-8260	-307.5
7	IM0_ID	-8190	-307.5
8	IM1	-8120	-307.5
9	IM2	-8050	-307.5
10	IM3	-7980	-307.5
11	TEST2	-7910	-307.5
12	TESTO4	-7840	-307.5
13	TESTO5	-7770	-307.5
14	TESTO6	-7700	-307.5
15	TESTO7	-7630	-307.5
16	TESTO8	-7560	-307.5
17	TESTO9	-7490	-307.5
18	TESTO10	-7420	-307.5
19	RESET	-7350	-307.5
20	RESET	-7280	-307.5
21	VSYNC	-7210	-307.5
22	HSYNC	-7140	-307.5
23	DOTCLK	-7070	-307.5
24	ENABLE	-7000	-307.5
25	DB17	-6905	-307.5
26	DB16	-6825	-307.5
27	DB15	-6745	-307.5
28	DB14	-6665	-307.5
29	DB13	-6585	-307.5
30	TESTO11	-6495	-307.5
31	DB12	-6405	-307.5
32	DB11	-6325	-307.5
33	DB10	-6245	-307.5
34	DB9	-6165	-307.5
35	DB8	-6085	-307.5
36	TEST3	-5990	-307.5
37	TESTO12	-5920	-307.5
38	DB7	-5825	-307.5
39	DB6	-5745	-307.5
40	DB5	-5665	-307.5
41	DB4	-5585	-307.5
42	DB3	-5505	-307.5
43	DB2	-5425	-307.5
44	DB1	-5345	-307.5
45	DB0	-5265	-307.5
46	TESTO13	-5180	-307.5
47	SDO	-5110	-307.5
48	SDI	-5040	-307.5
49	RD	-4970	-307.5
50	WR_SCL	-4900	-307.5
51	RS	-4830	-307.5
52	CS	-4760	-307.5
53	TESTO14	-4690	-307.5

No.	Pad Name	X	Y
54	TESTO15	-4620	-307.5
55	FMARK	-4550	-307.5
56	TESTO16	-4480	-307.5
57	TS8	-4410	-307.5
58	TS7	-4340	-307.5
59	TS6	-4270	-307.5
60	TS5	-4200	-307.5
61	TS4	-4130	-307.5
62	TS3	-4060	-307.5
63	TS2	-3990	-307.5
64	TS1	-3920	-307.5
65	TS0	-3850	-307.5
66	DUMMY2	-3780	-307.5
67	IOVCC	-3710	-307.5
68	IOVCC	-3640	-307.5
69	IOVCC	-3570	-307.5
70	IOVCC	-3500	-307.5
71	IOVCC	-3430	-307.5
72	IOVCC	-3360	-307.5
73	VDDD	-3290	-307.5
74	VDDD	-3220	-307.5
75	VDDD	-3150	-307.5
76	VDDD	-3080	-307.5
77	VDDD	-3010	-307.5
78	VDDD	-2940	-307.5
79	VDDD	-2870	-307.5
80	VDDD	-2800	-307.5
81	VDDD	-2730	-307.5
82	VDDD	-2660	-307.5
83	VDDD	-2590	-307.5
84	DUMMY3	-2520	-307.5
85	GND	-2450	-307.5
86	GND	-2380	-307.5
87	GND	-2310	-307.5
88	GND	-2240	-307.5
89	GND	-2170	-307.5
90	GND	-2100	-307.5
91	GND	-2030	-307.5
92	GND	-1960	-307.5
93	VGS	-1890	-307.5
94	VGS	-1820	-307.5
95	RGND	-1750	-307.5
96	RGND	-1680	-307.5
97	RGND	-1610	-307.5
98	RGND	-1540	-307.5
99	RGND	-1470	-307.5
100	AGND	-1400	-307.5
101	AGND	-1330	-307.5
102	AGND	-1260	-307.5
103	AGND	-1190	-307.5
104	AGND	-1120	-307.5
105	DUMMY4	-1050	-307.5
106	DUMMY5	-980	-307.5

No.	Pad Name	X	Y
107	DUMMY6	-910	-307.5
108	VCOM	-840	-307.5
109	VCOM	-770	-307.5
110	VCOM	-700	-307.5
111	VCOM	-630	-307.5
112	VCOM	-560	-307.5
113	VCOM	-490	-307.5
114	VCOM	-420	-307.5
115	VCOMH	-350	-307.5
116	VCOMH	-280	-307.5
117	VCOMH	-210	-307.5
118	VCOMH	-140	-307.5
119	VCOMH	-70	-307.5
120	VCOMH	0	-307.5
121	VCOML	70	-307.5
122	VCOML	140	-307.5
123	VCOML	210	-307.5
124	VCOML	280	-307.5
125	VREG1OUT	350	-307.5
126	VREG1OUT	420	-307.5
127	VREG1OUT	490	-307.5
128	DUMMY7	560	-307.5
129	DUMMY8	630	-307.5
130	DUMMY9	700	-307.5
131	VCL	770	-307.5
132	VCL	840	-307.5
133	VCL	910	-307.5
134	VCL	980	-307.5
135	VCL	1050	-307.5
136	DDVDH	1120	-307.5
137	DDVDH	1190	-307.5
138	DDVDH	1260	-307.5
139	DDVDH	1330	-307.5
140	DDVDH	1400	-307.5
141	DDVDH	1470	-307.5
142	VCI1	1540	-307.5
143	VCI1	1610	-307.5
144	VCI1	1680	-307.5
145	VCI	1750	-307.5
146	VCI	1820	-307.5
147	VCI	1890	-307.5
148	VCI	1960	-307.5
149	VCI	2030	-307.5
150	VCI	2100	-307.5
151	VCI	2170	-307.5
152	VCI	2240	-307.5
153	VCI	2310	-307.5
154	VCI	2380	-307.5
155	VCI	2450	-307.5
156	VCI	2520	-307.5
157	VCI	2590	-307.5
158	VCI	2660	-307.5
159	VCI	2730	-307.5

No.	Pad Name	X	Y
160	VCI	2800	-307.5
161	VCI	2870	-307.5
162	VCI	2940	-307.5
163	DUMMY10	3010	-307.5
164	DUMMY11	3080	-307.5
165	C12N	3150	-307.5
166	C12N	3220	-307.5
167	C12N	3290	-307.5
168	C12N	3360	-307.5
169	C12N	3430	-307.5
170	C12P	3500	-307.5
171	C12P	3570	-307.5
172	C12P	3640	-307.5
173	C12P	3710	-307.5
174	C12P	3780	-307.5
175	C11N	3850	-307.5
176	C11N	3920	-307.5
177	C11N	3990	-307.5
178	C11N	4060	-307.5
179	C11N	4130	-307.5
180	C11P	4200	-307.5
181	C11P	4270	-307.5
182	C11P	4340	-307.5
183	C11P	4410	-307.5
184	C11P	4480	-307.5
185	VGL	4550	-307.5
186	VGL	4620	-307.5
187	VGL	4690	-307.5
188	VGL	4760	-307.5
189	VGL	4830	-307.5
190	VGL	4900	-307.5
191	VGL	4970	-307.5
192	VGL	5040	-307.5
193	VGL	5110	-307.5
194	VGL	5180	-307.5
195	GND	5250	-307.5
196	GND	5320	-307.5
197	GND	5390	-307.5
198	VGH	5460	-307.5
199	VGH	5530	-307.5
200	VGH	5600	-307.5
201	VGH	5670	-307.5
202	VGH	5740	-307.5
203	VGH	5810	-307.5
204	DUMMY12	5880	-307.5
205	DUMMY13	5950	-307.5
206	C13N	6020	-307.5
207	C13N	6090	-307.5
208	C13N	6160	-307.5
209	C13N	6230	-307.5
210	C13P	6300	-307.5
211	C13P	6370	-307.5
212	C13P	6440	-307.5
213	C13P	6510	-307.5
214	C21N	6580	-307.5

No.	Pad Name	X	Y
215	C21N	6650	-307.5
216	C21N	6720	-307.5
217	C21N	6790	-307.5
218	C21N	6860	-307.5
219	C21N	6930	-307.5
220	C21N	7000	-307.5
221	C21P	7070	-307.5
222	C21P	7140	-307.5
223	C21P	7210	-307.5
224	C21P	7280	-307.5
225	C21P	7350	-307.5
226	C21P	7420	-307.5
227	C21P	7490	-307.5
228	C22N	7560	-307.5
229	C22N	7630	-307.5
230	C22N	7700	-307.5
231	C22N	7770	-307.5
232	C22N	7840	-307.5
233	C22N	7910	-307.5
234	C22N	7980	-307.5
235	C22P	8050	-307.5
236	C22P	8120	-307.5
237	C22P	8190	-307.5
238	C22P	8260	-307.5
239	C22P	8330	-307.5
240	C22P	8400	-307.5
241	C22P	8470	-307.5
242	DUMMY14	8540	-307.5
243	DUMMY15	8610	-307.5
244	DUMMY20	8659	202.5
245	G320	8643	319.5
246	G318	8627	202.5
247	G316	8611	319.5
248	G314	8595	202.5
249	G312	8579	319.5
250	G310	8563	202.5
251	G308	8547	319.5
252	G306	8531	202.5
253	G304	8515	319.5
254	G302	8499	202.5
255	G300	8483	319.5
256	G298	8467	202.5
257	G296	8451	319.5
258	G294	8435	202.5
259	G292	8419	319.5
260	G290	8403	202.5
261	G288	8387	319.5
262	G286	8371	202.5
263	G284	8355	319.5
264	G282	8339	202.5
265	G280	8323	319.5
266	G278	8307	202.5
267	G276	8291	319.5
268	G274	8275	202.5
269	G272	8259	319.5

No.	Pad Name	X	Y
270	G270	8243	202.5
271	G268	8227	319.5
272	G266	8211	202.5
273	G264	8195	319.5
274	G262	8179	202.5
275	G260	8163	319.5
276	G258	8147	202.5
277	G256	8131	319.5
278	G254	8115	202.5
279	G252	8099	319.5
280	G250	8083	202.5
281	G248	8067	319.5
282	G246	8051	202.5
283	G244	8035	319.5
284	G242	8019	202.5
285	G240	8003	319.5
286	G238	7987	202.5
287	G236	7971	319.5
288	G234	7955	202.5
289	G232	7939	319.5
290	G230	7923	202.5
291	G228	7907	319.5
292	G226	7891	202.5
293	G224	7875	319.5
294	G222	7859	202.5
295	G220	7843	319.5
296	G218	7827	202.5
297	G216	7811	319.5
298	G214	7795	202.5
299	G212	7779	319.5
300	G210	7763	202.5
301	G208	7747	319.5
302	G206	7731	202.5
303	G204	7715	319.5
304	G202	7699	202.5
305	G200	7683	319.5
306	G198	7667	202.5
307	G196	7651	319.5
308	G194	7635	202.5
309	G192	7619	319.5
310	G190	7603	202.5
311	G188	7587	319.5
312	G186	7571	202.5
313	G184	7555	319.5
314	G182	7539	202.5
315	G180	7523	319.5
316	G178	7507	202.5
317	G176	7491	319.5
318	G174	7475	202.5
319	G172	7459	319.5
320	G170	7443	202.5
321	G168	7427	319.5
322	G166	7411	202.5
323	G164	7395	319.5
324	G162	7379	202.5



No.	Pad Name	X	Y
325	G160	7363	319.5
326	G158	7347	202.5
327	G156	7331	319.5
328	G154	7315	202.5
329	G152	7299	319.5
330	G150	7283	202.5
331	G148	7267	319.5
332	G146	7251	202.5
333	G144	7235	319.5
334	G142	7219	202.5
335	G140	7203	319.5
336	G138	7187	202.5
337	G136	7171	319.5
338	G134	7155	202.5
339	G132	7139	319.5
340	G130	7123	202.5
341	G128	7107	319.5
342	G126	7091	202.5
343	G124	7075	319.5
344	G122	7059	202.5
345	G120	7043	319.5
346	G118	7027	202.5
347	G116	7011	319.5
348	G114	6995	202.5
349	G112	6979	319.5
350	G110	6963	202.5
351	G108	6947	319.5
352	G106	6931	202.5
353	G104	6915	319.5
354	G102	6899	202.5
355	G100	6883	319.5
356	G98	6867	202.5
357	G96	6851	319.5
358	G94	6835	202.5
359	G92	6819	319.5
360	G90	6803	202.5
361	G88	6787	319.5
362	G86	6771	202.5
363	G84	6755	319.5
364	G82	6739	202.5
365	G80	6723	319.5
366	G78	6707	202.5
367	G76	6691	319.5
368	G74	6675	202.5
369	G72	6659	319.5
370	G70	6643	202.5
371	G68	6627	319.5
372	G66	6611	202.5
373	G64	6595	319.5
374	G62	6579	202.5
375	G60	6563	319.5
376	G58	6547	202.5
377	G56	6531	319.5
378	G54	6515	202.5
379	G52	6499	319.5

No.	Pad Name	X	Y
380	G50	6483	202.5
381	G48	6467	319.5
382	G46	6451	202.5
383	G44	6435	319.5
384	G42	6419	202.5
385	G40	6403	319.5
386	G38	6387	202.5
387	G36	6371	319.5
388	G34	6355	202.5
389	G32	6339	319.5
390	G30	6323	202.5
391	G28	6307	319.5
392	G26	6291	202.5
393	G24	6275	319.5
394	G22	6259	202.5
395	G20	6243	319.5
396	G18	6227	202.5
397	G16	6211	319.5
398	G14	6195	202.5
399	G12	6179	319.5
400	G10	6163	202.5
401	G8	6147	319.5
402	G6	6131	202.5
403	G4	6115	319.5
404	G2	6099	202.5
405	DUMMY21	6083	319.5
406	DUMMY22	6047	319.5
407	S720	6031	202.5
408	S719	6015	319.5
409	S718	5999	202.5
410	S717	5983	319.5
411	S716	5967	202.5
412	S715	5951	319.5
413	S714	5935	202.5
414	S713	5919	319.5
415	S712	5903	202.5
416	S711	5887	319.5
417	S710	5871	202.5
418	S709	5855	319.5
419	S708	5839	202.5
420	S707	5823	319.5
421	S706	5807	202.5
422	S705	5791	319.5
423	S704	5775	202.5
424	S703	5759	319.5
425	S702	5743	202.5
426	S701	5727	319.5
427	S700	5711	202.5
428	S699	5695	319.5
429	S698	5679	202.5
430	S697	5663	319.5
431	S696	5647	202.5
432	S695	5631	319.5
433	S694	5615	202.5
434	S693	5599	319.5

No.	Pad Name	X	Y
435	S692	5583	202.5
436	S691	5567	319.5
437	S690	5551	202.5
438	S689	5535	319.5
439	S688	5519	202.5
440	S687	5503	319.5
441	S686	5487	202.5
442	S685	5471	319.5
443	S684	5455	202.5
444	S683	5439	319.5
445	S682	5423	202.5
446	S681	5407	319.5
447	S680	5391	202.5
448	S679	5375	319.5
449	S678	5359	202.5
450	S677	5343	319.5
451	S676	5327	202.5
452	S675	5311	319.5
453	S674	5295	202.5
454	S673	5279	319.5
455	S672	5263	202.5
456	S671	5247	319.5
457	S670	5231	202.5
458	S669	5215	319.5
459	S668	5199	202.5
460	S667	5183	319.5
461	S666	5167	202.5
462	S665	5151	319.5
463	S664	5135	202.5
464	S663	5119	319.5
465	S662	5103	202.5
466	S661	5087	319.5
467	S660	5071	202.5
468	S659	5055	319.5
469	S658	5039	202.5
470	S657	5023	319.5
471	S656	5007	202.5
472	S655	4991	319.5
473	S654	4975	202.5
474	S653	4959	319.5
475	S652	4943	202.5
476	S651	4927	319.5
477	S650	4911	202.5
478	S649	4895	319.5
479	S648	4879	202.5
480	S647	4863	319.5
481	S646	4847	202.5
482	S645	4831	319.5
483	S644	4815	202.5
484	S643	4799	319.5
485	S642	4783	202.5
486	S641	4767	319.5
487	S640	4751	202.5
488	S639	4735	319.5
489	S638	4719	202.5

No.	Pad Name	X	Y
490	S637	4703	319.5
491	S636	4687	202.5
492	S635	4671	319.5
493	S634	4655	202.5
494	S633	4639	319.5
495	S632	4623	202.5
496	S631	4607	319.5
497	S630	4591	202.5
498	S629	4575	319.5
499	S628	4559	202.5
500	S627	4543	319.5
501	S626	4527	202.5
502	S625	4511	319.5
503	S624	4495	202.5
504	S623	4479	319.5
505	S622	4463	202.5
506	S621	4447	319.5
507	S620	4431	202.5
508	S619	4415	319.5
509	S618	4399	202.5
510	S617	4383	319.5
511	S616	4367	202.5
512	S615	4351	319.5
513	S614	4335	202.5
514	S613	4319	319.5
515	S612	4303	202.5
516	S611	4287	319.5
517	S610	4271	202.5
518	S609	4255	319.5
519	S608	4239	202.5
520	S607	4223	319.5
521	S606	4207	202.5
522	S605	4191	319.5
523	S604	4175	202.5
524	S603	4159	319.5
525	S602	4143	202.5
526	S601	4127	319.5
527	S600	4111	202.5
528	S599	4095	319.5
529	S598	4079	202.5
530	S597	4063	319.5
531	S596	4047	202.5
532	S595	4031	319.5
533	S594	4015	202.5
534	S593	3999	319.5
535	S592	3983	202.5
536	S591	3967	319.5
537	S590	3951	202.5
538	S589	3935	319.5
539	S588	3919	202.5
540	S587	3903	319.5
541	S586	3887	202.5
542	S585	3871	319.5
543	S584	3855	202.5
544	S583	3839	319.5

No.	Pad Name	X	Y
545	S582	3823	202.5
546	S581	3807	319.5
547	S580	3791	202.5
548	S579	3775	319.5
549	S578	3759	202.5
550	S577	3743	319.5
551	S576	3727	202.5
552	S575	3711	319.5
553	S574	3695	202.5
554	S573	3679	319.5
555	S572	3663	202.5
556	S571	3647	319.5
557	S570	3631	202.5
558	S569	3615	319.5
559	S568	3599	202.5
560	S567	3583	319.5
561	S566	3567	202.5
562	S565	3551	319.5
563	S564	3535	202.5
564	S563	3519	319.5
565	S562	3503	202.5
566	S561	3487	319.5
567	S560	3471	202.5
568	S559	3455	319.5
569	S558	3439	202.5
570	S557	3423	319.5
571	S556	3407	202.5
572	S555	3391	319.5
573	S554	3375	202.5
574	S553	3359	319.5
575	S552	3343	202.5
576	S551	3327	319.5
577	S550	3311	202.5
578	S549	3295	319.5
579	S548	3279	202.5
580	S547	3263	319.5
581	S546	3247	202.5
582	S545	3231	319.5
583	S544	3215	202.5
584	S543	3199	319.5
585	S542	3183	202.5
586	S541	3167	319.5
587	S540	3151	202.5
588	S539	3135	319.5
589	S538	3119	202.5
590	S537	3103	319.5
591	S536	3087	202.5
592	S535	3071	319.5
593	S534	3055	202.5
594	S533	3039	319.5
595	S532	3023	202.5
596	S531	3007	319.5
597	S530	2991	202.5
598	S529	2975	319.5
599	S528	2959	202.5

No.	Pad Name	X	Y
600	S527	2943	319.5
601	S526	2927	202.5
602	S525	2911	319.5
603	S524	2895	202.5
604	S523	2879	319.5
605	S522	2863	202.5
606	S521	2847	319.5
607	S520	2831	202.5
608	S519	2815	319.5
609	S518	2799	202.5
610	S517	2783	319.5
611	S516	2767	202.5
612	S515	2751	319.5
613	S514	2735	202.5
614	S513	2719	319.5
615	S512	2703	202.5
616	S511	2687	319.5
617	S510	2671	202.5
618	S509	2655	319.5
619	S508	2639	202.5
620	S507	2623	319.5
621	S506	2607	202.5
622	S505	2591	319.5
623	S504	2575	202.5
624	S503	2559	319.5
625	S502	2543	202.5
626	S501	2527	319.5
627	S500	2511	202.5
628	S499	2495	319.5
629	S498	2479	202.5
630	S497	2463	319.5
631	S496	2447	202.5
632	S495	2431	319.5
633	S494	2415	202.5
634	S493	2399	319.5
635	S492	2383	202.5
636	S491	2367	319.5
637	S490	2351	202.5
638	S489	2335	319.5
639	S488	2319	202.5
640	S487	2303	319.5
641	S486	2287	202.5
642	S485	2271	319.5
643	S484	2255	202.5
644	S483	2239	319.5
645	S482	2223	202.5
646	S481	2207	319.5
647	S480	2191	202.5
648	S479	2175	319.5
649	S478	2159	202.5
650	S477	2143	319.5
651	S476	2127	202.5
652	S475	2111	319.5
653	S474	2095	202.5
654	S473	2079	319.5



No.	Pad Name	X	Y
655	S472	2063	202.5
656	S471	2047	319.5
657	S470	2031	202.5
658	S469	2015	319.5
659	S468	1999	202.5
660	S467	1983	319.5
661	S466	1967	202.5
662	S465	1951	319.5
663	S464	1935	202.5
664	S463	1919	319.5
665	S462	1903	202.5
666	S461	1887	319.5
667	S460	1871	202.5
668	S459	1855	319.5
669	S458	1839	202.5
670	S457	1823	319.5
671	S456	1807	202.5
672	S455	1791	319.5
673	S454	1775	202.5
674	S453	1759	319.5
675	S452	1743	202.5
676	S451	1727	319.5
677	S450	1711	202.5
678	S449	1695	319.5
679	S448	1679	202.5
680	S447	1663	319.5
681	S446	1647	202.5
682	S445	1631	319.5
683	S444	1615	202.5
684	S443	1599	319.5
685	S442	1583	202.5
686	S441	1567	319.5
687	S440	1551	202.5
688	S439	1535	319.5
689	S438	1519	202.5
690	S437	1503	319.5
691	S436	1487	202.5
692	S435	1471	319.5
693	S434	1455	202.5
694	S433	1439	319.5
695	S432	1423	202.5
696	S431	1407	319.5
697	S430	1391	202.5
698	S429	1375	319.5
699	S428	1359	202.5
700	S427	1343	319.5
701	S426	1327	202.5
702	S425	1311	319.5
703	S424	1295	202.5
704	S423	1279	319.5
705	S422	1263	202.5
706	S421	1247	319.5
707	S420	1231	202.5
708	S419	1215	319.5
709	S418	1199	202.5

No.	Pad Name	X	Y
710	S417	1183	319.5
711	S416	1167	202.5
712	S415	1151	319.5
713	S414	1135	202.5
714	S413	1119	319.5
715	S412	1103	202.5
716	S411	1087	319.5
717	S410	1071	202.5
718	S409	1055	319.5
719	S408	1039	202.5
720	S407	1023	319.5
721	S406	1007	202.5
722	S405	991	319.5
723	S404	975	202.5
724	S403	959	319.5
725	S402	943	202.5
726	S401	927	319.5
727	S400	911	202.5
728	S399	895	319.5
729	S398	879	202.5
730	S397	863	319.5
731	S396	847	202.5
732	S395	831	319.5
733	S394	815	202.5
734	S393	799	319.5
735	S392	783	202.5
736	S391	767	319.5
737	S390	751	202.5
738	S389	735	319.5
739	S388	719	202.5
740	S387	703	319.5
741	S386	687	202.5
742	S385	671	319.5
743	S384	655	202.5
744	S383	639	319.5
745	S382	623	202.5
746	S381	607	319.5
747	S380	591	202.5
748	S379	575	319.5
749	S378	559	202.5
750	S377	543	319.5
751	S376	527	202.5
752	S375	511	319.5
753	S374	495	202.5
754	S373	479	319.5
755	S372	463	202.5
756	S371	447	319.5
757	S370	431	202.5
758	S369	415	319.5
759	S368	399	202.5
760	S367	383	319.5
761	S366	367	202.5
762	S365	351	319.5
763	S364	335	202.5
764	S363	319	319.5

No.	Pad Name	X	Y
765	S362	303	202.5
766	S361	287	319.5
767	DUMMY23	271	202.5
768	DUMMY24	-271	202.5
769	S360	-287	319.5
770	S359	-303	202.5
771	S358	-319	319.5
772	S357	-335	202.5
773	S356	-351	319.5
774	S355	-367	202.5
775	S354	-383	319.5
776	S353	-399	202.5
777	S352	-415	319.5
778	S351	-431	202.5
779	S350	-447	319.5
780	S349	-463	202.5
781	S348	-479	319.5
782	S347	-495	202.5
783	S346	-511	319.5
784	S345	-527	202.5
785	S344	-543	319.5
786	S343	-559	202.5
787	S342	-575	319.5
788	S341	-591	202.5
789	S340	-607	319.5
790	S339	-623	202.5
791	S338	-639	319.5
792	S337	-655	202.5
793	S336	-671	319.5
794	S335	-687	202.5
795	S334	-703	319.5
796	S333	-719	202.5
797	S332	-735	319.5
798	S331	-751	202.5
799	S330	-767	319.5
800	S329	-783	202.5
801	S328	-799	319.5
802	S327	-815	202.5
803	S326	-831	319.5
804	S325	-847	202.5
805	S324	-863	319.5
806	S323	-879	202.5
807	S322	-895	319.5
808	S321	-911	202.5
809	S320	-927	319.5
810	S319	-943	202.5
811	S318	-959	319.5
812	S317	-975	202.5
813	S316	-991	319.5
814	S315	-1007	202.5
815	S314	-1023	319.5
816	S313	-1039	202.5
817	S312	-1055	319.5
818	S311	-1071	202.5
819	S310	-1087	319.5

No.	Pad Name	X	Y
820	S309	-1103	202.5
821	S308	-1119	319.5
822	S307	-1135	202.5
823	S306	-1151	319.5
824	S305	-1167	202.5
825	S304	-1183	319.5
826	S303	-1199	202.5
827	S302	-1215	319.5
828	S301	-1231	202.5
829	S300	-1247	319.5
830	S299	-1263	202.5
831	S298	-1279	319.5
832	S297	-1295	202.5
833	S296	-1311	319.5
834	S295	-1327	202.5
835	S294	-1343	319.5
836	S293	-1359	202.5
837	S292	-1375	319.5
838	S291	-1391	202.5
839	S290	-1407	319.5
840	S289	-1423	202.5
841	S288	-1439	319.5
842	S287	-1455	202.5
843	S286	-1471	319.5
844	S285	-1487	202.5
845	S284	-1503	319.5
846	S283	-1519	202.5
847	S282	-1535	319.5
848	S281	-1551	202.5
849	S280	-1567	319.5
850	S279	-1583	202.5
851	S278	-1599	319.5
852	S277	-1615	202.5
853	S276	-1631	319.5
854	S275	-1647	202.5
855	S274	-1663	319.5
856	S273	-1679	202.5
857	S272	-1695	319.5
858	S271	-1711	202.5
859	S270	-1727	319.5
860	S269	-1743	202.5
861	S268	-1759	319.5
862	S267	-1775	202.5
863	S266	-1791	319.5
864	S265	-1807	202.5
865	S264	-1823	319.5
866	S263	-1839	202.5
867	S262	-1855	319.5
868	S261	-1871	202.5
869	S260	-1887	319.5
870	S259	-1903	202.5
871	S258	-1919	319.5
872	S257	-1935	202.5
873	S256	-1951	319.5
874	S255	-1967	202.5

No.	Pad Name	X	Y
875	S254	-1983	319.5
876	S253	-1999	202.5
877	S252	-2015	319.5
878	S251	-2031	202.5
879	S250	-2047	319.5
880	S249	-2063	202.5
881	S248	-2079	319.5
882	S247	-2095	202.5
883	S246	-2111	319.5
884	S245	-2127	202.5
885	S244	-2143	319.5
886	S243	-2159	202.5
887	S242	-2175	319.5
888	S241	-2191	202.5
889	S240	-2207	319.5
890	S239	-2223	202.5
891	S238	-2239	319.5
892	S237	-2255	202.5
893	S236	-2271	319.5
894	S235	-2287	202.5
895	S234	-2303	319.5
896	S233	-2319	202.5
897	S232	-2335	319.5
898	S231	-2351	202.5
899	S230	-2367	319.5
900	S229	-2383	202.5
901	S228	-2399	319.5
902	S227	-2415	202.5
903	S226	-2431	319.5
904	S225	-2447	202.5
905	S224	-2463	319.5
906	S223	-2479	202.5
907	S222	-2495	319.5
908	S221	-2511	202.5
909	S220	-2527	319.5
910	S219	-2543	202.5
911	S218	-2559	319.5
912	S217	-2575	202.5
913	S216	-2591	319.5
914	S215	-2607	202.5
915	S214	-2623	319.5
916	S213	-2639	202.5
917	S212	-2655	319.5
918	S211	-2671	202.5
919	S210	-2687	319.5
920	S209	-2703	202.5
921	S208	-2719	319.5
922	S207	-2735	202.5
923	S206	-2751	319.5
924	S205	-2767	202.5
925	S204	-2783	319.5
926	S203	-2799	202.5
927	S202	-2815	319.5
928	S201	-2831	202.5
929	S200	-2847	319.5

No.	Pad Name	X	Y
930	S199	-2863	202.5
931	S198	-2879	319.5
932	S197	-2895	202.5
933	S196	-2911	319.5
934	S195	-2927	202.5
935	S194	-2943	319.5
936	S193	-2959	202.5
937	S192	-2975	319.5
938	S191	-2991	202.5
939	S190	-3007	319.5
940	S189	-3023	202.5
941	S188	-3039	319.5
942	S187	-3055	202.5
943	S186	-3071	319.5
944	S185	-3087	202.5
945	S184	-3103	319.5
946	S183	-3119	202.5
947	S182	-3135	319.5
948	S181	-3151	202.5
949	S180	-3167	319.5
950	S179	-3183	202.5
951	S178	-3199	319.5
952	S177	-3215	202.5
953	S176	-3231	319.5
954	S175	-3247	202.5
955	S174	-3263	319.5
956	S173	-3279	202.5
957	S172	-3295	319.5
958	S171	-3311	202.5
959	S170	-3327	319.5
960	S169	-3343	202.5
961	S168	-3359	319.5
962	S167	-3375	202.5
963	S166	-3391	319.5
964	S165	-3407	202.5
965	S164	-3423	319.5
966	S163	-3439	202.5
967	S162	-3455	319.5
968	S161	-3471	202.5
969	S160	-3487	319.5
970	S159	-3503	202.5
971	S158	-3519	319.5
972	S157	-3535	202.5
973	S156	-3551	319.5
974	S155	-3567	202.5
975	S154	-3583	319.5
976	S153	-3599	202.5
977	S152	-3615	319.5
978	S151	-3631	202.5
979	S150	-3647	319.5
980	S149	-3663	202.5
981	S148	-3679	319.5
982	S147	-3695	202.5
983	S146	-3711	319.5
984	S145	-3727	202.5



No.	Pad Name	X	Y
985	S144	-3743	319.5
986	S143	-3759	202.5
987	S142	-3775	319.5
988	S141	-3791	202.5
989	S140	-3807	319.5
990	S139	-3823	202.5
991	S138	-3839	319.5
992	S137	-3855	202.5
993	S136	-3871	319.5
994	S135	-3887	202.5
995	S134	-3903	319.5
996	S133	-3919	202.5
997	S132	-3935	319.5
998	S131	-3951	202.5
999	S130	-3967	319.5
1000	S129	-3983	202.5
1001	S128	-3999	319.5
1002	S127	-4015	202.5
1003	S126	-4031	319.5
1004	S125	-4047	202.5
1005	S124	-4063	319.5
1006	S123	-4079	202.5
1007	S122	-4095	319.5
1008	S121	-4111	202.5
1009	S120	-4127	319.5
1010	S119	-4143	202.5
1011	S118	-4159	319.5
1012	S117	-4175	202.5
1013	S116	-4191	319.5
1014	S115	-4207	202.5
1015	S114	-4223	319.5
1016	S113	-4239	202.5
1017	S112	-4255	319.5
1018	S111	-4271	202.5
1019	S110	-4287	319.5
1020	S109	-4303	202.5
1021	S108	-4319	319.5
1022	S107	-4335	202.5
1023	S106	-4351	319.5
1024	S105	-4367	202.5
1025	S104	-4383	319.5
1026	S103	-4399	202.5
1027	S102	-4415	319.5
1028	S101	-4431	202.5
1029	S100	-4447	319.5
1030	S99	-4463	202.5
1031	S98	-4479	319.5
1032	S97	-4495	202.5
1033	S96	-4511	319.5
1034	S95	-4527	202.5
1035	S94	-4543	319.5
1036	S93	-4559	202.5
1037	S92	-4575	319.5
1038	S91	-4591	202.5
1039	S90	-4607	319.5

No.	Pad Name	X	Y
1040	S89	-4623	202.5
1041	S88	-4639	319.5
1042	S87	-4655	202.5
1043	S86	-4671	319.5
1044	S85	-4687	202.5
1045	S84	-4703	319.5
1046	S83	-4719	202.5
1047	S82	-4735	319.5
1048	S81	-4751	202.5
1049	S80	-4767	319.5
1050	S79	-4783	202.5
1051	S78	-4799	319.5
1052	S77	-4815	202.5
1053	S76	-4831	319.5
1054	S75	-4847	202.5
1055	S74	-4863	319.5
1056	S73	-4879	202.5
1057	S72	-4895	319.5
1058	S71	-4911	202.5
1059	S70	-4927	319.5
1060	S69	-4943	202.5
1061	S68	-4959	319.5
1062	S67	-4975	202.5
1063	S66	-4991	319.5
1064	S65	-5007	202.5
1065	S64	-5023	319.5
1066	S63	-5039	202.5
1067	S62	-5055	319.5
1068	S61	-5071	202.5
1069	S60	-5087	319.5
1070	S59	-5103	202.5
1071	S58	-5119	319.5
1072	S57	-5135	202.5
1073	S56	-5151	319.5
1074	S55	-5167	202.5
1075	S54	-5183	319.5
1076	S53	-5199	202.5
1077	S52	-5215	319.5
1078	S51	-5231	202.5
1079	S50	-5247	319.5
1080	S49	-5263	202.5
1081	S48	-5279	319.5
1082	S47	-5295	202.5
1083	S46	-5311	319.5
1084	S45	-5327	202.5
1085	S44	-5343	319.5
1086	S43	-5359	202.5
1087	S42	-5375	319.5
1088	S41	-5391	202.5
1089	S40	-5407	319.5
1090	S39	-5423	202.5
1091	S38	-5439	319.5
1092	S37	-5455	202.5
1093	S36	-5471	319.5
1094	S35	-5487	202.5

No.	Pad Name	X	Y
1095	S34	-5503	319.5
1096	S33	-5519	202.5
1097	S32	-5535	319.5
1098	S31	-5551	202.5
1099	S30	-5567	319.5
1100	S29	-5583	202.5
1101	S28	-5599	319.5
1102	S27	-5615	202.5
1103	S26	-5631	319.5
1104	S25	-5647	202.5
1105	S24	-5663	319.5
1106	S23	-5679	202.5
1107	S22	-5695	319.5
1108	S21	-5711	202.5
1109	S20	-5727	319.5
1110	S19	-5743	202.5
1111	S18	-5759	319.5
1112	S17	-5775	202.5
1113	S16	-5791	319.5
1114	S15	-5807	202.5
1115	S14	-5823	319.5
1116	S13	-5839	202.5
1117	S12	-5855	319.5
1118	S11	-5871	202.5
1119	S10	-5887	319.5
1120	S9	-5903	202.5
1121	S8	-5919	319.5
1122	S7	-5935	202.5
1123	S6	-5951	319.5
1124	S5	-5967	202.5
1125	S4	-5983	319.5
1126	S3	-5999	202.5
1127	S2	-6015	319.5
1128	S1	-6031	202.5
1129	DUMMY25	-6047	319.5
1130	DUMMY26	-6083	319.5
1131	G1	-6099	202.5
1132	G3	-6115	319.5
1133	G5	-6131	202.5
1134	G7	-6147	319.5
1135	G9	-6163	202.5
1136	G11	-6179	319.5
1137	G13	-6195	202.5
1138	G15	-6211	319.5
1139	G17	-6227	202.5
1140	G19	-6243	319.5
1141	G21	-6259	202.5
1142	G23	-6275	319.5
1143	G25	-6291	202.5
1144	G27	-6307	319.5
1145	G29	-6323	202.5
1146	G31	-6339	319.5
1147	G33	-6355	202.5
1148	G35	-6371	319.5
1149	G37	-6387	202.5



No.	Pad Name	X	Y
1150	G39	-6403	319.5
1151	G41	-6419	202.5
1152	G43	-6435	319.5
1153	G45	-6451	202.5
1154	G47	-6467	319.5
1155	G49	-6483	202.5
1156	G51	-6499	319.5
1157	G53	-6515	202.5
1158	G55	-6531	319.5
1159	G57	-6547	202.5
1160	G59	-6563	319.5
1161	G61	-6579	202.5
1162	G63	-6595	319.5
1163	G65	-6611	202.5
1164	G67	-6627	319.5
1165	G69	-6643	202.5
1166	G71	-6659	319.5
1167	G73	-6675	202.5
1168	G75	-6691	319.5
1169	G77	-6707	202.5
1170	G79	-6723	319.5
1171	G81	-6739	202.5
1172	G83	-6755	319.5
1173	G85	-6771	202.5
1174	G87	-6787	319.5
1175	G89	-6803	202.5
1176	G91	-6819	319.5
1177	G93	-6835	202.5
1178	G95	-6851	319.5
1179	G97	-6867	202.5
1180	G99	-6883	319.5
1181	G101	-6899	202.5
1182	G103	-6915	319.5
1183	G105	-6931	202.5
1184	G107	-6947	319.5
1185	G109	-6963	202.5
1186	G111	-6979	319.5
1187	G113	-6995	202.5
1188	G115	-7011	319.5
1189	G117	-7027	202.5
1190	G119	-7043	319.5
1191	G121	-7059	202.5
1192	G123	-7075	319.5
1193	G125	-7091	202.5
1194	G127	-7107	319.5
1195	G129	-7123	202.5
1196	G131	-7139	319.5
1197	G133	-7155	202.5
1198	G135	-7171	319.5

No.	Pad Name	X	Y
1199	G137	-7187	202.5
1200	G139	-7203	319.5
1201	G141	-7219	202.5
1202	G143	-7235	319.5
1203	G145	-7251	202.5
1204	G147	-7267	319.5
1205	G149	-7283	202.5
1206	G151	-7299	319.5
1207	G153	-7315	202.5
1208	G155	-7331	319.5
1209	G157	-7347	202.5
1210	G159	-7363	319.5
1211	G161	-7379	202.5
1212	G163	-7395	319.5
1213	G165	-7411	202.5
1214	G167	-7427	319.5
1215	G169	-7443	202.5
1216	G171	-7459	319.5
1217	G173	-7475	202.5
1218	G175	-7491	319.5
1219	G177	-7507	202.5
1220	G179	-7523	319.5
1221	G181	-7539	202.5
1222	G183	-7555	319.5
1223	G185	-7571	202.5
1224	G187	-7587	319.5
1225	G189	-7603	202.5
1226	G191	-7619	319.5
1227	G193	-7635	202.5
1228	G195	-7651	319.5
1229	G197	-7667	202.5
1230	G199	-7683	319.5
1231	G201	-7699	202.5
1232	G203	-7715	319.5
1233	G205	-7731	202.5
1234	G207	-7747	319.5
1235	G209	-7763	202.5
1236	G211	-7779	319.5
1237	G213	-7795	202.5
1238	G215	-7811	319.5
1239	G217	-7827	202.5
1240	G219	-7843	319.5
1241	G221	-7859	202.5
1242	G223	-7875	319.5
1243	G225	-7891	202.5
1244	G227	-7907	319.5
1245	G229	-7923	202.5
1246	G231	-7939	319.5
1247	G233	-7955	202.5

No.	Pad Name	X	Y
1248	G235	-7971	319.5
1249	G237	-7987	202.5
1250	G239	-8003	319.5
1251	G241	-8019	202.5
1252	G243	-8035	319.5
1253	G245	-8051	202.5
1254	G247	-8067	319.5
1255	G249	-8083	202.5
1256	G251	-8099	319.5
1257	G253	-8115	202.5
1258	G255	-8131	319.5
1259	G257	-8147	202.5
1260	G259	-8163	319.5
1261	G261	-8179	202.5
1262	G263	-8195	319.5
1263	G265	-8211	202.5
1264	G267	-8227	319.5
1265	G269	-8243	202.5
1266	G271	-8259	319.5
1267	G273	-8275	202.5
1268	G275	-8291	319.5
1269	G277	-8307	202.5
1270	G279	-8323	319.5
1271	G281	-8339	202.5
1272	G283	-8355	319.5
1273	G285	-8371	202.5
1274	G287	-8387	319.5
1275	G289	-8403	202.5
1276	G291	-8419	319.5
1277	G293	-8435	202.5
1278	G295	-8451	319.5
1279	G297	-8467	202.5
1280	G299	-8483	319.5
1281	G301	-8499	202.5
1282	G303	-8515	319.5
1283	G305	-8531	202.5
1284	G307	-8547	319.5
1285	G309	-8563	202.5
1286	G311	-8579	319.5
1287	G313	-8595	202.5
1288	G315	-8611	319.5
1289	G317	-8627	202.5
1290	G319	-8643	319.5
1291	DUMMY27	-8659	202.5



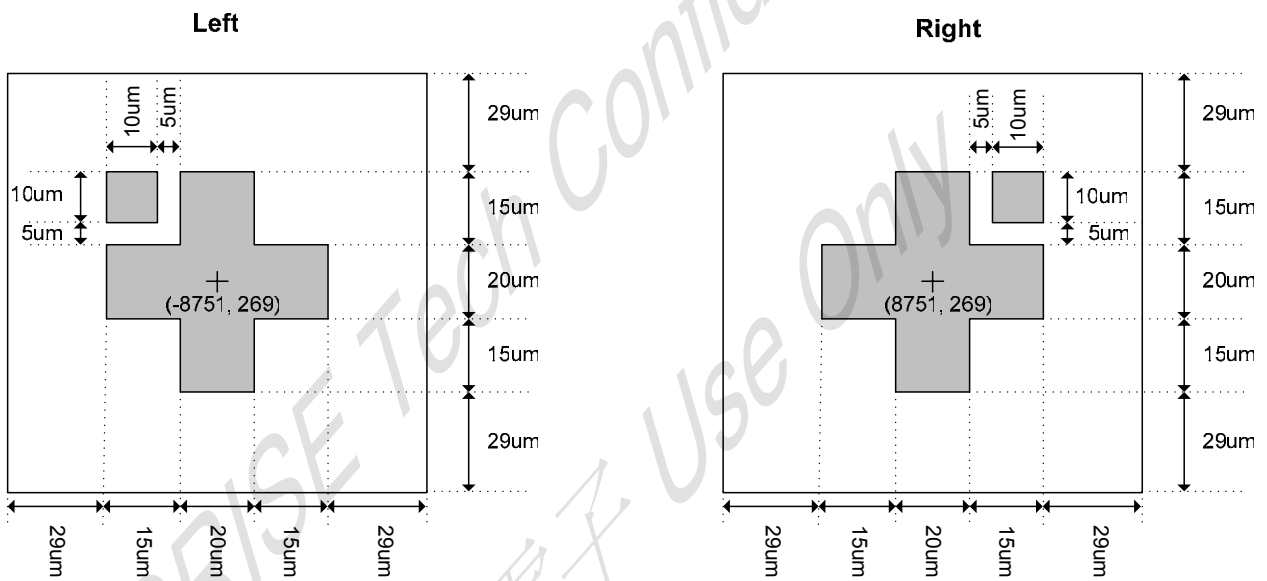
### 15.5. Alignment Mark

--Alignment Mark coordinate

Left (-8751, 269)

Right (8751, 269)

--Alignment Mark size





## 16. DISCLAIMER

The information appearing in this publication is believed to be accurate.

Integrated circuits sold by ORISE Technology are covered by the warranty and patent indemnification provisions stipulated in the terms of sale only. ORISE Technology makes no warranty, express, statutory implied or by description regarding the information in this publication or regarding the freedom of the described chip(s) from patent infringement. FURTHERMORE, ORISE Technology MAKES NO WARRANTY OF MERCHANTABILITY OR FITNESS FOR ANY PURPOSE. ORISE Technology reserves the right to halt production or alter the specifications and prices at any time without notice. Accordingly, the reader is cautioned to verify that the data sheets and other information in this publication are current before placing orders. Products described herein are intended for use in normal commercial applications. Applications involving unusual environmental or reliability requirements, e.g. military equipment or medical life support equipment, are specifically not recommended without additional processing by ORISE Technology for such applications. Please note that application circuits illustrated in this document are for reference purposes only.

ORISE Tech Confidential  
For 昭揚電子 Use Only

## 17. REVISION HISTORY

Date	Revision #	Description	Page
DEC. 24, 2007	0.4	1. modify R03 description	15
		2. modify write data to GRAM format	28
		3. modify 80 system 16-/8- bit interface format	45
		4. modify SPI format	46
		5. Add PAD Assignment.	72
NOV. 22, 2007	0.3	1. Modify Pad size.	72
		2. Modify Alignment Mark.	81
NOV. 12, 2007	0.2	1. Modify SIGNAL DESCRIPTIONS	10~11
		2. Modify Instruction (R30h~R3Fh) and $\gamma$ Control (R30h to R3Fh)	13, 32
		3. Modify Panel Control 3 (R12h)	24
		4. Modify Power Management System:	59~61
		5. Modify PAD Dimension.	72
OCT. 29, 2007	0.1	Original version	84