

SPGP0380A

VER : Preliminary_2
(SEMIHOW POWER SWITCH)

FEATURES

- Variable frequency operation
- Low Start-up Current(Typ.100uA)
- Pulse by Pulse Current Limiting
- Over Current Protection
- Over Voltage Protection (Min. 20)
- Internal Thermal Shutdown Function
- Under Voltage Lockout
- Internal High Voltage Sense FET
- Auto-Restart Mode
- Frequency Modulation for low EMI
- Advanced Burst-Mode Operation

APPLICATION

- SMPS for STB, SVR, DVD & DVCD
- SMPS for Printer, Facsimile & Scanner
- Adaptor

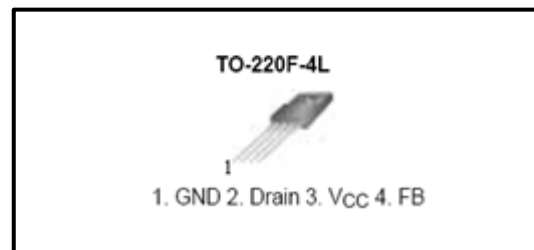

DESCRIPTION

The SemiHow Power Switch product family is specially designed for an off-line SMPS with minimal external components.

The SemiHow Power Switch consists of a high voltage power SenseFET and a current mode PWM IC.

It has a basic platform well suited for the cost effective design in either a flyback converter

INTERNAL BLOCK DIAGRAM

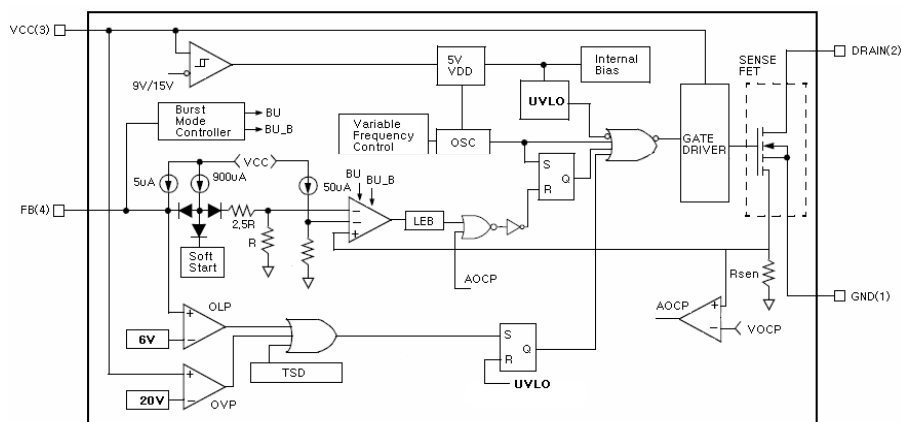

Absolute Maximum Ratings

Ta=25°C, unless otherwise specified

Symbol	Parameter	Value	Units
V _{DSS}	Drain-Source Voltage	800	V
I _D	Drain Current – Continuous (T _C = 25 °C)	3.0	A
	Drain Current – Continuous (T _C = 100 °C)	2.1	A
I _{DM}	Drain Current – Pulsed (Note 1)	12	A
V _{GS}	Gate-Source Voltage	±30	V
E _{AS}	Single Pulsed Avalanche Energy (Note 2)	245	mJ
V _{CC(MAX)}	Maximum Supply voltage	20	V
V _{FB}	Analog Input Voltage Range	-0.3 To V _{SD}	V
P _D	Power Dissipation (T _C = 25 °C)	100	W
	- Derate above 25 °C	0.8	W/°C
T _J	Operating Junction Temperature	+160	°C
T _A	Operating Ambient Temperature	-25 to +85	°C
T _{STG}	Storage Temperature Range	-55 to +150	°C

Notes :

1. Repetitive Rating : Pulse width limited by maximum junction temperature
2. L=51mH, I_{AS}=3.0A, V_{DD}=50V, R_G=25Ω, Starting T_J=25°C

Electrical Characteristics (SenseFET Part)

Ta=25°C, unless otherwise specified

Symbol	Parameter	Test Conditions	Min	Typ	Max	Units
On Characteristics						
$R_{DS(ON)}$	Static Drain-Source On-Resistance	$V_{GS} = 10\text{ V}, I_D = 1.5\text{ A}$	--	4.0	5.0	Ω
Off Characteristics						
BV_{DSS}	Drain-Source Breakdown Voltage	$V_{GS} = 0\text{ V}, I_D = 50\ \mu\text{A}$	800	--	--	V
I_{DSS}	Zero Gate Voltage Drain Current	$V_{DS} = 800\text{ V}, V_{GS} = 0\text{ V}$	--	--	250	μA
		$V_{DS} = 640\text{ V}, T_C = 125^\circ\text{C}$	--	--	1000	μA
Dynamic Characteristics						
C_{iss}	Input Capacitance	$V_{DS} = 25\text{ V}, V_{GS} = 0\text{ V},$ $f = 1.0\text{ MHz}$	--	650	850	pF
C_{oss}	Output Capacitance		--	55	72	pF
C_{rss}	Reverse Transfer Capacitance		--	12	15.5	pF
Switching Characteristics						
$t_{d(on)}$	Turn-On Time	$V_{DS} = 400\text{ V}, I_D = 3.0\text{ A},$ $R_G = 25\ \Omega$ (Note 4,5)	--	20	--	ns
T_r	Turn-On Rise Time		--	20	--	ns
$t_{d(off)}$	Turn-Off Delay Time		--	80	--	ns
t_f	Turn-Off Fall Time		--	40	--	ns
Q_g	Total Gate Charge	$V_{DS} = 400\text{ V}, I_D = 3.0\text{ A},$ $V_{GS} = 10\text{ V}$ (Note 4,5)	--	16	21	nC
Q_{gs}	Gate-Source Charge		--	3.5	--	nC
Q_{gd}	Gate-Drain Charge		--	6.5	--	nC

Notes :

1. Pulse Test : Pulse Width $\leq 300\ \mu\text{s}$, Duty Cycle $\leq 2\%$

2. $S = \frac{1}{R}$

Electrical Characteristics (Control Part)

Ta=25°C, unless otherwise specified

Symbol	Parameter	Test Conditions	Min	Typ	Max	Units
UVLO Section						
V _{START}	Start Threshold Voltage	V _{FB} = GND	14	15	16	V
V _{STOP}	Stop Threshold Voltage	V _{FB} = GND	8.4	9	9.6	V
Oscillator Section						
F _{OSC}	Initial Accuracy		57	64	71	KHz
--	Frequency Change With Temperature (Note 2)	-25°C ≤ Ta ≤ +85°C	--	±5	±10	%
D _{MAX}	Maximum Duty Cycle		73	77	82	%
FEEDBACK Section						
I _{FB}	Feedback Source Current	Ta=25°C, 0V<Vfb<3V	0.7	0.9	1.1	mA
V _{SD}	Shutdown Feedback Voltage	Vfb>6.5V	5.4	6	6.6	V
I _{delay}	Shutdown Delay Current	Ta=25°C, 5VδVfbδVSD	4	5	6	mA
Reference Section						
V _{REF}	Reference Output Voltage (Note 1)	Ta=25°C	4.8	5	5.2	V
V _{ref} /ΔT	Temperature Stability (Note 1, 2)	-25°C ≤ Ta ≤ +85°C	--	0.3	0.6	mV/°C
I _{OVER}	Peak Current Limit	Max. inductor current	1.62	2.0	2.38	A
Protection Section						
V _{OV_P}	Over Voltage Protection	VCC > 20V	20	--	23	V
T _{SD}	Thermal Shutdown Temperature (Tj) (Note 1)	--	140	160	--	°C
Protection Section						
I _{START}	Start-up Current	VCC = 14V	--	100	170	μA
I _{OP}	Operating Supply Current (Control Part Only)	VCC < 20V	--	3	6	mA

Notes :

1. These parameters, although guaranteed, are not 100% tested in production
2. These parameters, although guaranteed, are tested in EDS(water test) process

Typical Characteristics (SenseFET Part) (SPGP0380A)

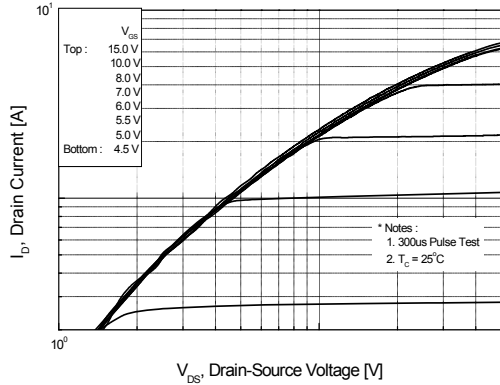

Figure 1. On Region Characteristics

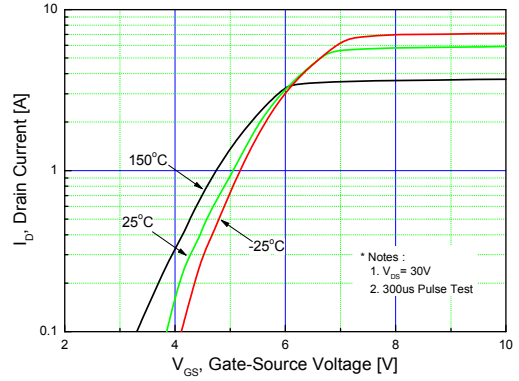

Figure 2. Transfer Characteristics

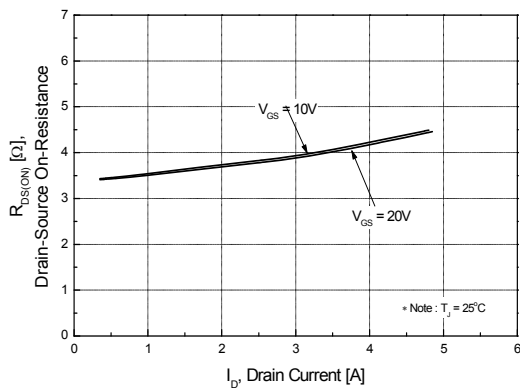

Figure 3. On Resistance Variation vs Drain Current and Gate Voltage

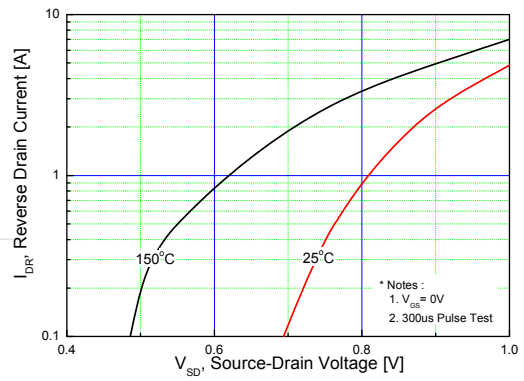

Figure 4. Body Diode Forward Voltage Variation with Source Current and Temperature

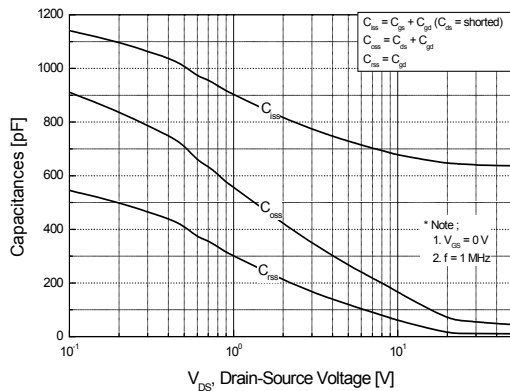

Figure 5. Capacitance Characteristics

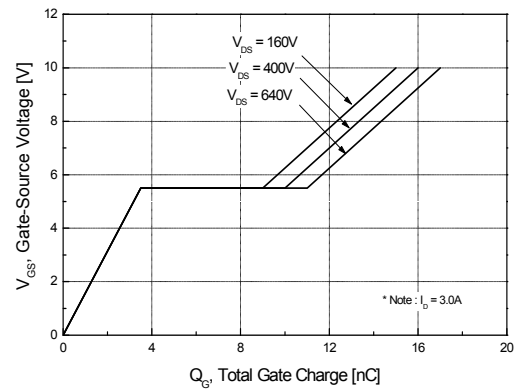

Figure 6. Gate Charge Characteristics

Typical Characteristics (SenseFET Part) (continued)
(SPGP0380A)

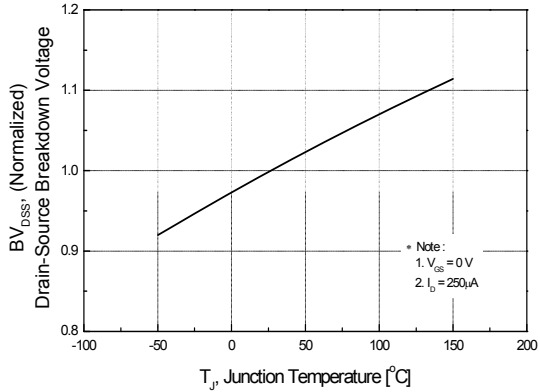

Figure 7. Breakdown Voltage Variation vs Temperature

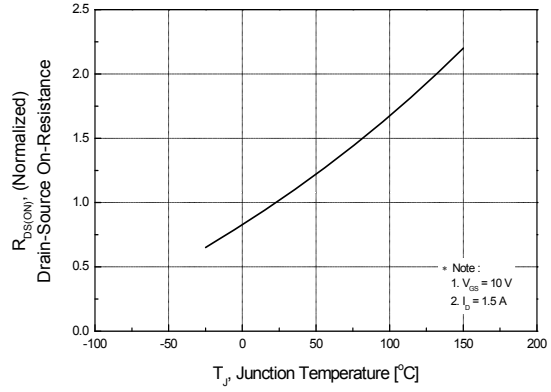

Figure 8. On-Resistance Variation vs Temperature

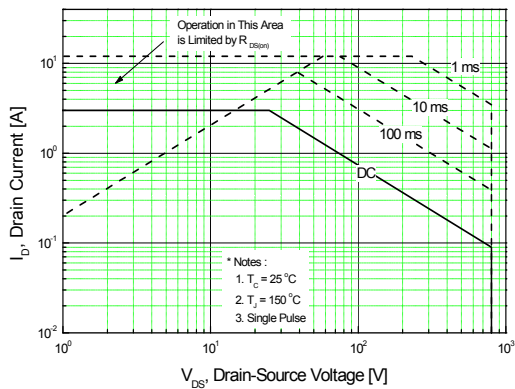

Figure 9. Maximum Safe Operating Area

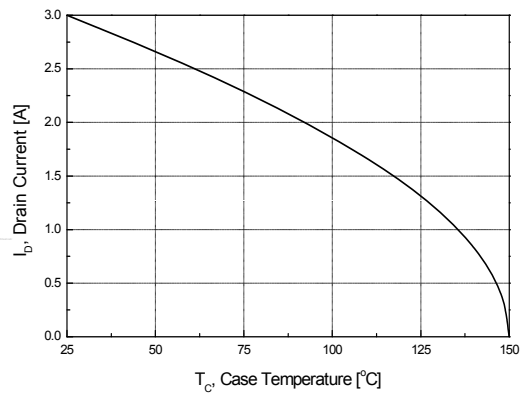

Figure 10. Maximum Drain Current vs Case Temperature

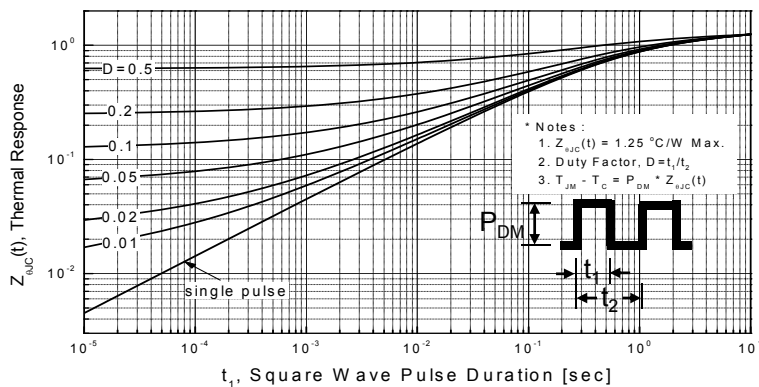

Figure 11. Transient Thermal Response Curve

Typical Performance Characteristics (Control Part) (continued)

(These characteristic graphs are normalized at Ta=25°C)

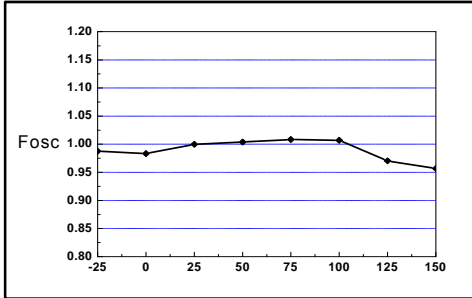

Figure 1. Operating Frequency

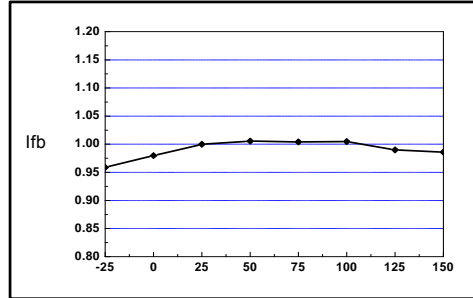

Figure 2. Feedback Source Current

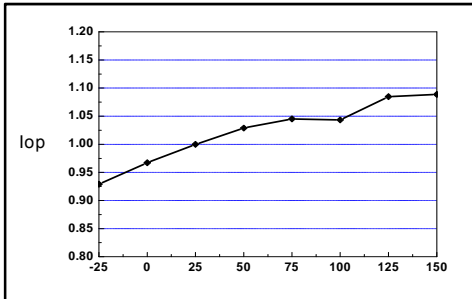

Figure 3. Operating Supply Current

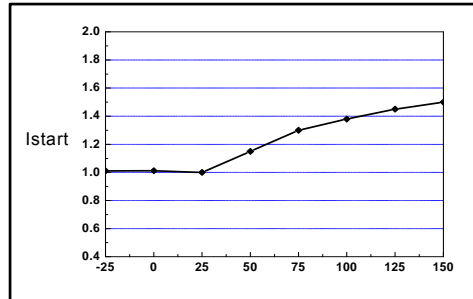

Figure 4. Start up Current

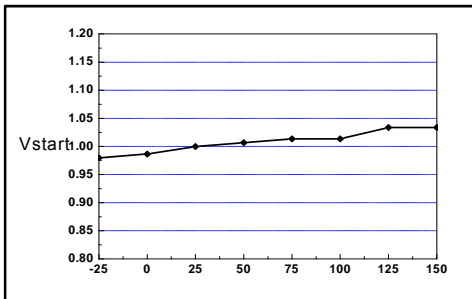

Figure 5. Start Threshold Voltage

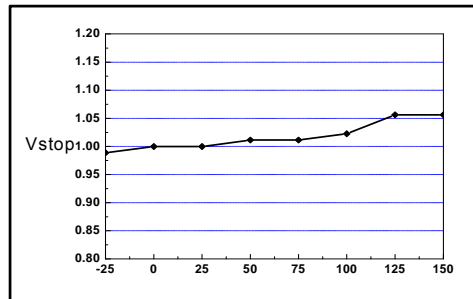

Figure 6. Stop Threshold Voltage

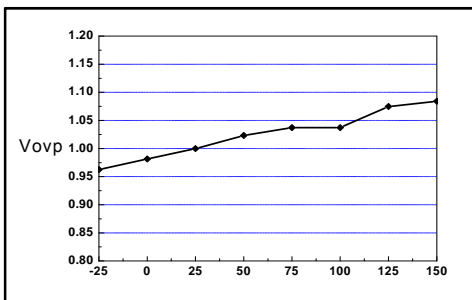
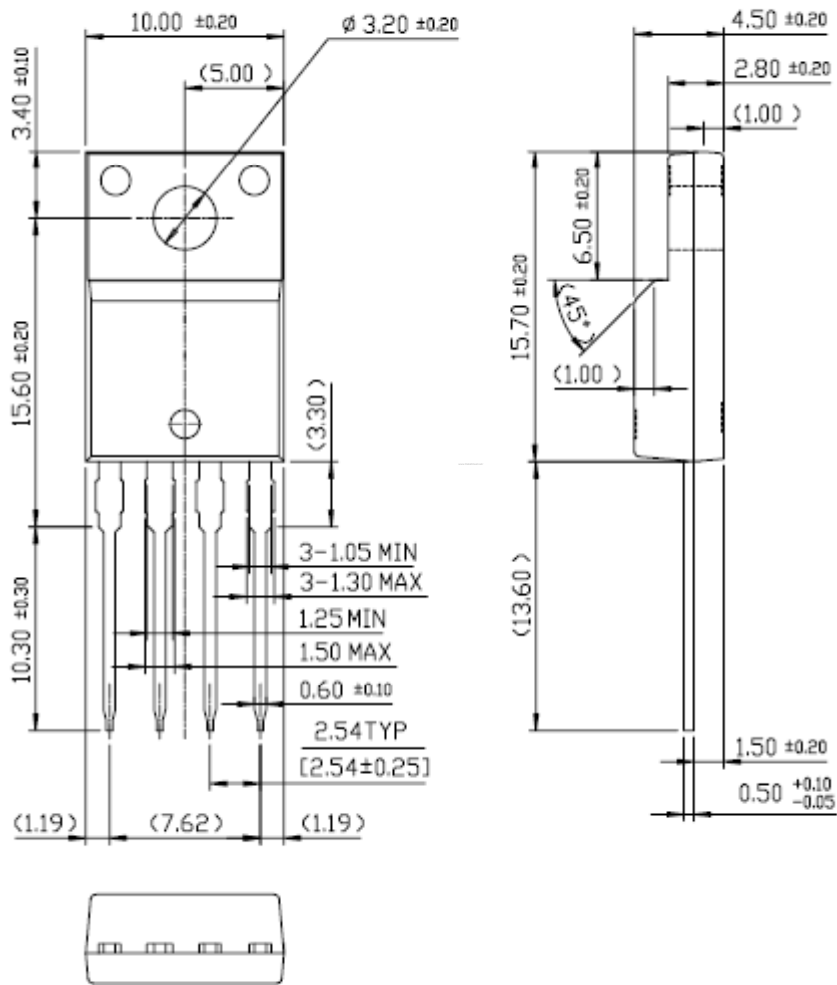

Figure 7. Over Voltage Protection

Package Dimension

TO-220F-4L



SPGP0380A-Preliminary