



SPL1310-4-9-PD



TECHNICAL DATA

Pigtailed Coaxial Laser Diode

Features

- 1310 nm
- SM Fiber
- Coaxial package
- Built-in PD

Applications

- Optical Bidi Module and Optical Receiver
- Optical Transmitter



Specifications (25°C)

Type	Min.	Typ.	Max.	Unit
Optical Specification				
Output Power P_F	-	4	-	mW
Center Wavelength λ_C	1290	1310	1330	nm
Spectral Width $\Delta\lambda$	-	-	-	nm
Fiber Characteristics				
Fiber Core Size	-	9	-	μm
Fiber Length	-	0.8	1.0	m
Connector	FC/SC/ST/LC/MU			
Electrical Specification				
Slope Efficiency E_S	-	-	-	mW/mA
Threshold Current I_{th}	5	-	15	mA
Operation Current I_{op}	-	35	-	mA
Operation Voltage V_f	-	1.1	1.6	V
Monitor Current I_m	0.1	-	-	mA
PD Reverse Voltage	-	15	-	V
PD Capacitance	-	10	15	pF
PD Dark Current	-	-	0.1	μA
Side Mode Suppression Ration	30	35	-	dB
Data Rate	1.25			Gb/s
Package Style	Coaxial			
Absolute Maximum Ratings				
Reverse Voltage V_r	2.0			V
Operating Temperature T_{Op}	-10 ... +50			°C
Storage Temperature T_{stg}	-40 ... +85			°C
Lead Soldering Temperature (10 sec.)	260			°C

The above specifications are for reference purpose only and subjected to change without prior notice.



Electrical Connection

Pin Configuration - Type A (standard)	Bottom View										
<table border="1"> <thead> <tr> <th>PIN</th> <th>Function</th> </tr> </thead> <tbody> <tr> <td>1</td> <td>PD Anode</td> </tr> <tr> <td>2</td> <td>LD Cathode</td> </tr> <tr> <td>3</td> <td>LD Anode, GND</td> </tr> <tr> <td>4</td> <td>PD Cathode</td> </tr> </tbody> </table>	PIN	Function	1	PD Anode	2	LD Cathode	3	LD Anode, GND	4	PD Cathode	
PIN	Function										
1	PD Anode										
2	LD Cathode										
3	LD Anode, GND										
4	PD Cathode										
Pin Configuration - Type B (on request)	Bottom View										
<table border="1"> <thead> <tr> <th>PIN</th> <th>Function</th> </tr> </thead> <tbody> <tr> <td>1</td> <td>LD Anode, PD Cathode</td> </tr> <tr> <td>2</td> <td>LD Cathode</td> </tr> <tr> <td>3</td> <td>n.c.</td> </tr> <tr> <td>4</td> <td>PD Anode</td> </tr> </tbody> </table>	PIN	Function	1	LD Anode, PD Cathode	2	LD Cathode	3	n.c.	4	PD Anode	
PIN	Function										
1	LD Anode, PD Cathode										
2	LD Cathode										
3	n.c.										
4	PD Anode										

Package Dimensions (Unit: mm)

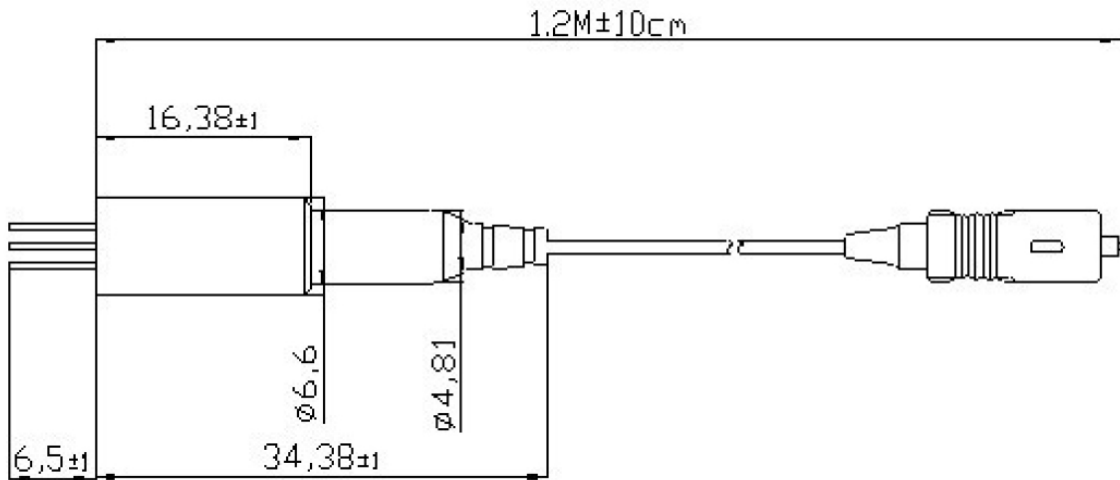

Safety of Laser light

- Laser Light can damage the human eyes and skin. Do not expose the eye or skin directly to any laser light and/or through optical lens. When handling the LDs, wear appropriate safety glasses to prevent laser light, even any reflections from entering to the eye. Focused laser beam through optical instruments will increase the chance of eye hazard.
- These LDs are emitting invisible light.





Cautions

1. Operating methode

- This LD shall change its forward voltage requirement and optical ouput power according to temperature change. Also, the LD will require more operation current to maintain same ouput power as it degrades. In order to maintain output power, use of APC (Automatic Power Control) is recommended. Which use monitor feedback to adjust the operation current.
- Confirm that electrical spike current generated by swithing on and off does not exceed the maximum operating current level specified herein above as absolute maximum rating. Also, employ appropriat countermeasures to reduce chattering and/or overshooting in the circuit.

2. Static Electricity

- Static electricity or electrical surges will reduce and degrade the reliability of the LDs. It is recommended to use a wrist trap or anti-electrostatic glove when handeling the product.

3. Absolute Maximum Rating

- Active layer of LDs shall have high current density and generate high electric field during its operation. In order to prevent excessive damage, the LD must be operated stricly below absolute maximum rating.



NOTE
LASERDIODE
MUST BE COOLED