

RoHS Compliant Product
A suffix of "-C" specifies halogen & lead-free

DESCRIPTION

The SPR1084N03-C provide the designer with the best combination of fast switching, ruggedized device design, low on-resistance and cost-effectiveness. The PR-8PP package is universally preferred for all commercial-industrial surface mount applications and suited for low voltage applications such as DC/DC converters.

FEATURES

- Lower Gate Charge
- Simple Drive Requirement
- Fast Switching Characteristic

MARKING

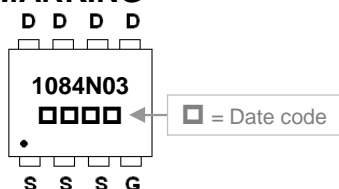

PACKAGE INFORMATION

Package	MPQ	Leader Size
PR-8PP	3K	13 inch

ORDER INFORMATION

Part Number	Type
SPR45N10-C	Lead (Pb)-free and Halogen-free

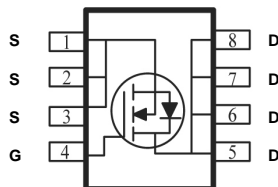

PR-8PP

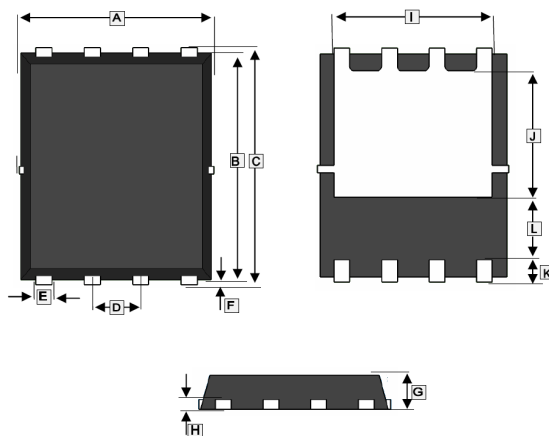

REF.	Millimeter		REF.	Millimeter	
	Min.	Max.		Min.	Max.
A	4.9	5.1	G	0.8	1.0
B	5.7	5.9	H	0.254 REF.	
C	5.95	6.2	I	4.0 REF.	
D	1.27 BSC.		J	3.4 REF.	
E	0.35	0.49	K	0.6 REF.	
F	0.1	0.2	L	1.4 REF.	

Mounting Pad Layout

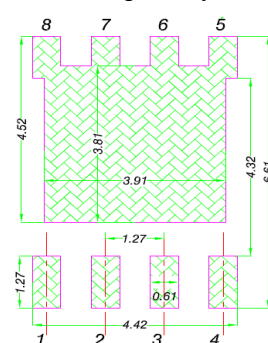

*Dimensions in millimeters

ABSOLUTE MAXIMUM RATINGS ($T_A=25^\circ\text{C}$ unless otherwise specified)

Parameter	Symbol	Rating	Unit
Drain-Source Voltage	V_{DS}	30	V
Gate-Source Voltage	V_{GS}	± 20	V
Continuous Drain Current ¹ @ $V_{GS}=10\text{V}$	$T_C=25^\circ\text{C}$	108	A
	$T_C=100^\circ\text{C}$	68	
Pulsed Drain Current ²	I_{DM}	216	A
Single Pulse Avalanche Energy ³	E_{AS}	317	mJ
Avalanche Current	I_{AS}	25.2	A
Total Power Dissipation ⁴	P_D	69	W
Operating Junction & Storage Temperature	T_J, T_{STG}	-55~150	$^\circ\text{C}$
Thermal Resistance Rating			
Thermal Resistance Junction-Ambient ¹ (Max.)	$R_{\theta JA}$	36	$^\circ\text{C/W}$
Thermal Resistance Junction-Case ¹ (Max.)	$R_{\theta JC}$	1.8	

ELECTRICAL CHARACTERISTICS ($T_J=25^\circ\text{C}$ unless otherwise specified)

Parameter	Symbol	Min.	Typ.	Max.	Unit	Test Conditions	
Drain-Source Breakdown Voltage	BV_{DSS}	30	-	-	V	$V_{GS}=0, I_D=250\mu\text{A}$	
Gate-Threshold Voltage	$V_{GS(th)}$	1.0	-	2.5	V	$V_{DS}=V_{GS}, I_D=250\mu\text{A}$	
Forward Transfer conductance	g_{fs}	-	26.5	-	S	$V_{DS}=5\text{V}, I_D=30\text{A}$	
Gate-Source Leakage Current	I_{GSS}	-	-	± 100	nA	$V_{GS}=\pm 20\text{V}$	
Drain-Source Leakage Current	I_{DSS}	$T_J=25^\circ\text{C}$	-	-	1	μA	$V_{DS}=24\text{V}, V_{GS}=0$
		$T_J=55^\circ\text{C}$	-	-	5		$V_{DS}=24\text{V}, V_{GS}=0$
Static Drain-Source On-Resistance ²	$R_{DS(ON)}$	-	3.2	4	m Ω	$V_{GS}=10\text{V}, I_D=30\text{A}$	
		-	4.1	6		$V_{GS}=4.5\text{V}, I_D=15\text{A}$	
Gate Resistance	R_g	-	3	4	Ω	$f=1\text{MHz}$	
Total Gate Charge	Q_g	-	31.6	-	nC	$I_D=12\text{A}$ $V_{DS}=20\text{V}$ $V_{GS}=4.5\text{V}$	
Gate-Source Charge	Q_{gs}	-	6.07	-			
Gate-Drain ("Miller") Change	Q_{gd}	-	13.8	-			
Turn-on Delay Time ²	$T_{d(on)}$	-	11.2	-	nS	$V_{DD}=15\text{V}$ $I_D=20\text{A}$ $V_{GS}=10\text{V}$ $R_G=1.5\Omega$	
Rise Time	T_r	-	49	-			
Turn-off Delay Time	$T_{d(off)}$	-	35	-			
Fall Time	T_f	-	7.8	-			
Input Capacitance	C_{iss}	-	3075	-	pF	$V_{GS}=0$ $V_{DS}=15\text{V}$ $f=1\text{MHz}$	
Output Capacitance	C_{oss}	-	400	-			
Reverse Transfer Capacitance	C_{rss}	-	315	-			
Single Pulse Avalanche Energy ⁵	E_{AS}	98	-	-	mJ	$V_{DD}=25\text{V}, L=1\text{mH}, I_{AS}=14\text{A}$	
Source-Drain Diode							
Diode Forward Voltage ²	V_{SD}	-	-	1	V	$I_S=1\text{A}, V_{GS}=0\text{V}$	
Continuous Source Current ^{1 6}	I_S	-	-	108	A	$V_{GS}=V_D=0, \text{Force Current}$	
Pulsed Source Current ^{2 6}	I_{SM}	-	-	216	A		

Notes:

1. The data tested by surface mounted on a 1 inch² FR-4 board with 2oz copper, $\leq 10\text{sec}$, 125°C/W at steady state.
2. The data tested by pulsed, pulse width $\leq 300\mu\text{s}$, duty cycle $\leq 2\%$.
3. The E_{AS} data shows Max. rating. The test condition is $V_{DD}=25\text{V}, V_{GS}=10\text{V}, L=1\text{mH}, I_{AS}=25.2\text{A}$.
4. The power dissipation is limited by 150°C junction temperature.
5. The Min. value is 100% E_{AS} tested guarantee.
6. The data is theoretically the same as I_D and I_{DM} , in real applications, should be limited by total power dissipation.

CHARACTERISTIC CURVES

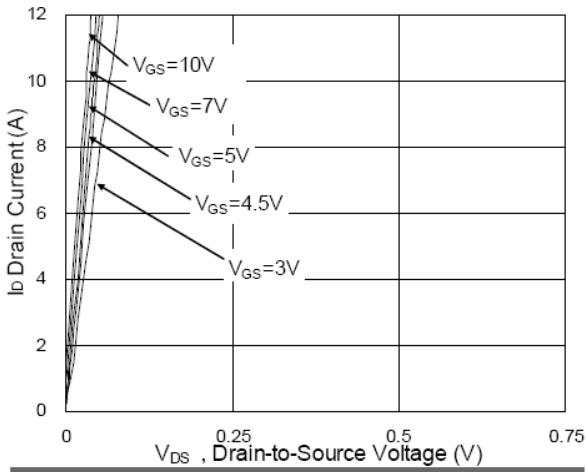

Fig.1 Typical Output Characteristics

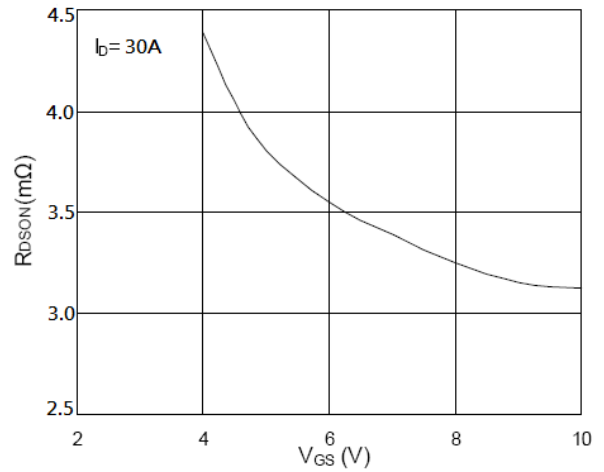

Fig.2 On-Resistance vs. G-S Voltage

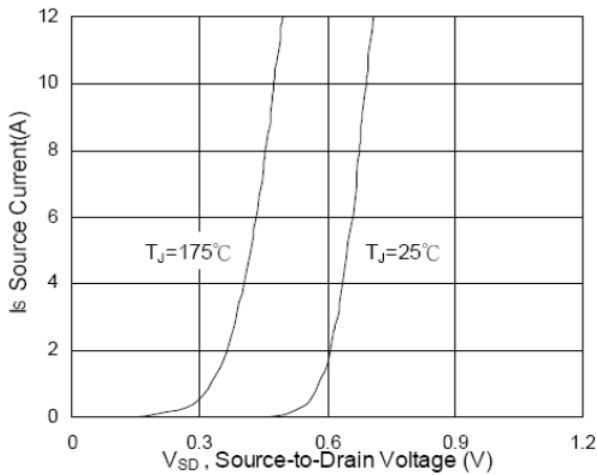

Fig.3 Forward Characteristics of Reverse

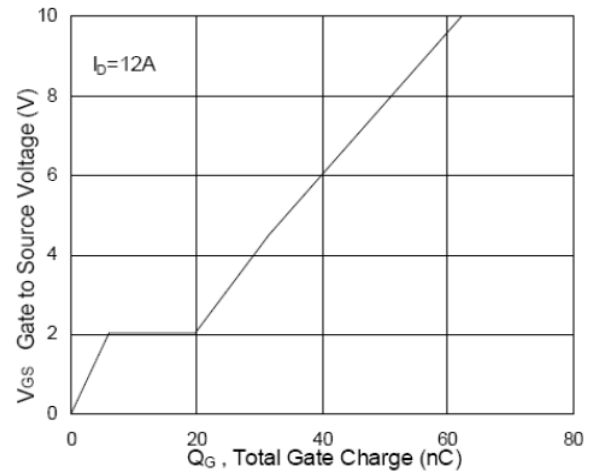

Fig.4 Gate-charge Characteristics

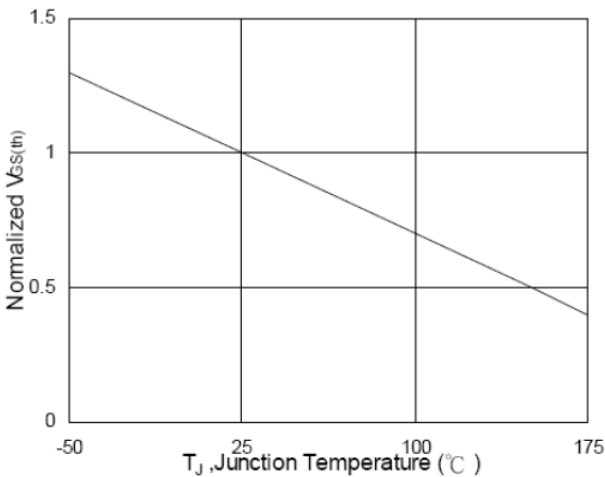

Fig.5 Normalized $V_{GS(th)}$ vs. T_J

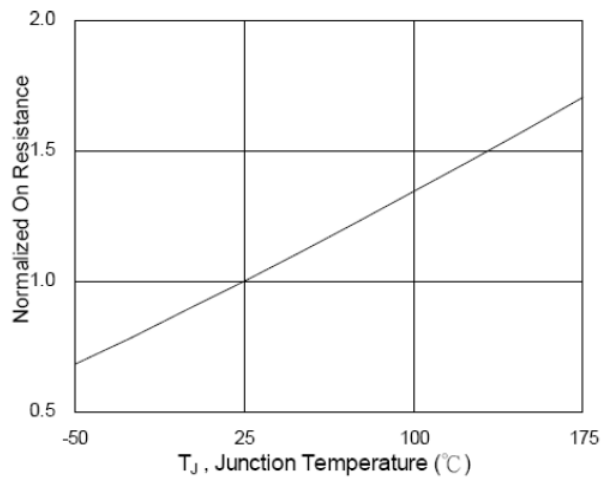

Fig.6 Normalized $R_{DS(ON)}$ vs. T_J

CHARACTERISTIC CURVES

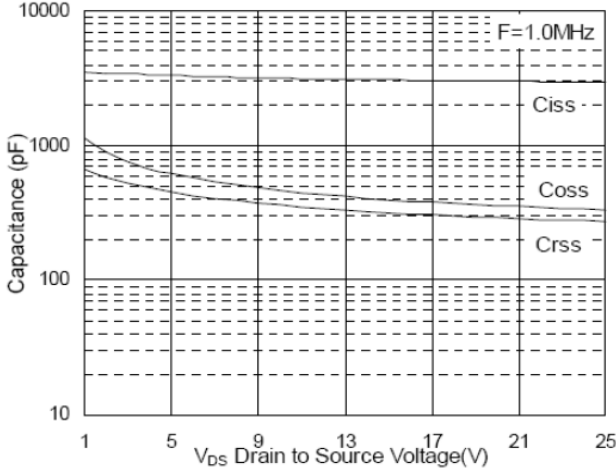

Fig.7 Capacitance

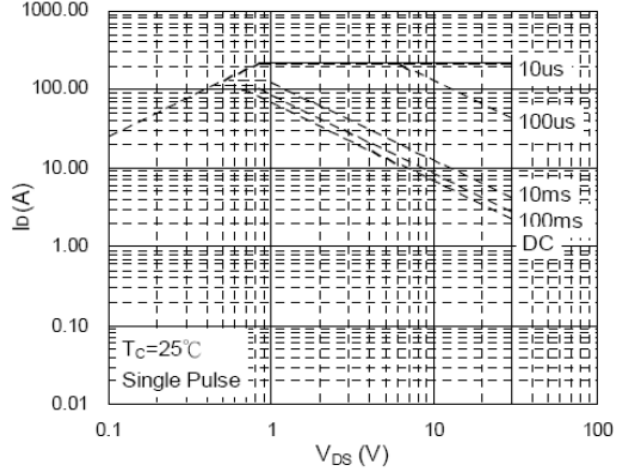

Fig.8 Safe Operating Area

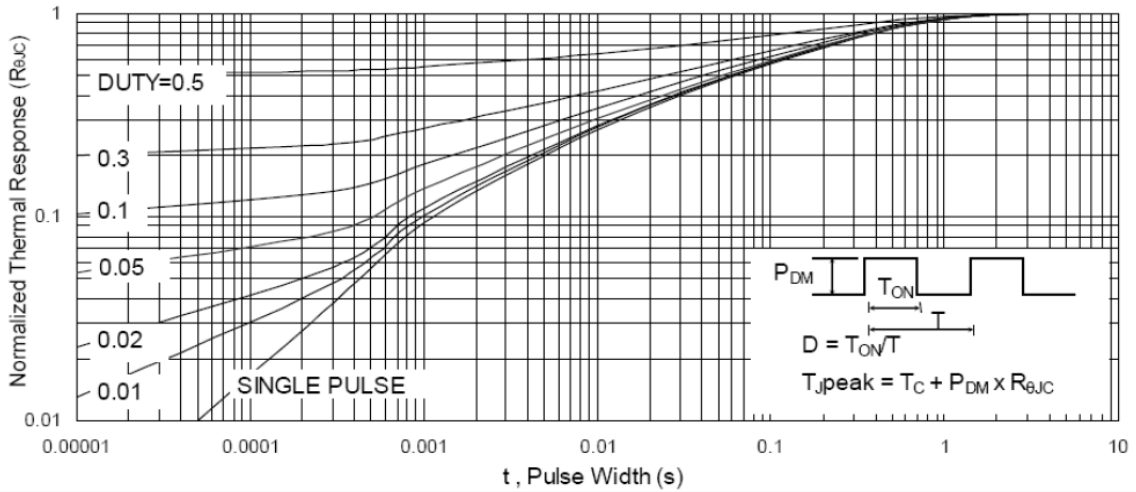

Fig.9 Normalized Maximum Transient Thermal Impedance

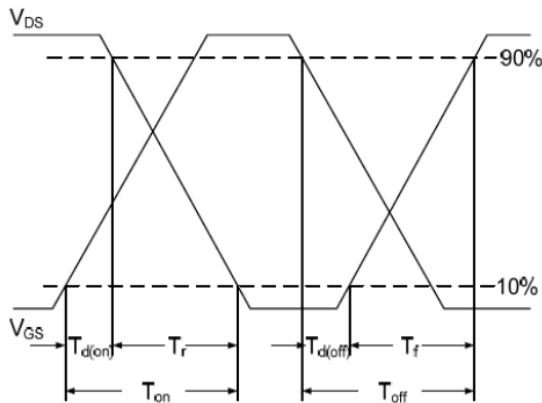

Fig.10 Switching Time Waveform

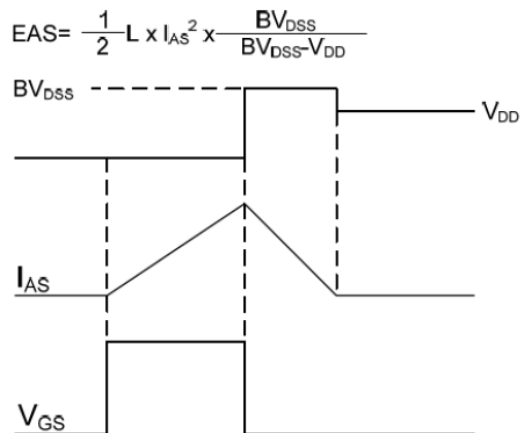

Fig.11 Unclamped Inductive Switching Waveform