

RoHS Compliant Product
A suffix of "-C" specifies halogen & lead-free

DESCRIPTION

The SPR50N03 provide the designer with the best combination of fast switching, ruggedized device design, low on-resistance and cost-effectiveness. The PR-8PP package is universally preferred for all commercial-industrial surface mount applications and suited for low voltage applications such as DC/DC converters.

FEATURES

- Lower Gate Charge
- Simple Drive Requirement
- Fast Switching Characteristic

MARKING

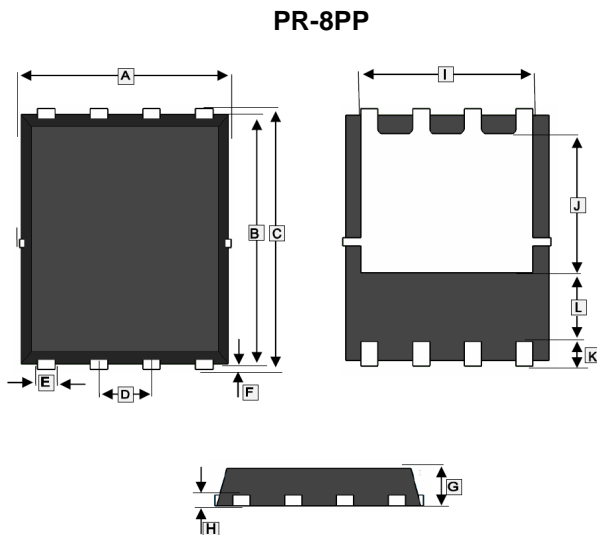
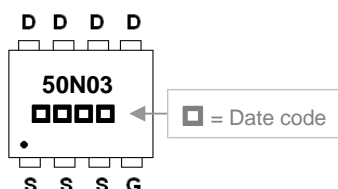

REF.	Millimeter		REF.	Millimeter	
	Min.	Max.		Min.	Max.
A	4.9	5.1	G	0.8	1.0
B	5.7	5.9	H	0.254 Ref.	
C	5.95	6.2	I	4.0 Ref.	
D	1.27 BSC.		J	3.4 Ref.	
E	0.35	0.49	K	0.6 Ref.	
F	0.1	0.2	L	1.4 Ref.	

PACKAGE INFORMATION

Package	MPQ	Leader Size
PR-8PP	3K	13 inch

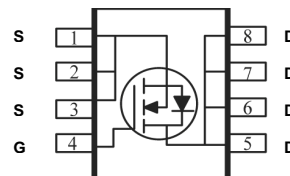

ABSOLUTE MAXIMUM RATINGS ($T_A=25^\circ\text{C}$ unless otherwise specified)

Parameter	Symbol	Rating	Unit
Drain-Source Voltage	V_{DS}	30	V
Gate-Source Voltage	V_{GS}	± 20	V
Continuous Drain Current ¹ @ $V_{GS}=10\text{V}$	I_D	$T_C=25^\circ\text{C}$	51
		$T_C=100^\circ\text{C}$	36
		$T_A=25^\circ\text{C}$	12
		$T_A=70^\circ\text{C}$	9.6
Pulsed Drain Current ²	I_{DM}	130	A
Single Pulse Avalanche Energy ³	EAS	130	mJ
Avalanche Current	I_{AS}	34	A
Power Dissipation ⁴	P_D	46	W
Operating Junction & Storage Temperature	T_J, T_{STG}	-55~150	$^\circ\text{C}$
Thermal Resistance Rating			
Thermal Resistance Junction-Ambient ¹ (Max).	$R_{\theta JA}$	62	$^\circ\text{C} / \text{W}$
Thermal Resistance Junction-Case ¹ (Max).	$R_{\theta JC}$	2.7	$^\circ\text{C} / \text{W}$

ELECTRICAL CHARACTERISTICS ($T_J = 25^\circ\text{C}$ unless otherwise specified)

Parameter	Symbol	Min.	Typ.	Max.	Unit	Test Conditions
Static						
Drain-Source Breakdown Voltage	BV_{DSS}	30	-	-	V	$V_{GS}=0, I_D=250\mu\text{A}$
Gate-Threshold Voltage	$V_{GS(th)}$	1	-	2.5	V	$V_{DS}=V_{GS}, I_D=250\mu\text{A}$
Forward Transconductance	g_{fs}	-	42	-	S	$V_{DS}=5\text{V}, I_D=30\text{A}$
Gate-Source Leakage Current	I_{GSS}	-	-	± 100	nA	$V_{GS} = \pm 20\text{V}$
Drain-Source Leakage Current	I_{DSS}	-	-	1	uA	$V_{DS}=24\text{V}, V_{GS}=0, T_J=25^\circ\text{C}$
		-	-	5		$V_{DS}=24\text{V}, V_{GS}=0, T_J=55^\circ\text{C}$
Static Drain-Source On-Resistance ²	$R_{DS(ON)}$	-	-	9	mΩ	$V_{GS}=10\text{V}, I_D=30\text{A}$
		-	-	13.5		$V_{GS}=4.5\text{V}, I_D=15\text{A}$
Gate Resistance	R_g	-	2.1	3.5	Ω	$f=1.0\text{MHz}$
Total Gate Charge	Q_g	-	10.6	-	nC	$I_D=15\text{A}$ $V_{DS}=15\text{V}$ $V_{GS}=4.5\text{V}$
Gate-Source Charge	Q_{gs}	-	4.2	-		
Gate-Drain ("Miller") Charge	Q_{gd}	-	4	-		
Turn-on Delay Time ²	$T_{d(on)}$	-	6.4	-	nS	$V_{DD}=15\text{V}$ $I_D=15\text{A}$ $V_{GS}=10\text{V}$ $R_G=3.3\Omega$
Rise Time	T_r	-	70.6	-		
Turn-off Delay Time	$T_{d(off)}$	-	22.4	-		
Fall Time	T_f	-	8	-		
Input Capacitance	C_{iss}	-	1127	-	pF	$V_{GS}=0$ $V_{DS}=15\text{V}$ $f=1.0\text{MHz}$
Output Capacitance	C_{oss}	-	194	-		
Reverse Transfer Capacitance	C_{rss}	-	77	-		
Guaranteed Avalanche Characteristics						
Single Pulse Avalanche Energy ⁵	EAS	45	-	-	mJ	$V_{DD}=25\text{V}, L=0.1\text{mH}, I_{AS}=20\text{A}$
Source-Drain Diode						
Diode Forward Voltage ²	V_{SD}	-	-	1	V	$I_S=1\text{A}, V_{GS}=0\text{V}$
Continuous Source Current ^{1,6}	I_S	-	-	51	A	$V_G=V_D=0, \text{Force Current}$
Pulsed Source Current ^{2,6}	I_{SM}	-	-	130	A	
Reverse Recovery Time	T_{rr}	-	12	-	nS	$I_F=30\text{A}, dI/dt=100\text{A}/\mu\text{S}, T_J=25^\circ\text{C}$
Reverse Recovery Charge	Q_{rr}	-	3.7	-	nC	

Note:

- The data tested by surface mounted on a 1 inch2 FR-4 board with 20Z copper , $\leq 10\text{sec}$, $125^\circ\text{C}/\text{W}$ at steady state
- The data tested by pulsed , pulse width $\leq 300\mu\text{s}$, duty cycle $\leq 2\%$
- The EAS data shows Max. rating . The test condition is $V_{DD}=25\text{V}, V_{GS}=10\text{V}, L=0.1\text{mH}, I_{AS}=34\text{A}$
- The power dissipation is limited by 150°C juncti on temperature
- The Min. value is 100% EAS tested guarantee.
- The data is theoretically the same as I_D and I_{DM} , in real applications , should be limited by total power dissipation.

CHARACTERISTIC CURVES

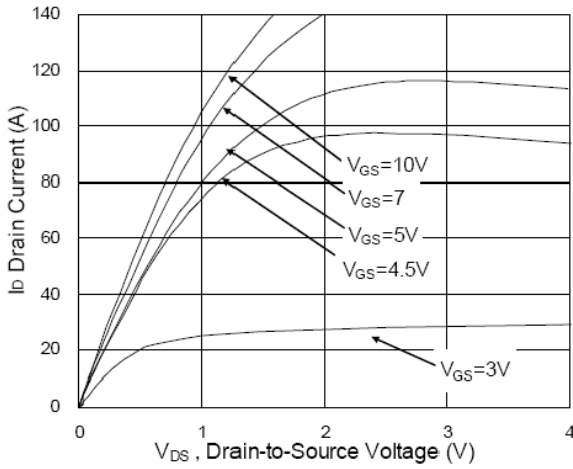

Fig.1 Typical Output Characteristics

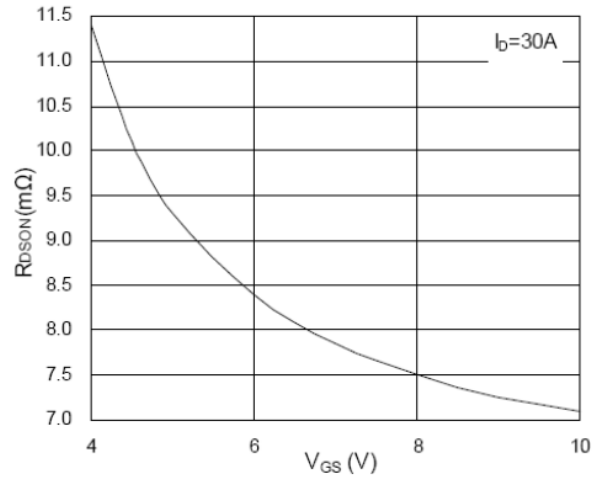

Fig.2 On-Resistance vs. Gate-Source

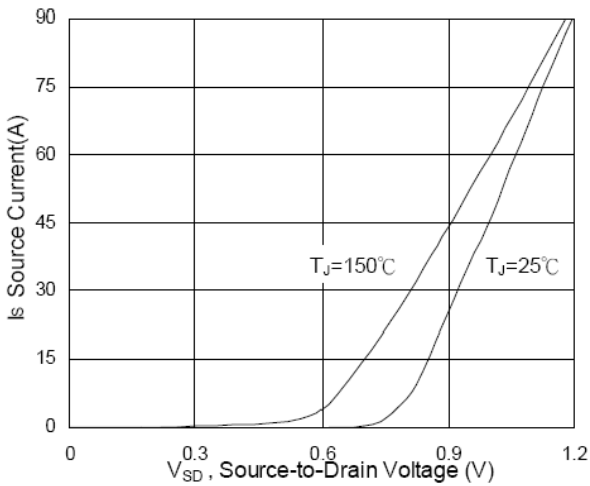

Fig.3 Forward Characteristics of Reverse

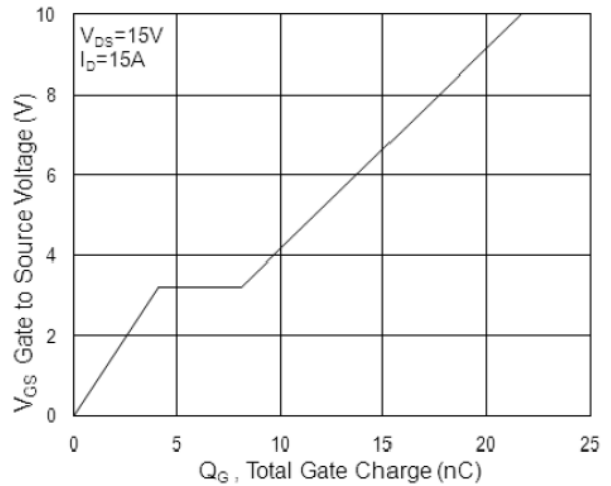

Fig.4 Gate-Charge Characteristics

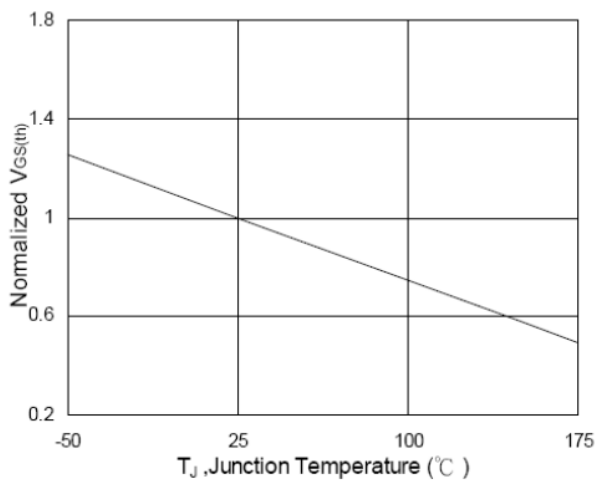

Fig.5 Normalized $V_{GS(th)}$ vs. T_J

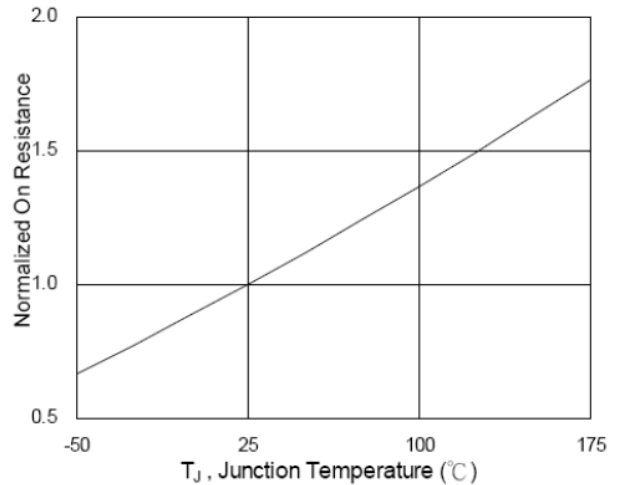

Fig.6 Normalized $R_{DS(on)}$ vs. T_J

CHARACTERISTIC CURVES

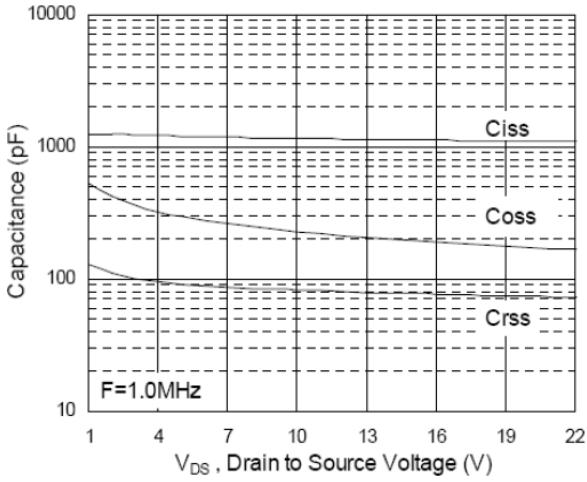

Fig.7 Capacitance

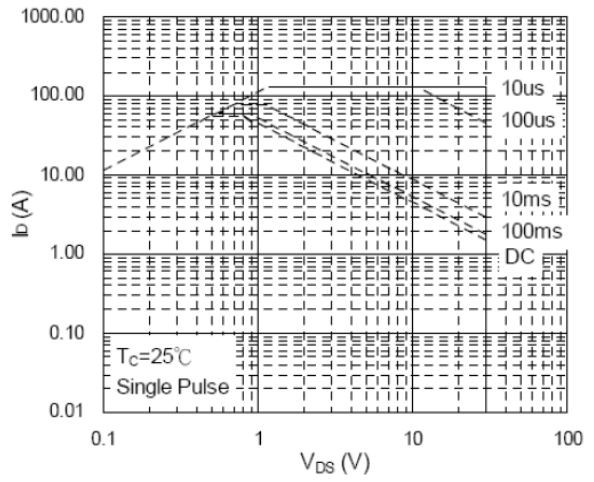

Fig.8 Safe Operating Area

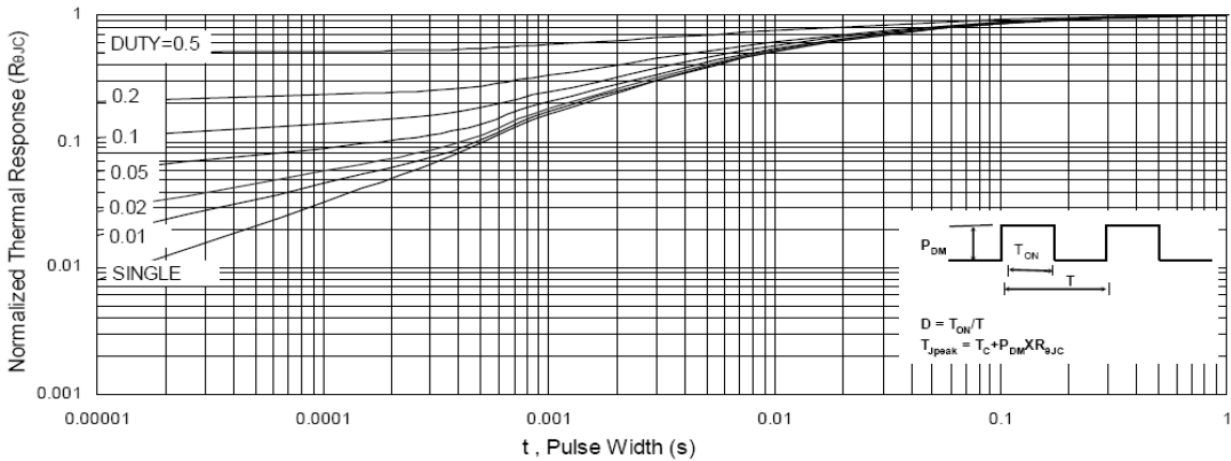

Fig.9 Normalized Maximum Transient Thermal Impedance

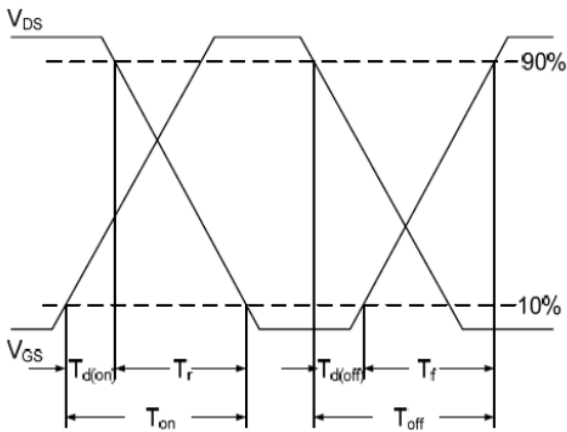

Fig.10 Switching Time Waveform

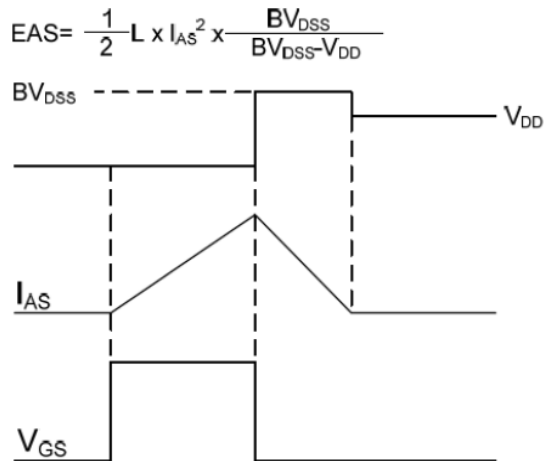

Fig.11 Unclamped Inductive Switching Waveform