

150mA Low Dropout Voltage Regulator

FEATURES

- 5.0V and 3.3V output versions
- 1% Output Accuracy
- Very Low Quiescent Current
- Low Dropout: 300mV @ 150mA
- Very Tight Load & Line Regulation
- Very Low Temperature Coefficient
- Current and Thermal Limiting
- Requires only 1μF for Stability
- Equivalent Replacement for LT1121
- Industry Standard SOT-223 and TO-92 3 lead packages

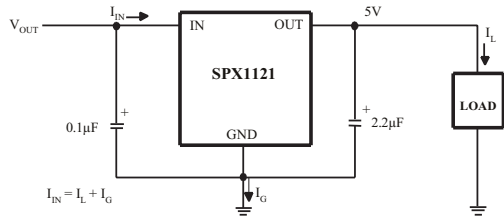
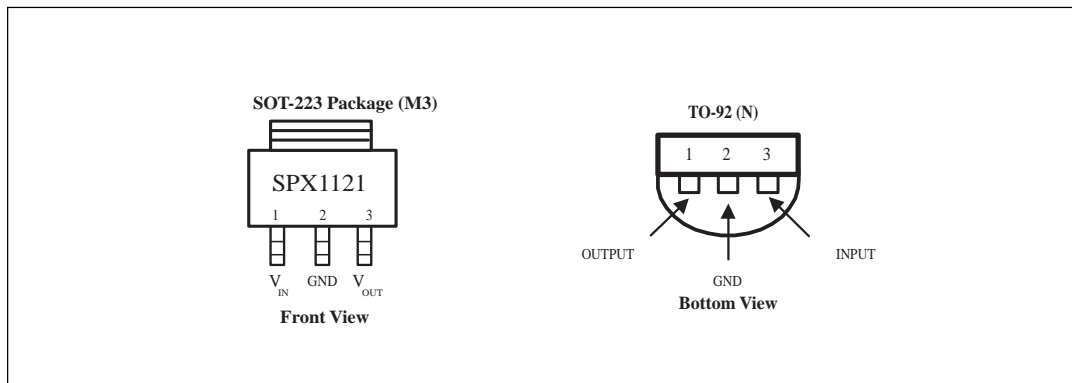

Figure 1. Fixed +5V Regulator Circuit

DESCRIPTION

The SPX1121 is a low power voltage regulator. It is an excellent choice for use in battery-powered applications such as cordless telephones, radio control systems, and portable computers. The SPX1121 features very low quiescent current and low dropout voltage (typ. 20mV at 100μA and 300mV at 150mA). A tight initial tolerance (1%), extremely good load and line regulation (0.05% typ.), and very low output temperature coefficient (20 ppm/°C typ.), make the SPX1121 useful as a low power voltage reference.

PACKAGES



ABSOLUTE MAXIMUM RATINGS

Power Dissipation.....Internally Limited
 Lead Temperature (soldering, 5 seconds)260°C
 Storage Temperature Range.....-65°C to +150°C

Operating Junction Temperature Range.....-40°C to +125°C
 Input Supply Voltage.....-0.3V to +30V
 ESD Rating.....2kV min

ELECTRICAL CHARACTERISTICS $V_{IN}=6V$, $I_L=100\mu A$, $C_L=1\mu F$ (NOTE 2), $T_A = 25^\circ C$, unless otherwise specified. Boldface applies over the full operating temperature ranges.

PARAMETER	CONDITIONS	MIN.	TYP.	MAX	UNIT
3.3 V Versions					
Output Voltage	$T_J=25^\circ C$ $1mA \leq I_L \leq 150 mA$	3.267 3.217	3.300 3.300	3.333 3.382	V
5 V Versions					
Output Voltage	$T_J = 25^\circ C$ $1 mA \leq I_L \leq 150 mA$	4.950 4.880	5.000 5.000	5.050 5.120	V
All Voltage Options					
Output Voltage Temperature Coefficient	(NOTE 1)		20	100	ppm/°C
Line Regulation (NOTE 3)	$6V \leq V_{IN} \leq 30V$ (NOTE 4)		0.03	0.20	%
Load Regulation (NOTE 3)	$100 \mu A \leq I_L \leq 150 mA$		0.04	0.60	%
Dropout Voltage (NOTE 5)	$I_L = 100\mu A$ $I_L = 1mA$ $I_L = 100 mA$ $I_L = 150 mA$		20 110 270 300	550	mV
Ground Current	$I_L = 100\mu A$ $I_L = 1mA$ $I_L = 10mA$		100 110 350	170	μA
	$I_L = 50mA$ $I_L = 100 mA$ $I_L = 150 mA$		1 3 5	6 10	mA
Current Limit	$V_{OUT} = 0$		230	500	mA
Thermal Regulation			0.05	0.20	%/W
Output Noise, 10Hz to 100kHz	$C_L = 1\mu F$ $C_L = 200 \mu F$		430 160		μV rms μV rms

NOTE 1: Output or reference voltage temperature coefficients defined as the worst case voltage change divided by the total temperature range.

NOTE 2: Unless otherwise specified all limits guaranteed for $T_J = 25^\circ C$, $V_{IN} = 6V$, $I_L = 100\mu A$ and $C_L = 1\mu F$.

NOTE 3: Regulation is measured at constant junction temperature, using pulse testing with a low duty cycle. Changes in output voltage due to heating effects are covered under the specification for thermal regulation.

NOTE 4: Line regulation for the SPX1121 is tested at $I_L = 1mA$. For $T_J = 125^\circ C$, line regulation is guaranteed by design. See typical performance characteristics for line regulation versus temperature and load current.

NOTE 5: Dropout voltage is defined as the input to output differential at which the output voltage drops 100 mV below its nominal value measured at 1V differential.

TYPICAL PERFORMANCE CHARACTERISTICS

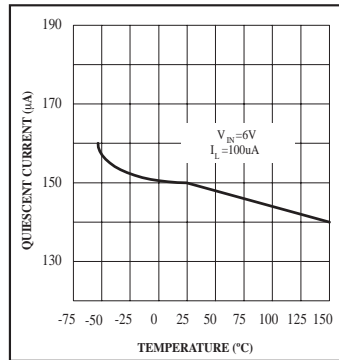
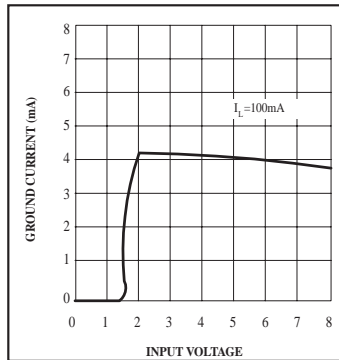
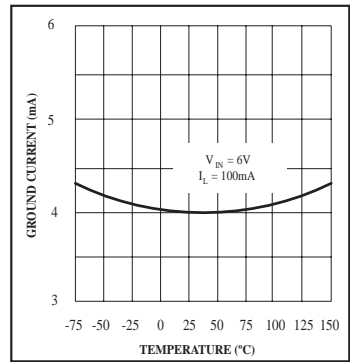
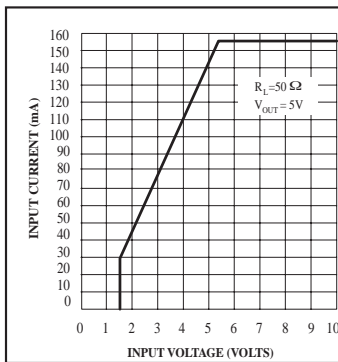
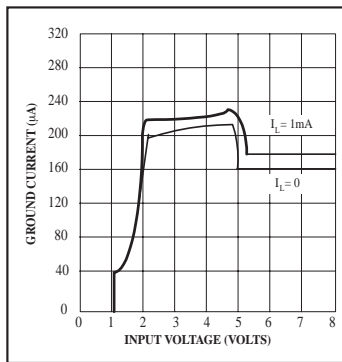
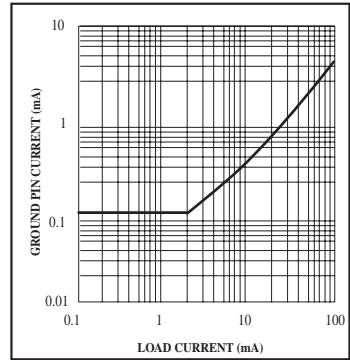
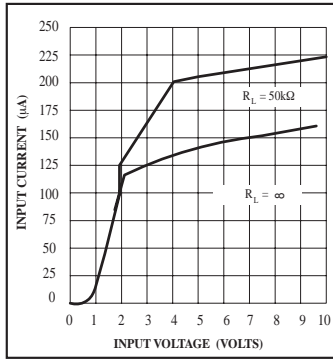
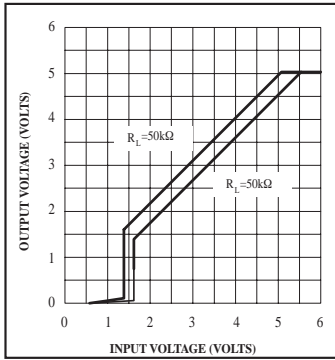

TYPICAL PERFORMANCE CHARACTERISTICS

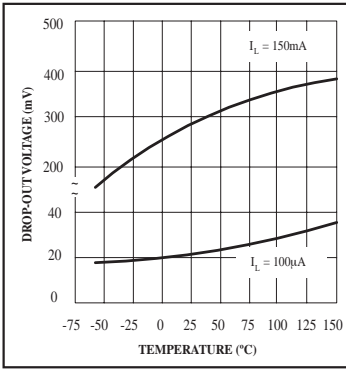

Drop-Out Voltage

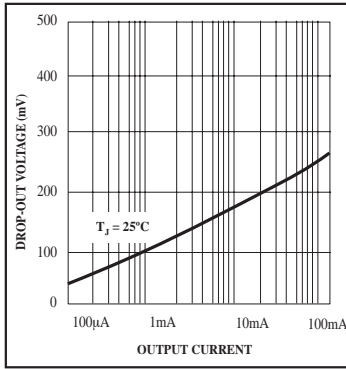

Drop-Out Voltage

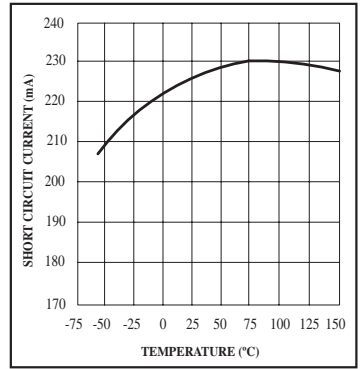

Short Circuit Current

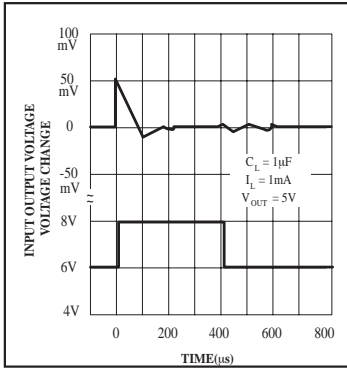

Line Transient Response

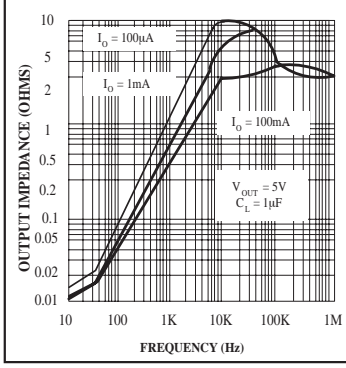

Output Impedance

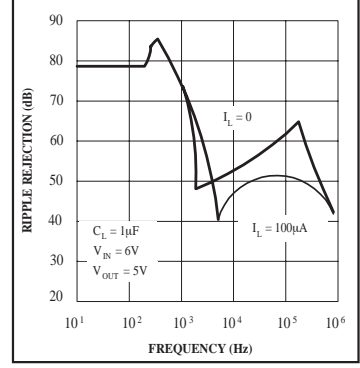

Ripple Rejection

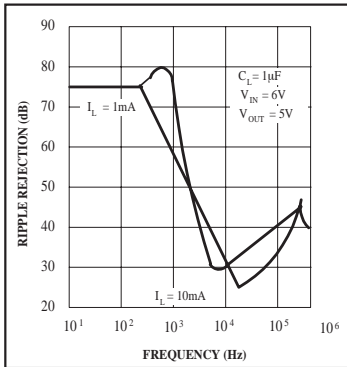

Ripple Rejection

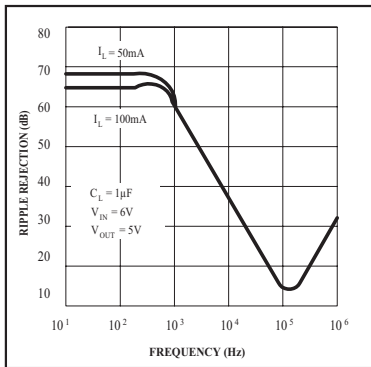

Ripple Rejection

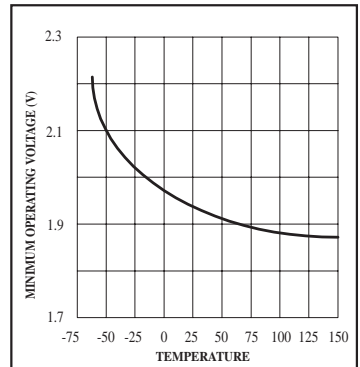

Minimum Operating Voltage

TYPICAL PERFORMANCE CHARACTERISTICS (CONT.)

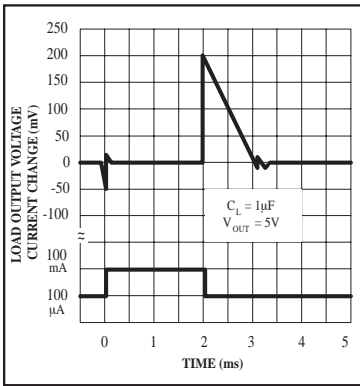

Load Transient Response

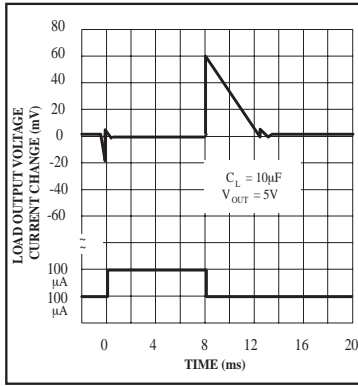

Load Transient Response

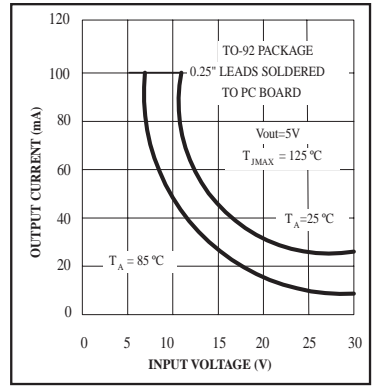

Maximum Rated Output

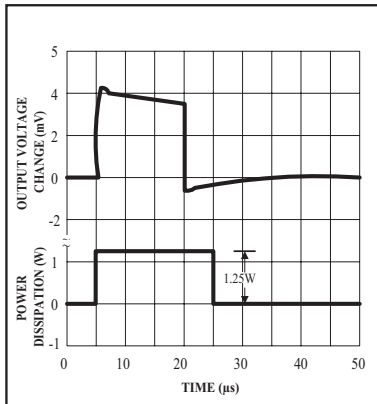

Thermal Response

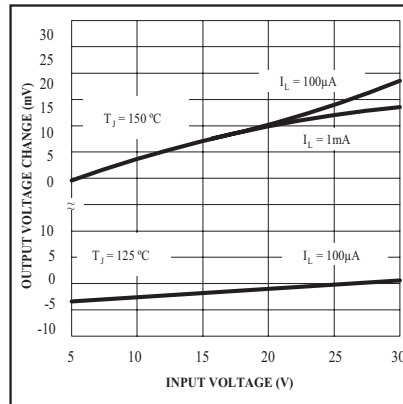

Line Regulation

APPLICATIONS HINTS

EXTERNAL CAPACITORS

The stability of the SPX1121 requires a $1\mu\text{F}$ or greater capacitor between output and ground. Oscillation could occur without this capacitor. Most types of tantalum or aluminum electrolytic works fine here. For operations below -25°C solid tantalum is recommended since the many aluminum types have electrolytes that freeze at about -30°C . The ESR of about 5Ω or less and resonant frequency above 500kHz are the most important parameters in the value of the capacitor. The capacitors value may be increased without limit.

The SPX1121 unlike other low dropout regulators will remain stable and in regulation with no load in addition to the internal voltage divider. This feature is especially important in applications like CMOS RAM keep-alive.

If there is more than 10 inches of wire between the input and the AC filter capacitor or if a battery is used as the input then a $0.1\mu\text{F}$ tantalum or aluminum electrolytic capacitor should be placed from the input to the ground.

REDUCING OUTPUT NOISE

It may be an advantage to reduce the AC noise present at the output. One way is to reduce the regulator bandwidth by increasing the size of the output capacitor. Increasing the capacitor from $1\mu\text{F}$ to $220\mu\text{F}$ decreases the noise from $430\mu\text{V}$ to $160\mu\text{VRMS}$ for a 100kHz bandwidth at 5V output.

PACKAGE: 3 Lead SOT-223

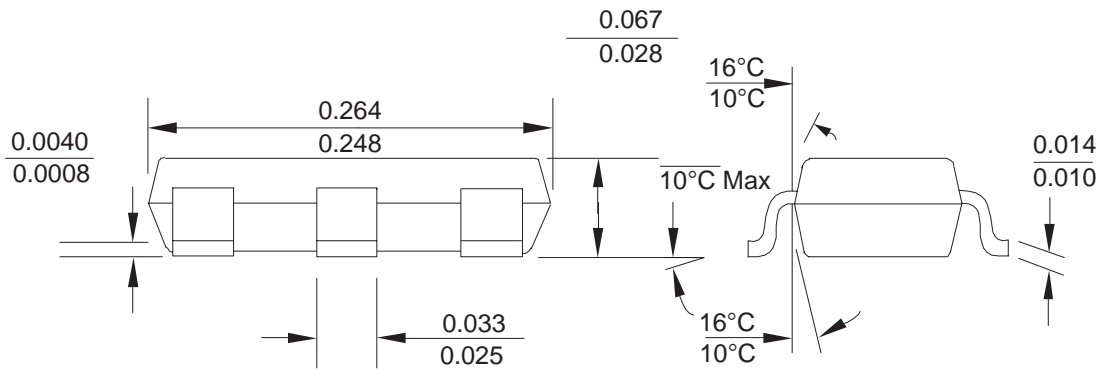
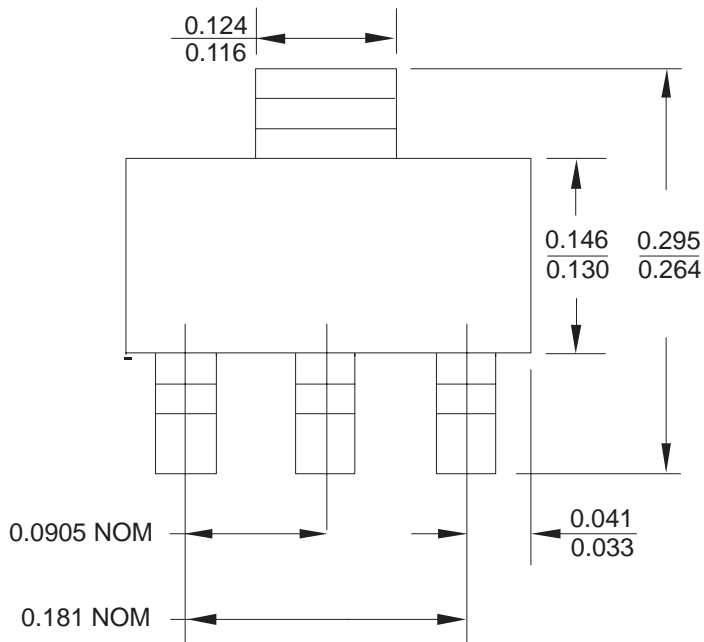

PACKAGE: TO-92

0.090 (2.286) Radius typ.

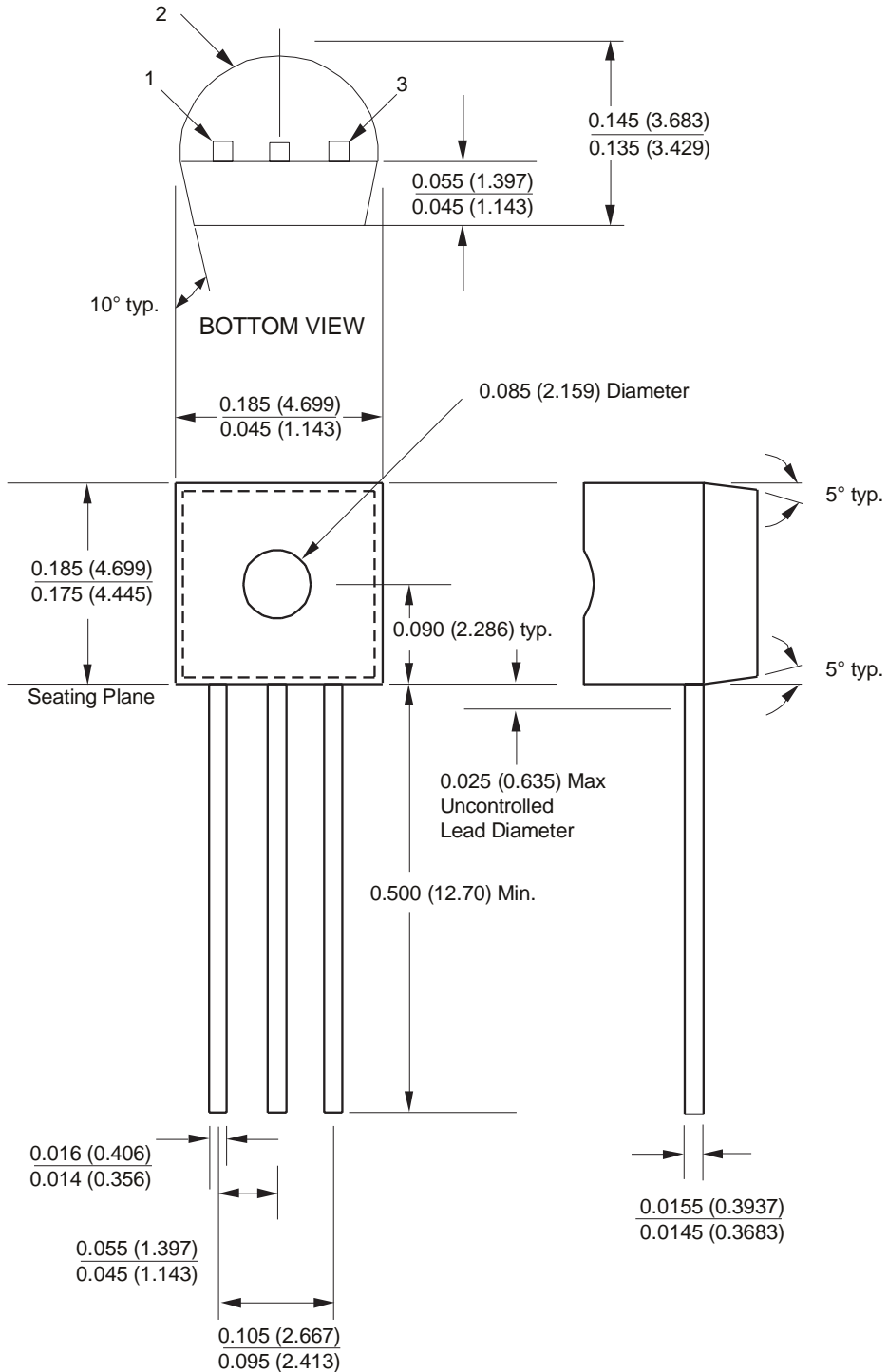

ORDERING INFORMATION

PART NUMBER	ACCURACY	OUTPUT VOLTAGE	PACKAGE
SPX1121N-3.3	1%	3.3V	3 lead TO-92
SPX1121N-5.0	1%	5.0V	3 lead TO-92
SPX1121M3-3.3	1%	3.3V	3 lead SOT-223
SPX1121M3-5.0	1%	5.0V	3 lead SOT-223

Please consult the factory for pricing and availability on a Tape-On-Reel option.



SIGNAL PROCESSING EXCELLENCE

Sipex Corporation

Headquarters and Sales Office

233 South Hillview Drive
Milpitas, CA 95035
TEL: (408) 934-7500
FAX: (408) 935-7600

Sales Office

22 Linnell Circle
Billerica, MA 01821
TEL: (978) 667-8700
FAX: (978) 670-9001
e-mail: sales@sipex.com

Sipex Corporation reserves the right to make changes to any products described herein. Sipex does not assume any liability arising out of the application or use of any product or circuit described herein; neither does it convey any license under its patent rights nor the rights of others.