



SANYO Semiconductors

DATA SHEET

SR10000 Series — Ultrathin Miniature Package 1-channel Step-up DC/DC Converter ICs

Overview

The SR10000 Series is a SANYO's original SIP (System In Package) that includes a DC/DC converter control IC, a power MOSFET and a Schottky barrier diode. All these components are mounted into one thin-and-small package by utilizing SANYO's high-density mounting technology, "Integrated System in Board (ISB)".

The advantage using this DC/DC converter package is that it greatly decreases its mounting area and space, compared with when the same circuit is set up with the discrete devices. In addition to that, it is very easy to assemble step-up switching power supply with by just adding voltage-setting resistance, inductor and capacitors.

Functions and Features

- Since the SR10000 Series packages a voltage step-up DC/DC converter IC as well as power MOSFET and Schottky barrier diode devices in the same package with the minimum trace length between components, it can provide high efficiency and superior characteristics including low output ripple. In particular the mounting area required by these components is reduced when compared to implementations using discrete devices.
- The output voltage is set using an external resistor.
- Standby function: Standby mode current=1μA (maximum)
- Automatic PWM/PFM switching control (SR10020, SR10040, SR10050)
- External PWM/PFM switching control (SR10030, SR10060, SR10070)
- Oscillator frequency: 100kHz (SR10060), 180kHz (SR10030), 300kHz (SR10020, SR10070), 500kHz (SR10040, SR10050) (accuracy±15%)

- The values given in this data sheet for models SR10060 is tentative and subject to change before putting into mass production.

■ Any and all SANYO Semiconductor products described or contained herein do not have specifications that can handle applications that require extremely high levels of reliability, such as life-support systems, aircraft's control systems, or other applications whose failure can be reasonably expected to result in serious physical and/or material damage. Consult with your SANYO Semiconductor representative nearest you before using any SANYO Semiconductor products described or contained herein in such applications.

■ SANYO Semiconductor assumes no responsibility for equipment failures that result from using products at values that exceed, even momentarily, rated values (such as maximum ratings, operating condition ranges, or other parameters) listed in products specifications of any and all SANYO Semiconductor products described or contained herein.

SANYO Semiconductor Co., Ltd.

TOKYO OFFICE Tokyo Bldg., 1-10, 1 Chome, Ueno, Taito-ku, TOKYO, 110-8534 JAPAN

SR10000 Series

Comparison of Functions

Type No.	DC/DC Controller IC			TR Maximum Rating		Di Maximum Rating		Output Setting *1
	Control System	Input Voltage Range	Oscillator Frequency	V _{DSS}	I _D	V _{RRM}	I _O	
SR10020	Automatic PWM/PFM switching control	0.9V to 10V	300kHz	30V	2.5A	30V	1A	1.5V to 20V
SR10030	External PWM/PFM switching control	0.9V to 10V	180kHz	30V	2.5A	30V	1A	1.5V to 20V
SR10040	Automatic PWM/PFM switching control	0.9V to 10V	500kHz	30V	2.5A	30V	1A	1.5V to 20V
SR10050	Automatic PWM/PFM switching control	0.9V to 10V	500kHz	30V	2.5A	15V	2A	1.5V to 10V
SR10060	External PWM/PFM switching control	0.9V to 10V	100kHz	20V	3A	30V	1A	1.5V to 13V
SR10070	External PWM/PFM switching control	0.9V to 10V	300kHz	20V	3A	15V	2A	1.5V to 10V

*1: The output setting maximum values are voltages that are 1/1.5 times the V_{DSS} and V_{RRM} as a general rule of thumb, and they are provided to serve as a reference only. As such, it must be verified during actual operation that they do not exceed the rated voltages.

Package Dimensions

unit : mm

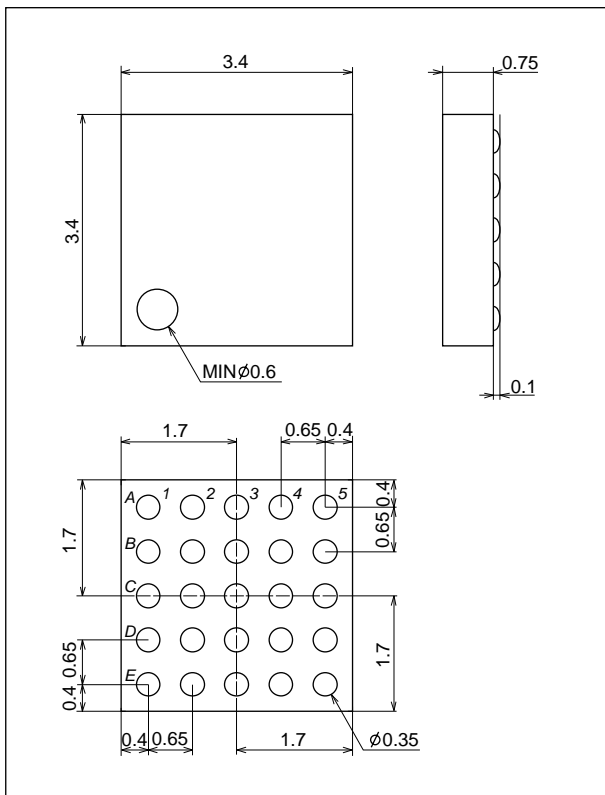

SR10000 Series

Pin Layout and Internal Equivalent Circuit Block Diagram

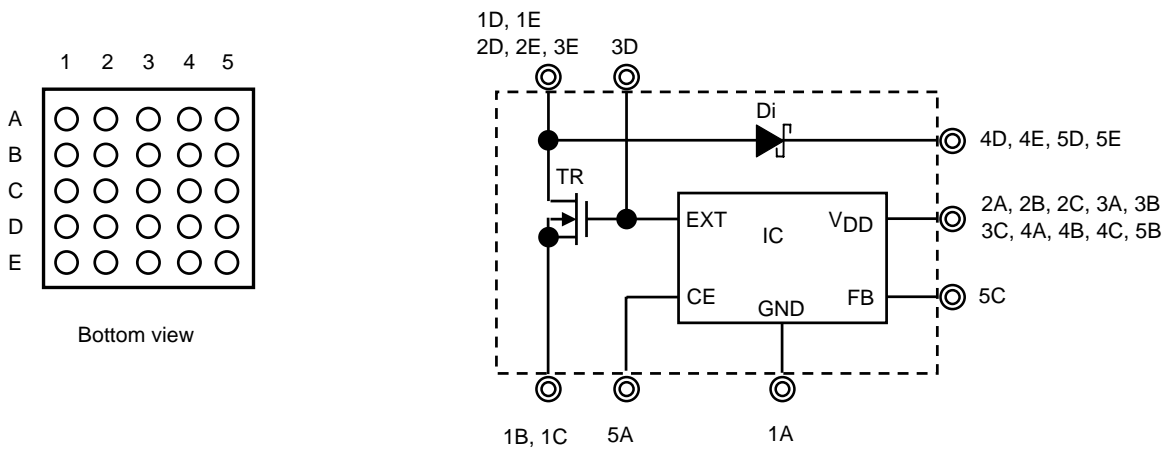

Specifications

Absolute Maximum Ratings at $T_a = 25^\circ\text{C}$

Device	Parameter	Symbol	Conditions	Ratings	Unit
IC	V_{DD} pin voltage	V_{DD}		-0.3 to +12	V
	FB pin voltage	V_{FB}		-0.3 to +12	V
	CE pin voltage	V_{CE}		-0.3 to +12	V
	EXT pin voltage	V_{EXT}		-0.3 to $V_{DD}+0.3$	V
	EXT pin current	I_{EXT}		± 100	mA
TR	Drain-to-source voltage 1	V_{DSS1}	SR10020, SR10030, SR10040, SR10050	30	V
	Gate-to-source voltage 1	V_{GSS1}		± 12	V
	Drain current 1	I_{D1}		2.5	A
	Drain-to-source voltage 2	V_{DSS2}	SR10060, SR10070	20	V
	Gate-to-source voltage 2	V_{GSS2}		± 10	V
	Drain current 2	I_{D2}		3	A
	Allowable power dissipation	P_{D-T}	60mm×60mm×1.6mm ³ FR4 board	700	mW
Di	Reverse voltage 1	V_{RRM1}	SR10020, SR10030, SR10040, SR10060	30	V
	Output current 1	I_{O1}		1	A
	Reverse voltage 2	V_{RRM2}	SR10050, SR10070	15	V
	Output current 2	I_{O2}		2	A
	Allowable power dissipation	P_{D-D}	60mm×60mm×1.6mm ³ FR4 board	750	mW
Operating temperature		T_{opr}		-30 to +85	$^\circ\text{C}$
Storage temperature		T_{stg}		-40 to +125	$^\circ\text{C}$

SR1000 Series

Electrical Characteristics

Overall Operating Characteristics at $T_a = 25^\circ\text{C}$, in the specified test circuit

Parameter	Symbol	Conditions	Ratings			Unit
			min	typ	max	
Output voltage	V_{OUT}	$V_{IN}=2\text{V}, I_O=10\text{mA}$	3.217	3.300	3.383	V
Output voltage setting range	VOSET	$V_{IN}=\text{VOSET} \times 0.6, V_{DD}=3.3\text{V}, I_{OUT}=10\text{mA}$	1.5		*2	V
FB control voltage	VFB			0.9		V
Supply voltage	V_{DD}	*3	1.8		10	V
Operation start voltage	VST	$I_O=1\text{mA}$			0.9	V
Current dissipation	I_{DD}	$V_{IN}=2\text{V}, I_O=0\text{mA}$ SR10060		29	41	μA
		$V_{IN}=2\text{V}, I_O=0\text{mA}$ SR10030		45	64	μA
		$V_{IN}=2\text{V}, I_O=0\text{mA}$ SR10020, SR10070		62	88	μA
		$V_{IN}=2\text{V}, I_O=0\text{mA}$ SR10040, SR10050		97	137	μA
Standby current	ISTB	$V_{IN}=2\text{V}, V_{CE}=0\text{V}$			1	μA
Oscillator frequency	FOSC	$V_{IN}=2\text{V}, I_O=10\text{mA}$ SR10060	85	100	115	kHz
		$V_{IN}=2\text{V}, I_O=10\text{mA}$ SR10030	153	180	207	kHz
		$V_{IN}=2\text{V}, I_O=10\text{mA}$ SR10020, SR10070	255	300	345	kHz
		$V_{IN}=2\text{V}, I_O=10\text{mA}$ SR10040, SR10050	425	500	575	kHz
Efficiency	EFFI			85		%
CE high voltage	VCEH		0.65			V
CE low voltage	VCEL				0.20	V
PWM high voltage	VPWMH	SR10030, SR10060, SR10070 *4	$V_{DD}-0.2$			V
PWM low voltage	VPWML	SR10030, SR10060, SR10070 *4			$V_{DD}-1.0$	V
CE high current	ICEH	$CE=V_{DD}=3.3\text{V}$			0.1	μA
CE low current	ICEL	$CE=0\text{V}$			0.1	μA

*2: The output setting maximum voltages are within 1/1.5 times the V_{DSS} of the built-in MOSFET and within 1/1.5 times the V_{RRM} of the Di as a general rule of thumb. As such, it must be verified during actual operation that they do not exceed the rated voltages.

*3: V_{DD} should be 1.8V or higher when V_{IN} or other power source is supplying V_{DD} since the output voltage and oscillating frequency become steady when V_{DD} is set 1.8V or higher, although the built-in IC starts step-up voltage operation from $V_{DD}=0.8\text{V}$.

*4: For models SR10030, SR10060, and SR10070, the CE pin also serves to implement a PWM/PFM external switching function. When the voltage is $V_{DD}-0.2\text{V}$ or more, PWM control is exercised, and when it is VCEH or more but $V_{DD}-1.0\text{V}$ or less, PWM/PFM automatic switching at a duty ratio of 25% is controlled.

Di Characteristics at $T_a = 25^\circ\text{C}$, in the specified test circuit

Parameter	Symbol	Conditions	min	typ	max	unit
Forward voltage 1	VF1	SR10020, SR10030		0.43	0.47	V
Reverse current 1	IR1	SR10040, SR10060		40	200	μA
Forward voltage 2	VF2	SR10050, SR10070		0.30	0.35	V
Reverse current 2	IR2				600	μA

Pin Functions

Pin No.	Pin Name	Description
1A	GND	Ground pin for IC.
1B, 1C	TR Source	Source pin for TR
1D, 1E, 2D, 2E, 3E	TR Drain, Di Anode	Drain of TR and Anode of Diode
2A, 2B, 2C, 3A, 3B, 3C 4A, 4B, 4C, 5B	IC V_{DD}	Supply voltage for IC
3D	IC EXT, TR Gate	Gate for TR
4D, 4E, 5D, 5E	Di Cathode	Cathode of Diode and V_{OUT}
5A	IC CE	Operation starts when chip enable pin is set to "high". This pin also serves as a PWM/PFM selector for models SR10030, SR10060, and SR10070.
5C	IC FB	External resistance connecting pin for output voltage setting, internal control voltage: 0.9V typical

Equivalent Circuit and Test Peripheral Circuitry

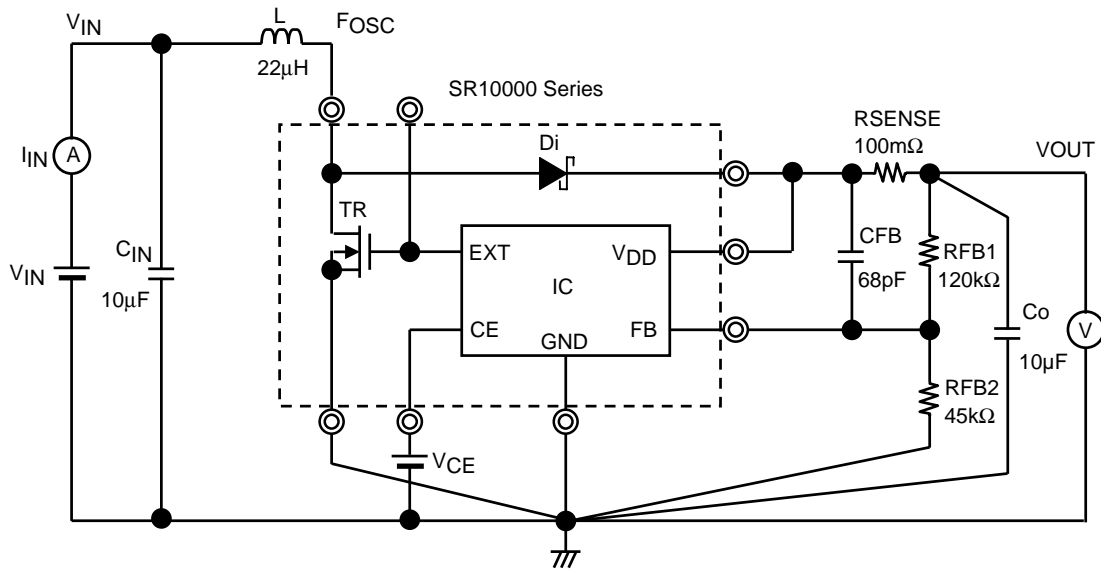

Selection rules of external components

- 1) RFB: Set the ratio of RFB1 and RFB2 to be $RFB1+RFB2 \leq 2M\Omega$ and $V_{FB}=0.9V$.
- 2) CFB: Set $f_{zfb}=1/(2 \times \pi \times CFB \times RFB1)$ to be within 5kHz to 30kHz.
- 3) L, C_o, RSENSE:

When ceramic capacitor is used for C_o: L=10µH, C_o=10µF (SR10020, SR10040, SR10050, SR10070)

L=22µH, C_o=10µF (SR10030, SR10060)

RSENSE=50mΩ (SR10060), 100mΩ (other than SR10060)

When tantalum capacitor is used for C_o: L=10µH, C_o=47µF (SR10040, SR10050)

L=22µH, C_o=47µF (SR10020, SR10070)

L=47µH, C_o=47µF (SR10030, SR10060)

RSENSE=None (shorted)

When electrolytic capacitor is used for C_o: L=22µH, C_o=100µF//2.2µF ceramic (SR10020, SR10070)

L=47µH, C_o=100µF//2.2µF ceramic (SR10030, SR10060)

RSENSE=None (shorted)

These constants of the components above should be changed if necessary for larger step-up ratio V_{OUT}/V_{IN} and larger output current I_{OUT} using the expression shown below as a reference.

$$C_o = (\text{Standard } C_o^*) \times (I_{OUT} \text{ (mA)} / 300\text{mA}) \times V_{OUT}/V_{IN}$$

* Standard C_o: values shown above

SR10000 Series

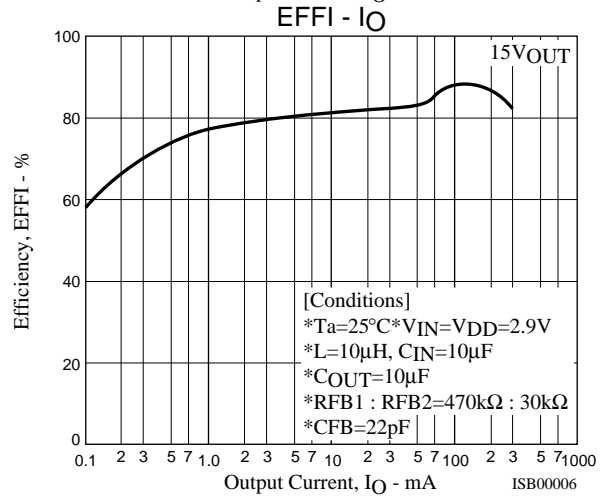
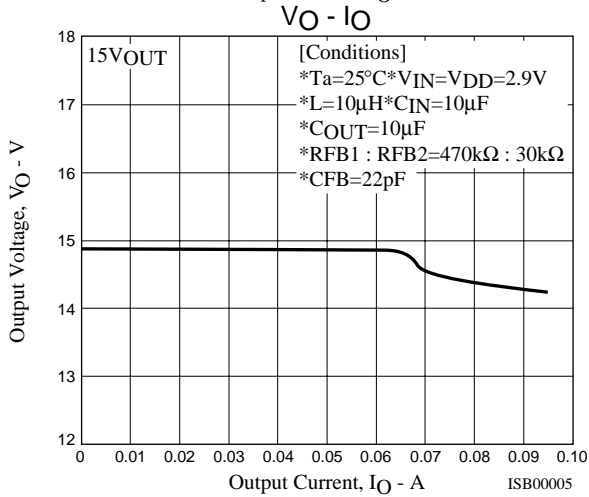
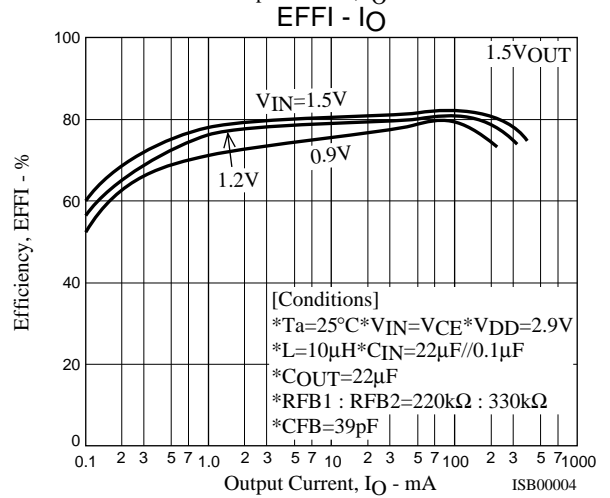
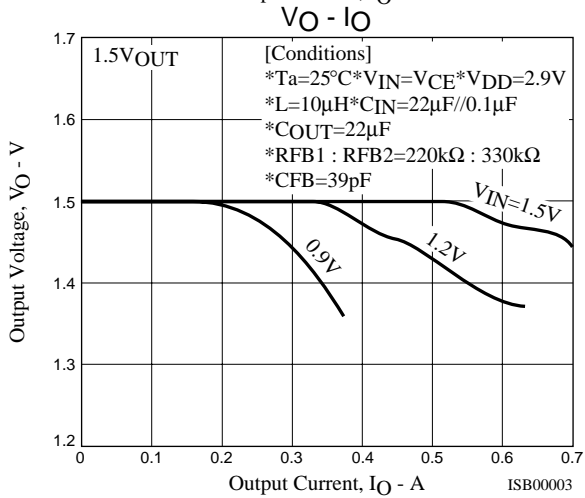
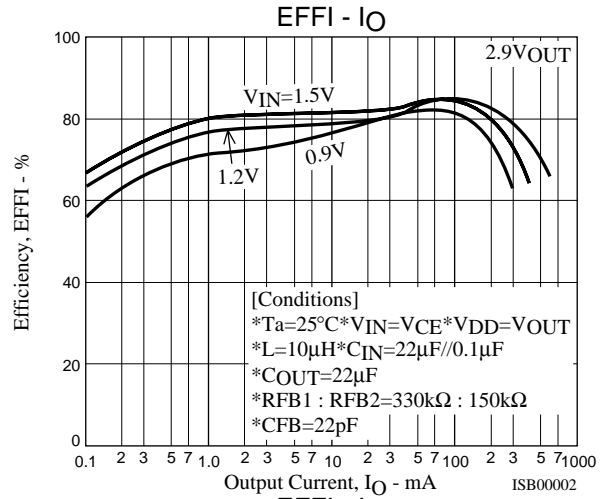
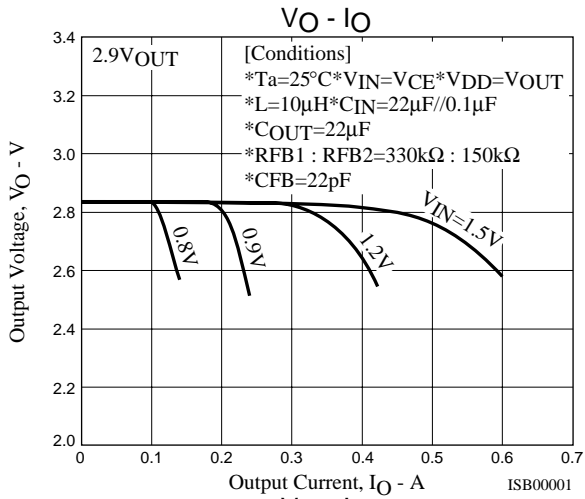

SR1000 Series

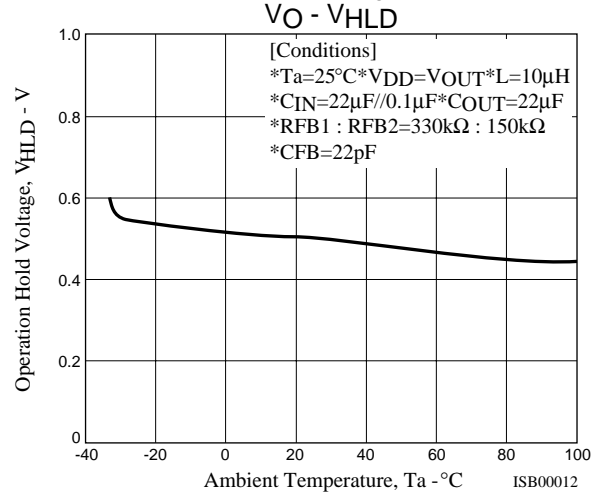
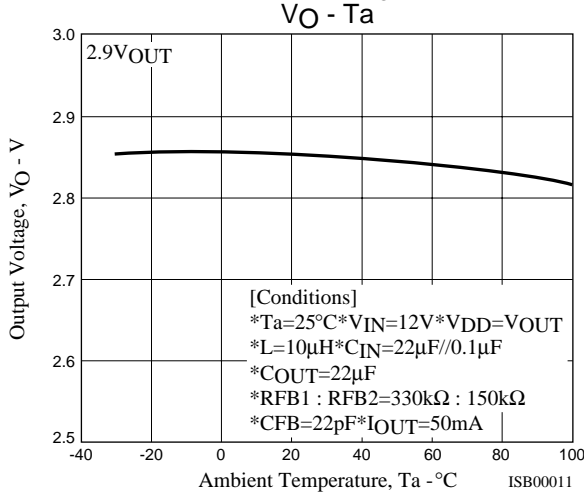
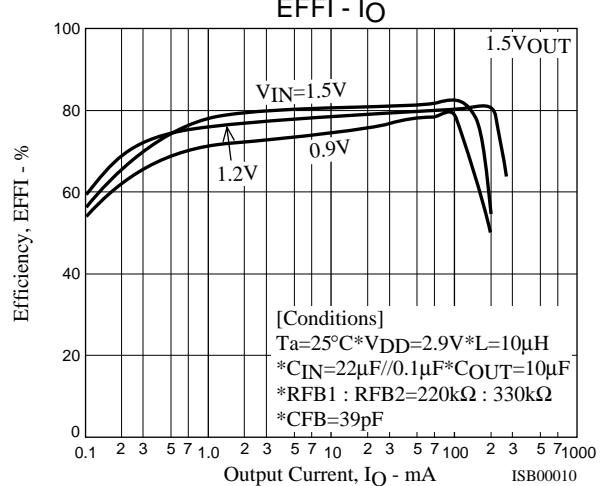
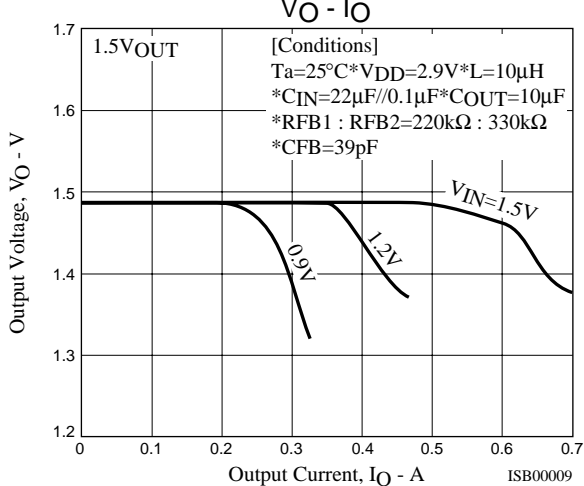
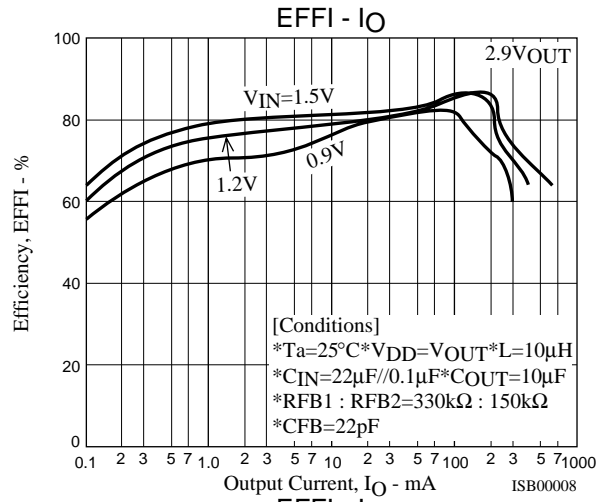
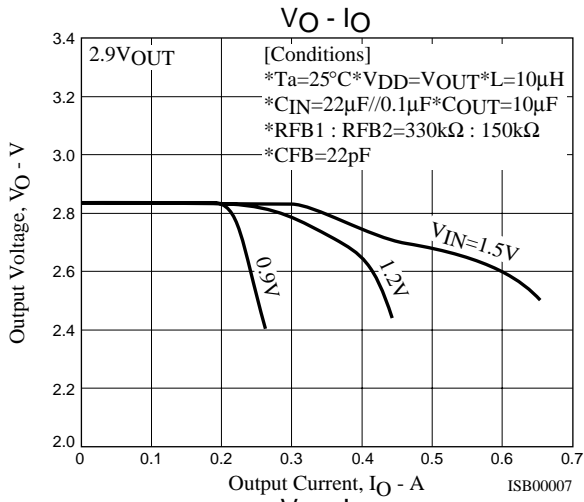

<Manufactured by>

ISB Business Unit, Electronic Device Company,
Component & Device Group, SANYO Electric Co., Ltd.

- Specifications of any and all SANYO Semiconductor products described or contained herein stipulate the performance, characteristics, and functions of the described products in the independent state, and are not guarantees of the performance, characteristics, and functions of the described products as mounted in the customer's products or equipment. To verify symptoms and states that cannot be evaluated in an independent device, the customer should always evaluate and test devices mounted in the customer's products or equipment.
- SANYO Semiconductor Co., Ltd. strives to supply high-quality high-reliability products. However, any and all semiconductor products fail with some probability. It is possible that these probabilistic failures could give rise to accidents or events that could endanger human lives, that could give rise to smoke or fire, or that could cause damage to other property. When designing equipment, adopt safety measures so that these kinds of accidents or events cannot occur. Such measures include but are not limited to protective circuits and error prevention circuits for safe design, redundant design, and structural design.
- In the event that any or all SANYO Semiconductor products (including technical data, services) described or contained herein are controlled under any of applicable local export control laws and regulations, such products must not be exported without obtaining the export license from the authorities concerned in accordance with the above law.
- No part of this publication may be reproduced or transmitted in any form or by any means, electronic or mechanical, including photocopying and recording, or any information storage or retrieval system, or otherwise, without the prior written permission of SANYO Semiconductor Co., Ltd.
- Any and all information described or contained herein are subject to change without notice due to product/technology improvement, etc. When designing equipment, refer to the "Delivery Specification" for the SANYO Semiconductor product that you intend to use.
- Information (including circuit diagrams and circuit parameters) herein is for example only; it is not guaranteed for volume production. SANYO Semiconductor believes information herein is accurate and reliable, but no guarantees are made or implied regarding its use or any infringements of intellectual property rights or other rights of third parties.

This catalog provides information as of April, 2006. Specifications and information herein are subject to change without notice.