

SR 30 SERIES CONNECTORS

Introduction

SR30 series circular connectors are developed for use in the microphone circuitry of compact size wireless communication equipment. Its size is remarkably miniaturized

compared with conventional connectors, offering an attractive contemporary design.

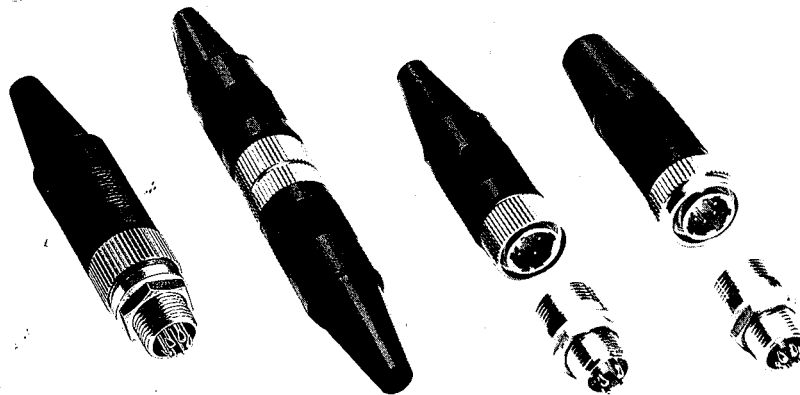

Features

- (1) Compact and light weight maximum outside diameter of $\phi 15$ mm.
- (2) Most suitable for compact electronic devices such as high grade transceivers, ITV cameras, and radio equipment.
- (3) Streamlined design well suited for compact devices.
- (4) Bushings are provided for the cable ends to prevent damage from bending.

Main Specification

Description	Test data
Withstanding voltage	AC 300V for 1 min.
Current capacity	1A
Insulation resistance	200M Ω and more at DC 100V
Contact resistance	10m Ω or less at DC 1A

Part	Material	Finish
Shell	Brass and Zinc alloy	Nickel plated and Chromium plated
Insulator	Polyacetal resin	Glass filled
Male pin	Brass	Gold plated or Silver plated
Female pin	Copper alloy	Gold plated or Silver plated

Plug

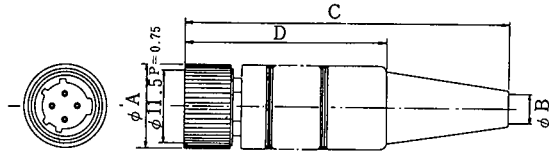
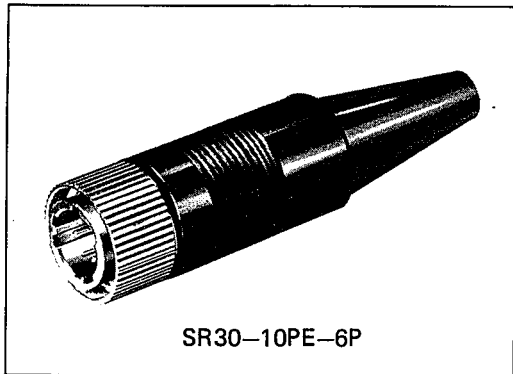

(An example in shape)

Note 1) When ordering the SR30-10PE-6P or SR30-10PX-6P, order SR30-P cable clamps separately, because such plugs have no cable clamps.

Note 2) The inside diameter of the male terminal solder post inside diameter is 0.8 mm.

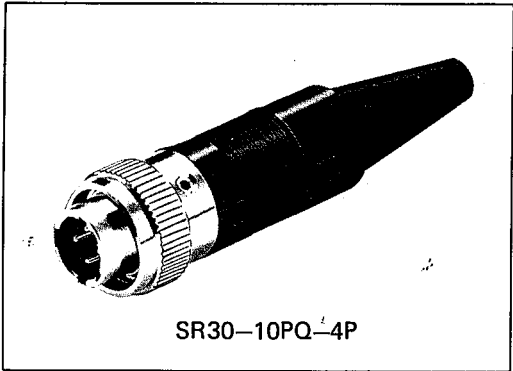

HRS No.	Part No.	No. of pin	φA	φB	C	D	Remarks
103-0265-2	SR30-10PE-4P	4	13	4.3	51.5	32	
103-0258-7	SR30-10PE-6P	6	13	4.3	51.5	32	Note 1
103-0273-0	SR30-10PG-6P	6	13	5.2	49.0	31	
103-0336-9	SR30-10PX-6P	6	13	5.7	49.0	—	Note 1
103-0319-0	SR30-10PF-6P	6	15	5.5	55.0	—	
103-0316-1	SR30-10PF-7P	7	15	5.5	55.0	—	Silver plated
103-0341-9	SR30-10PM-4P	4	15	5.7	49.0	—	
103-0288-8	SR30-10PM-6P	6	15	5.7	49.0	—	
103-0293-8	SR30-10PQ-4P	4	15	4.3	57.5	38	Screw attached
103-0313-3	SR30-10PQ-6P	6	15	4.3	57.5	38	Screw attached
103-0350-0	SR30-10WP-6PA	6	15	4.3	51.5	32	Waterproof
103-0362-9	SR30-10WPA-7P	7	15	5.5	109	—	Waterproof
103-0266-5	SR30-P						Metal clammer

Receptacle (Jam Nut to be fastened)

Solder Type

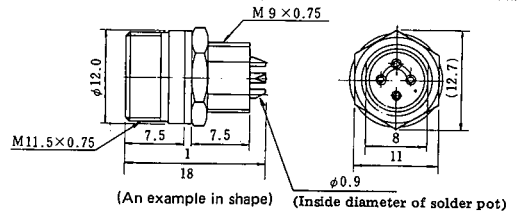
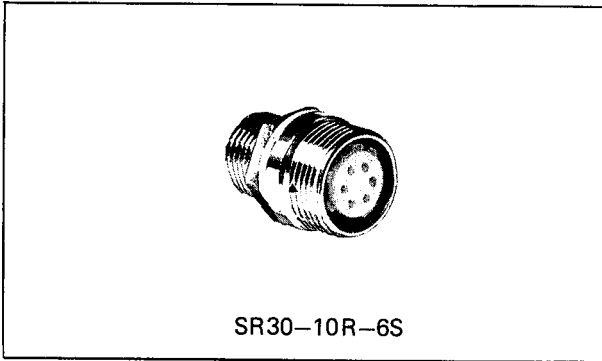

(An example in shape) (Inside diameter of solder pot)

Note 1: Some dimensions of the waterproof types different from those given below.

HRS No.	Part No.	No. of pin	Remarks
103-0264-0	SR30-10R-4S	4	
103-0239-2	SR30-10R-6S	6	
103-0317-4	SR30-10R-7S	7	Silver plated
103-0349-0	SR30-10WR-6SA	6	Waterproof

Remark: Use mounting panels 5 mm or less in thickness.

Dip Type

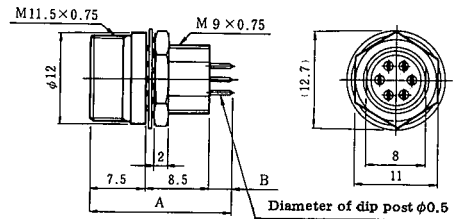
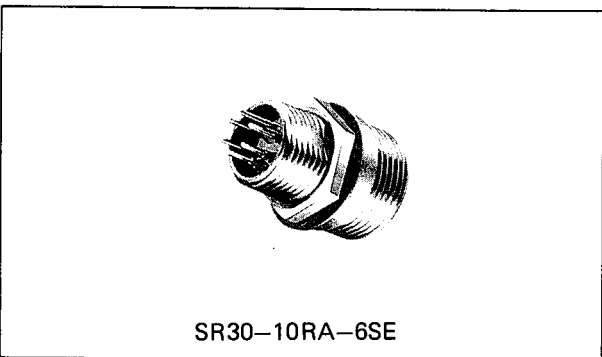

(An example in shape)

HRS No.	Part No.	No. of pin	A	B	Remarks
103-0356-6	SR30-10RA-4SE	4	19	3	Silver plated
103-0326-5-02	SR30-10RA-6SE(02)	6	19	3	
103-0327-8	SR30-10RA-7SE	7	19	3	Silver plated
103-0329-3-01	SR30-10RA-6SF(01)	6	24	8	Dip post dia. φ0.8
103-0361-6	SR30-10WR-7SE	7	19	3	Waterproof

Remark: Use mounting panels 5 mm or less in thickness.

Receptacle (Jam Nut to be fastened from front panel)

(Solder Type)

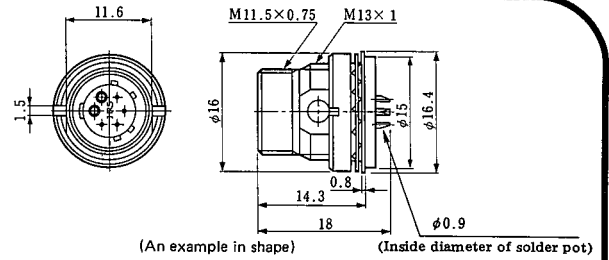
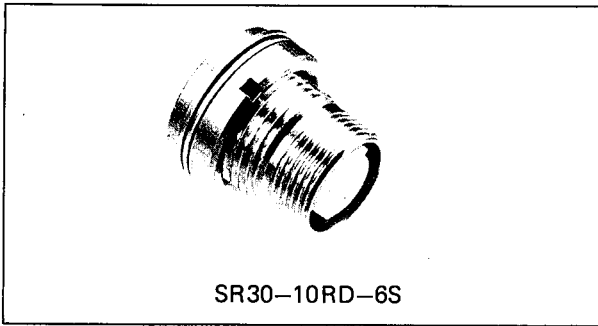

HRS No.	Part No.	No. of pins
103-0302-7	SR30-10RD-6S	6

Remark: Use mounting panel 3 mm or less in thickness.

Jack

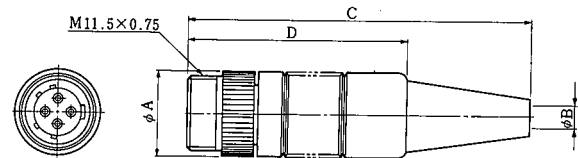
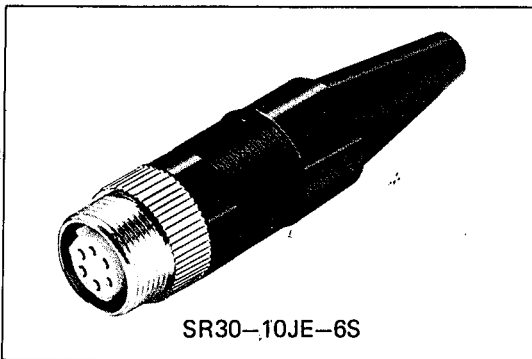

Note 1) When ordering the SR30-10JE-6S receptacles, order SR30-P cable clamps (CL103-0266-5) separately, because they have no cable clamps.

Note 2) The inside diameter of the male terminal solder pot is 0.9 mm.

HRS No.	Part No.	No. of pins	φA	φB	C	D	Remarks
103-0301-4	SR30-10JE-4S	4	13	4.3	53.5	34	
103-0259-0	SR30-10JE-6S	6	13	4.3	53.5	34	Note 1)
103-0292-5	SR30-10JM-6S	6	13	5.7	51	—	
103-0330-2	SR30-10JF-7S	7	13	5.5	57	—	Silver plated

Cap

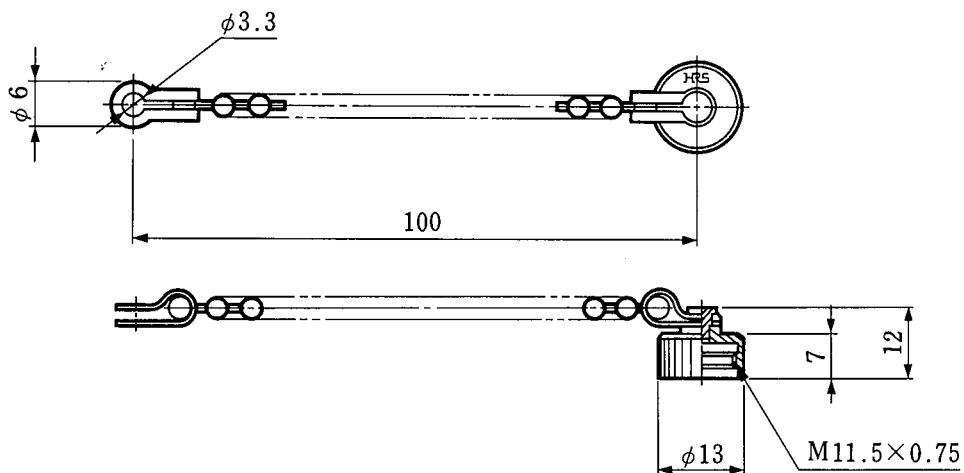

HRS No.	Part No.	Remarks
103-0344-7	SR30-10RC1	

PCB Layout

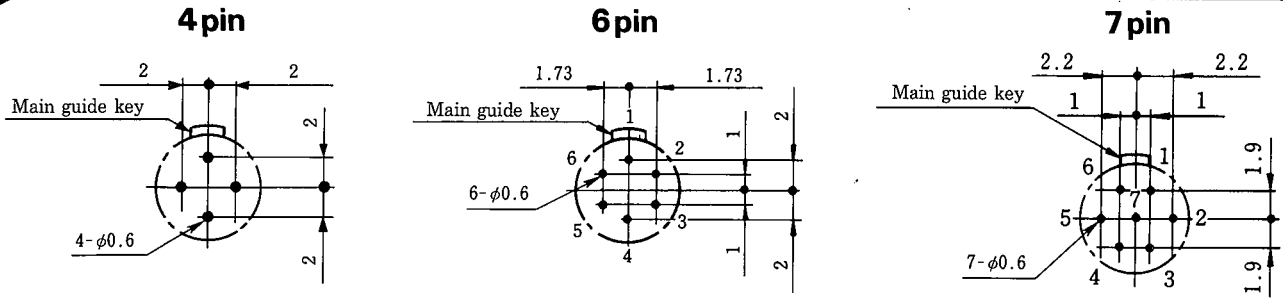

- Remarks
1. The figures show the views from the mating side.
 2. Dimensional tolerance of dip post arrangement is recommended ± 0.05 .
 3. A hole diameter of 0.9 mm is recommended for the SR30-10RA-6SF(01).

Assembling Procedure

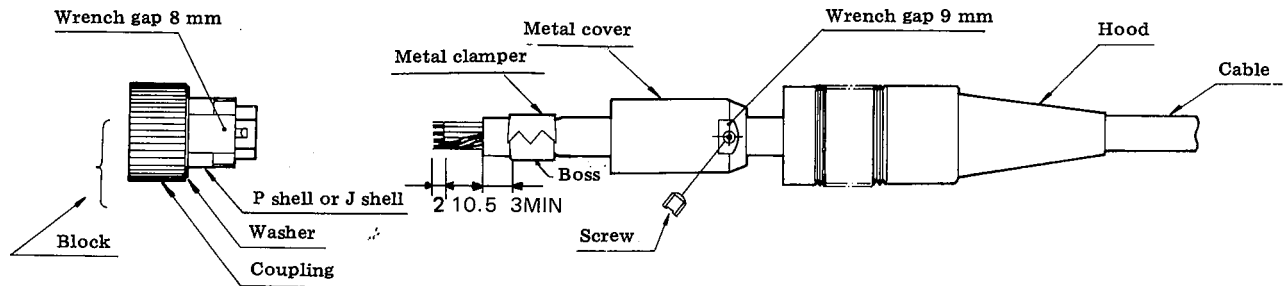

1. Use a cable of 4.2 – 4.8 m/m, for SR30-10PE-4P and SR30-10PE-6P, or 5.5 – 6.2 m/m, for SR30-10PM-6P, in the outer diameter and 0.3 m/m² in nominal conductor cross-sectional area.
2. Pass the cable through a hood and a metal cover. Cut off the end of the cable with dimensions as shown.
3. Insert an assembling tool into the block and terminate the cable by soldering.
4. Stake a metal clammer, SR30-P, to the cable several times by means of a crimping tool, SR30-10PE-T, in such a way that the outer diameter becomes about 5.2 m/m.
5. And then, fasten the metal cover into the thread section of plug shell by means of a single-acting torque wrench.
6. Thrust a screw into one of two bosses of the metal clammer in such a way that the tip of screw sinks.
7. Put a hood on the metal cover.

Tools

Clamping Tool

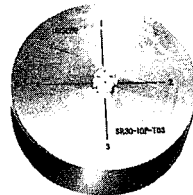

CL150-0003-3 SR30-10P-T03

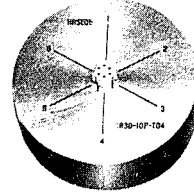

CL150-0004-6 SR30-10P-T04

Soldering and Fastening Tool

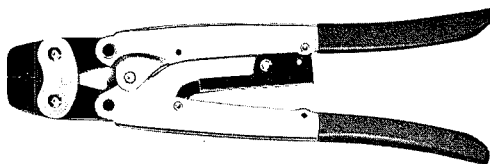

CL150-0001-8

SR30-10PE-T

Applicable Cable dia. $\phi 4.2 \sim \phi 4.8$

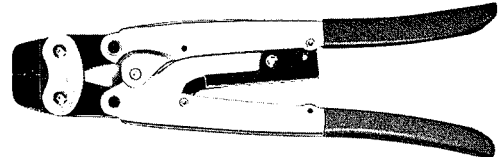

CL150-0054-4

SR30-10PM-T

Applicable Cable dia. $\phi 6$