

Features

- Low Forward Voltage
- Epitaxial Construction with Oxide Passivation
- Guard Ring for Transient and ESD Protection
- Surge Overload Rating to 125A Peak
- Low Power Loss
- Fast Switching
- Ideally Suited for Use in High Frequency SMPS, Inverters and As Free Wheeling Diodes

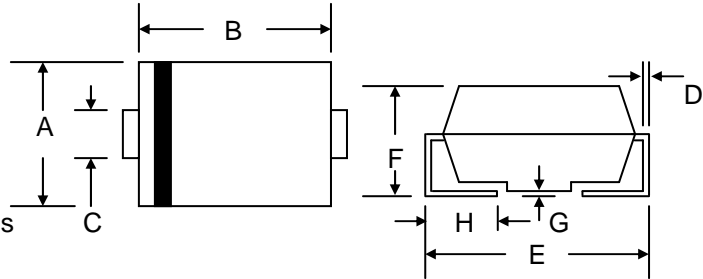

Mechanical Data

- Case: SMB/DO-214AA, Molded Plastic
- Terminals: Solder Plated, Solderable per MIL-STD-750, Method 2026
- Polarity: Cathode Band or Cathode Notch
- Marking: Device Code, See Page 3
- Weight: 0.093 grams (approx.)
- **Lead Free: For RoHS / Lead Free Version, Add "-LF" Suffix to Part Number, See Page 4**

SMB/DO-214AA		
Dim	Min	Max
A	3.30	3.94
B	4.06	4.70
C	1.91	2.11
D	0.152	0.305
E	5.08	5.59
F	2.13	2.44
G	0.051	0.203
H	0.76	1.27
All Dimensions in mm		

Maximum Ratings @ $T_A=25^\circ\text{C}$ unless otherwise specified

Characteristic	Symbol	SR5150	SR5200	Unit
Peak Repetitive Reverse Voltage Working Peak Reverse Voltage DC Blocking Voltage	V_{RRM} V_{RWM} V_R	150	200	V
RMS Reverse Voltage	$V_{R(RMS)}$	105	140	V
Average Rectified Output Current (Note 1)	I_O	5.0		A
Non-Repetitive Peak Forward Surge Current 8.3ms Single Half Sine-Wave Superimposed on Rated Load (JEDEC Method)	I_{FSM}	125		A
Forward Voltage @ $I_F = 5.0\text{A}$	V_{FM}	0.9		V
Peak Reverse Current @ $T_J = 25^\circ\text{C}$ At Rated DC Blocking Voltage @ $T_J = 100^\circ\text{C}$	I_{RM}	0.2 5.0		mA
Typical Junction Capacitance (Note 2)	C_J	120		pF
Thermal Resistance, Junction to Ambient (Note 1) Thermal Resistance, Junction to Lead (Note 1)	R_{JA} R_{JL}	70 18		$^\circ\text{C/W}$
Operating and Storage Temperature Range	T_J, T_{STG}	-55 to +150		$^\circ\text{C}$

Note: 1. Mounted on FR-4 PCB with 8.0 x 8.0mm copper pads.
2. Measured at 1.0 MHz and applied reverse voltage of 4.0V D.C.

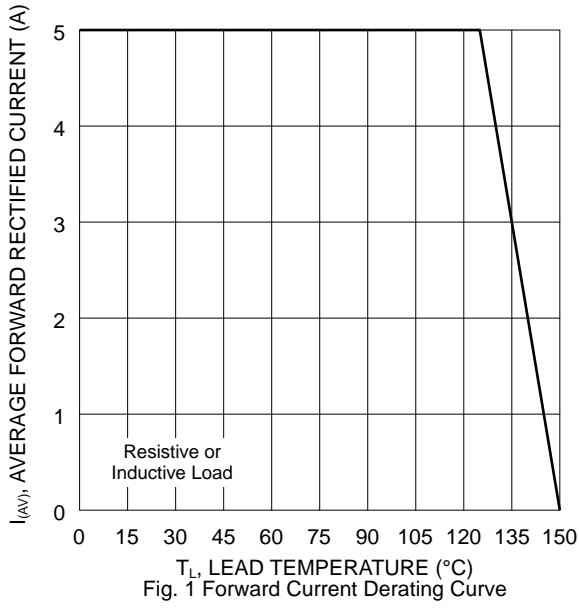

Fig. 1 Forward Current Derating Curve

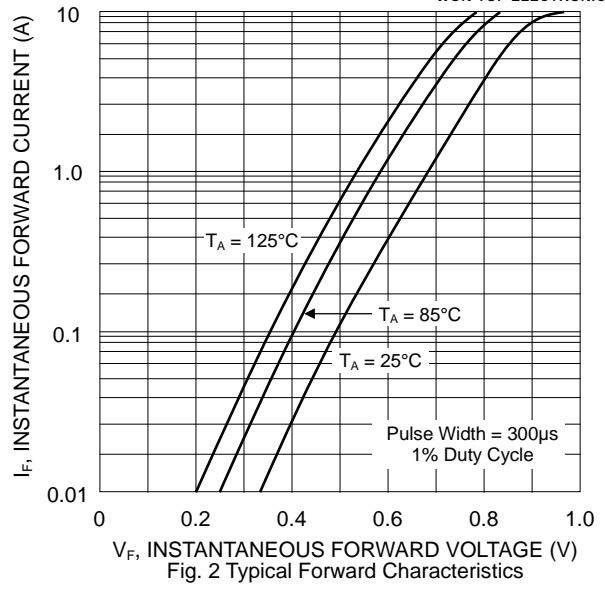

Fig. 2 Typical Forward Characteristics

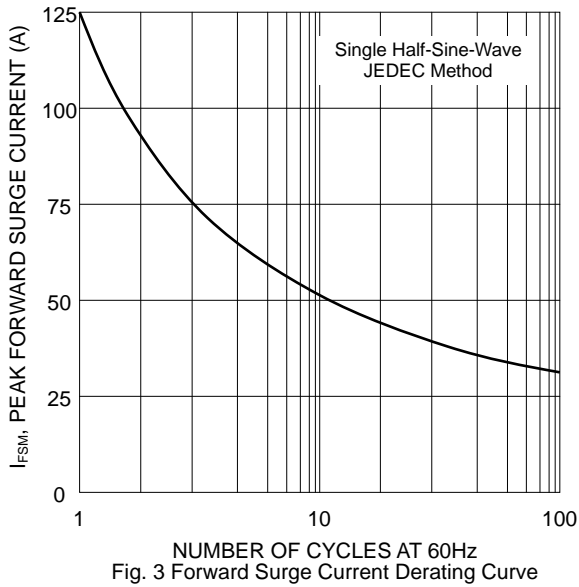

Fig. 3 Forward Surge Current Derating Curve

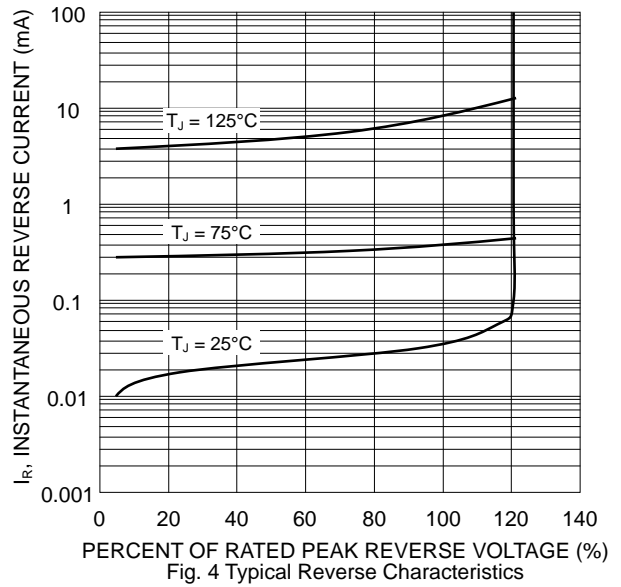

Fig. 4 Typical Reverse Characteristics

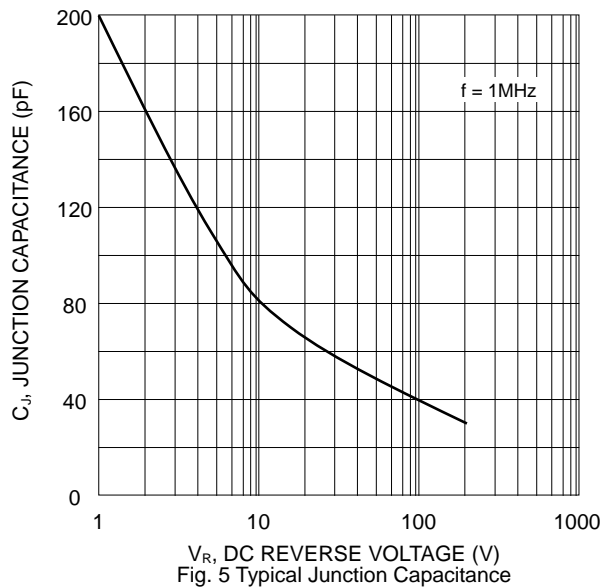
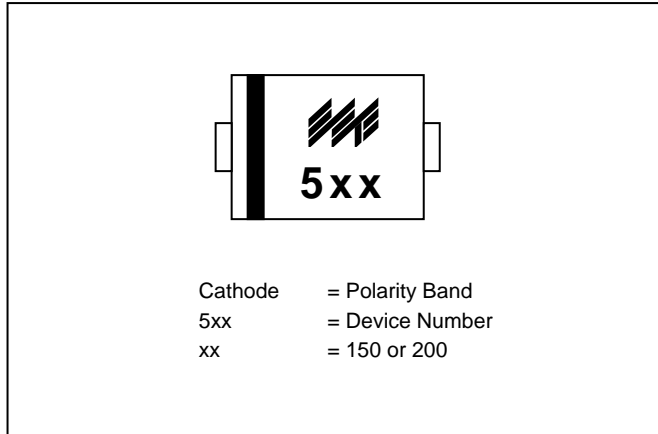
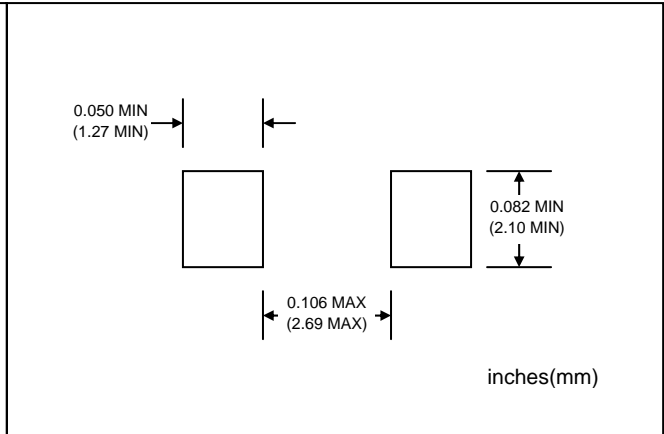

Fig. 5 Typical Junction Capacitance

MARKING INFORMATION



RECOMMENDED FOOTPRINT



PACKAGING INFORMATION

TAPE & REEL

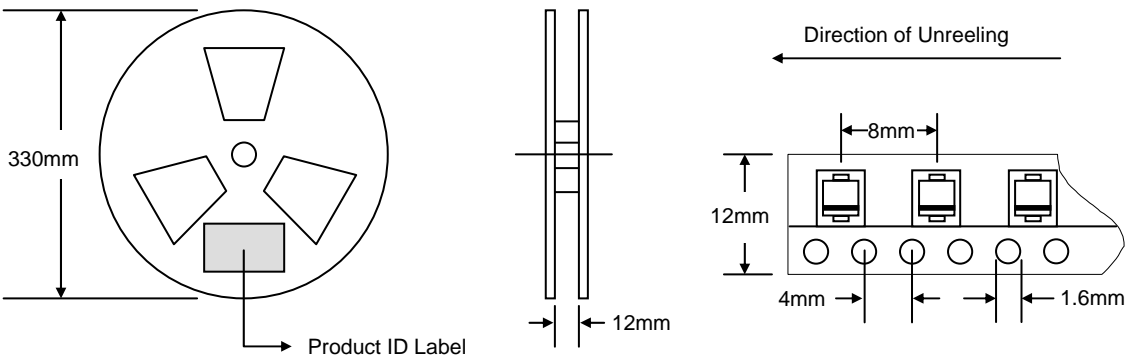

Reel Diameter (mm)	Quantity (PCS)	Inner Box Size L x W x H (mm)	Quantity (PCS)	Carton Size L x W x H (mm)	Quantity (PCS)	Approx. Gross Weight (KG)
330	3,000	340 x 337 x 45	6,000	370 x 370 x 420	48,000	14.0

Note: 1. Paper reel, white or gray color.
 2. Components are packed in accordance with EIA standard 481-1 and 481-2.

ORDERING INFORMATION

Product No.	Package Type	Shipping Quantity
SR5150-T3	SMB	3000/Tape & Reel
SR5200-T3	SMB	3000/Tape & Reel

1. Shipping quantity given is for minimum packing quantity only. For minimum order quantity, please consult the Sales Department.
2. **To order RoHS / Lead Free version (with Lead Free finish), add "-LF" suffix to part number above. For example, SR5150-T3-LF.**

WON-TOP ELECTRONICS and  are registered trademarks of Won-Top Electronics Co., Ltd (WTE). WTE has checked all information carefully and believes it to be correct and accurate. However, WTE cannot assume any responsibility for inaccuracies. Furthermore, this information does not give the purchaser of semiconductor devices any license under patent rights to manufacturer. WTE reserves the right to change any or all information herein without further notice.

WARNING: DO NOT USE IN LIFE SUPPORT EQUIPMENT. WTE power semiconductor products are not authorized for use as critical components in life support devices or systems without the express written approval.

Won-Top Electronics Co., Ltd.
No. 44 Yu Kang North 3rd Road,
Chine Chen Dist., Kaohsiung 806, Taiwan
Phone: 886-7-822-5408 or 886-7-822-5410
Fax: 886-7-822-5417
Email: sales@wontop.com
Internet: <http://www.wontop.com>

We power your everyday.