

Descriptions

- Switching application
- Interface circuit and driver circuit application

Features

- With built-in bias resistors
- Simplify circuit design
- Reduce a quantity of parts and manufacturing process
- High packing density

Ordering Information

Type NO.	Marking	Package Code
SRC1202M	1202	TO-92M

Outline Dimensions

unit : mm

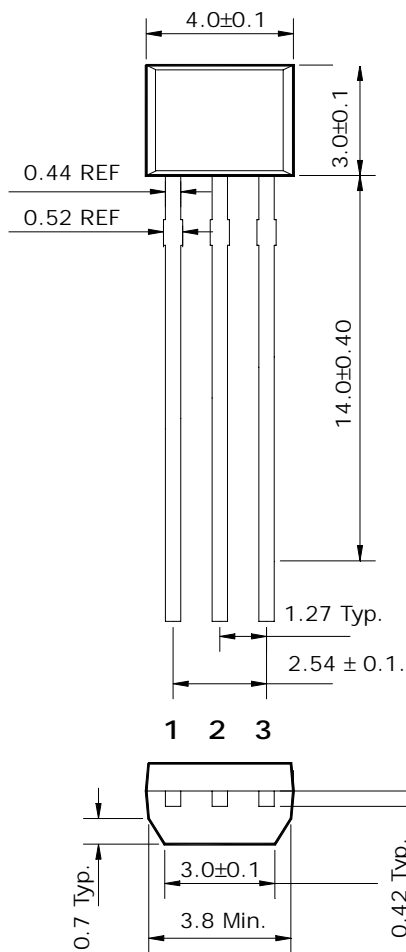

• Equivalent Circuit

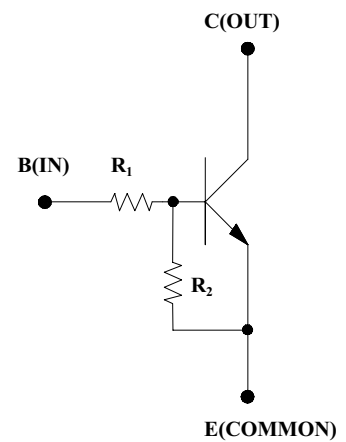

R ₁	R ₂
10KΩ	10KΩ

PIN Connections

1. Emitter
2. Collector
3. Base

Absolute maximum ratings

(Ta=25°C)

Characteristic	Symbol	Ratings	Unit
Out Voltage	V_o	50	V
Input Voltage	V_i	30	V
Out Current	I_o	100	mA
Power Dissipation	P_D	400	mW
Junction Temperature	T_J	150	°C
Storage Temperature	T_{STG}	-55 ~ 150	°C

Electrical Characteristics

(Ta=25°C)

Characteristic	Symbol	Test Condition	Min.	Typ.	Max.	Unit
Output Cut-off Current	$I_{O(OFF)}$	$V_o=50V, V_i=0$	-	-	500	nA
DC Current Gain	G_I	$V_o=5V, I_o=10mA$	50	80	-	-
Output Voltage	$V_{O(ON)}$	$I_o=10mA, I_i=0.5mA$	-	0.1	0.3	V
Input Voltage (ON)	$V_{I(ON)}$	$V_o=0.2V, I_o=5mA$	-	1.8	2.4	V
Input Voltage (OFF)	$V_{I(OFF)}$	$V_o=5V, I_o=0.1mA$	1.0	1.2	-	V
Transition Frequency	f_T^*	$V_o=10V, I_o=5mA$	-	200	-	MHz
Input Current	I_i	$V_i=5V$	-	-	0.88	mA

* : Characteristic of Transistor Only

Electrical Characteristic Curves

Fig. 1 $I_o - V_{I(ON)}$

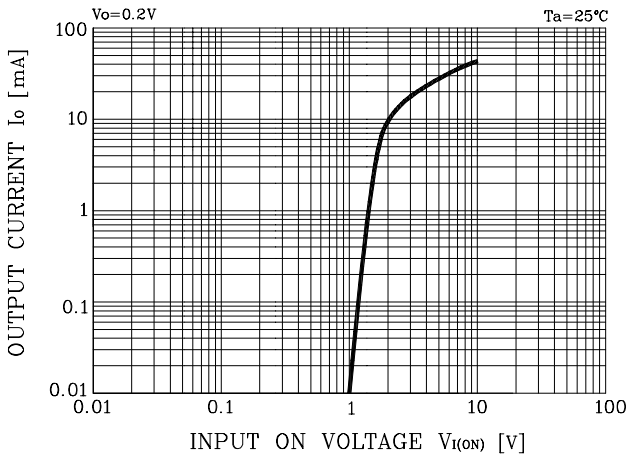

Fig. 2 $I_o - V_{I(OFF)}$

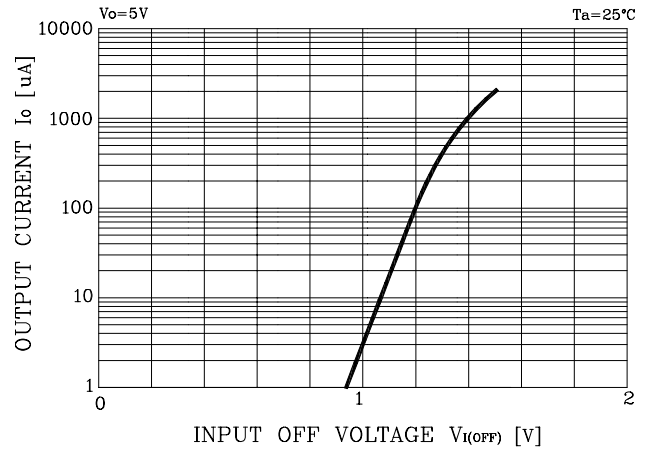

Fig. 3 $G_1 - I_o$

