

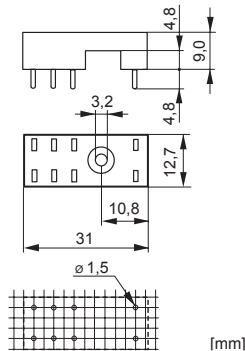

## PCB socket SRP-SGR2

- PCB socket for SGR282Z, SIR282
- With hold down clip
- Soldering tags for PCB
- 2.5mm pinning



Technical data	
Rated current	2x8A
Rated voltage	300VAC
Test voltage coil/contacts	5'000Veff
Insulation class (IEC 60664-1)	250VAC
Creepage resistance	CTI 250
Weight	approx. 4g
Ambient temperature	-40°C to +80°C
Packing unit	100 pcs
Approvals	UL, cUL

## DIN rail socket SRD-SGR2

- DIN rail socket for SGR282Z, SIR282
- With plastic grip and marking tag (1 pc)
- Screw terminals
- 5mm pinning
- Assembly on DIN rail 35mm or single-hole mounting with M3 screw

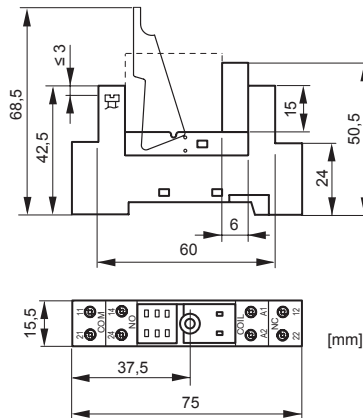
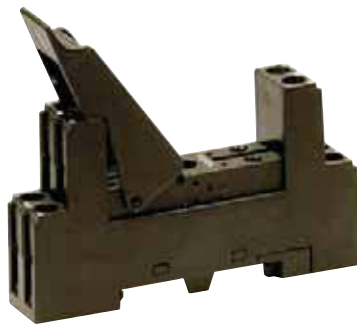

Technical data	
Rated current	2x8A
Rated voltage	300VAC
Test voltage coil/contacts	4'000Veff
Insulation class (IEC 60664-1)	250VAC
Creepage resistance	CTI 250
Weight	approx. 40g
Ambient temperature	-25°C to +80°C
Cross sections for connection with	
- wires	2x2.5mm <sup>2</sup>
- end sleeves for strands	2x1.5mm <sup>2</sup>
Torque max.	0,8 Nm
Packing unit	20 pcs
Approvals	UL, cUL

## Modules for DIN rail sockets

- Module SRD-SGR2-M01
- For DIN rail socket SRD-SGR2
  - Diode 6VDC to 230VDC (+ on terminal A1)

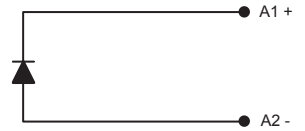

- Module SRD-SGR2-M02
- For DIN rail socket SRD-SGR2
  - Diode with red Led, 6VDC to 24VDC (+ on terminal A1)

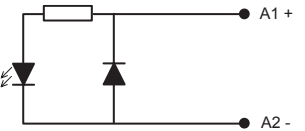

- Module SRD-SGR2-M04
- For DIN rail socket SRD-SGR2
  - Red Led, 6VDC to 24VDC (+ on terminal A1)

- Module SRD-SGR2-M05
- For DIN rail socket SRD-SGR2
  - Green Led, 6VDC to 24VDC (+ on terminal A1)





**PCB socket SRP-SIM4**

- PCB socket for SIM 4 Contacts
- With integrated retaining/ejector handles
- Soldering tags for PCB

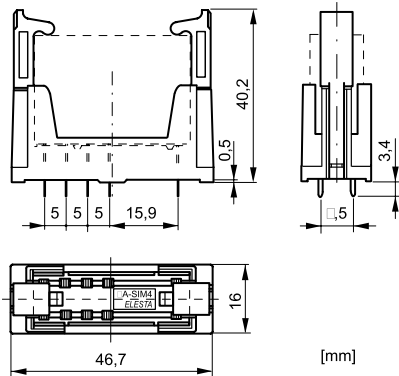

**Technical data**

Rated current	7A
Rated voltage	250VAC
Test voltage coil/contacts	4'000Veff
Insulation class (VDE 0110b)	C/250VAC
Creeping resistance	CTI 250
Ambient temperature	-25°C to +70°C
Packing unit	20 pcs
Approvals	UL, cUL

**DIN rail socket SRD-SIM4**

- DIN rail socket for SIM 4 Contacts
- With integrated retaining/ejector handles
- Screw terminals
- Assembly on DIN rail 35mm or with 2xM3 screws

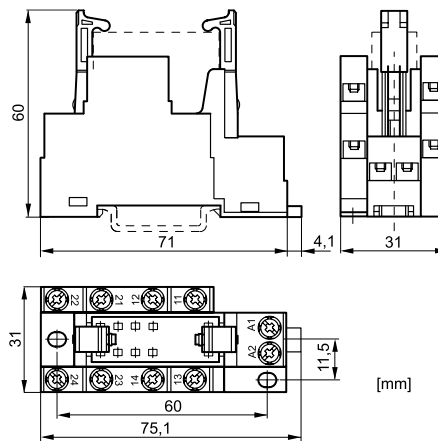

**Technical data**

Rated current	6A
Rated voltage	250VAC
Test voltage coil/contacts	2'500Veff
Insulation class (VDE 0110b)	C/250VAC
Creeping resistance	CTI 250
Ambient temperature	-25°C to +70°C
Cross sections for connection with	
- wires	2x2,5mm <sup>2</sup>
- end sleeves for strands	2x1,5mm <sup>2</sup>
Torque max.	0,8 Nm
Packing unit	10 pcs
Approvals	UL, cUL



**American Electronic Components, Inc.**

1101 Lafayette Street, Elkhart, IN 46516, Tel: (574) 295-6330, Fax: (574) 293-8013, [sales@aecensors.com](mailto:sales@aecensors.com)