

Product Description

The Sirenza Microdevices' SRM-1016 is a high linearity active mixer for use in a wide variety of communication systems covering the 800-1000 MHz frequency bands. This device operates from a single 5V supply and provides 10dB of conversion gain while requiring only 0dBm input to the integrated LO driver. The SRM-1016 also includes an integrated on chip IF amplifier and is fabricated using Silicon Germanium (SiGe) device technology.

The RF and LO ports can be driven differential or single ended. Each broadband port has been designed to minimize performance degradation while operating into highly reactive components such as SAW filters. The device is packaged in an industry standard 16 pin TSSOP with exposed paddle for superb RF and thermal ground.

Functional Block Diagram

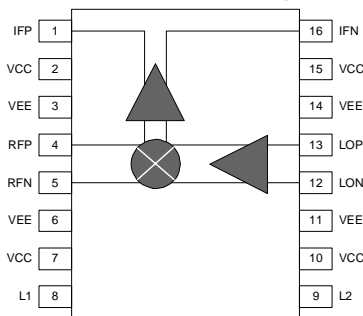

Product Specifications

Parameters	Test Conditions: $T_A = 25^\circ\text{C}$, $V_{CC} = 5.0\text{V}$ $P_{LO} = 0\text{dBm}$, $P_{RF} = -20\text{dBm}$, $IF = 200\text{MHz}$	Unit	Min.	Typ.	Max.
RF Frequency Range		MHz	800		1000
LO Frequency Range		MHz	500		1000
IF Frequency Range		MHz	30	200	300
Conversion Gain		dB	7	10	
SSB Noise Figure		dB		15	19
Input IP3	$RF1 = RF2 = -15\text{ dBm/tone}$, 1 MHz spacing	dBm	+15	+19	
Input P1dB		dBm	+2	+5	
Leakage (LO-RF)	Single-ended configuration, see Note 1, page 3	dBm		-40	-35
Leakage (LO-IF)	Single-ended configuration, see Note 1, page 3	dBm		-26	-20
Leakage (RF-IF)	Single-ended configuration, see Note 1, page 3	dBm		-40	-35
RF, LO, IF Return Loss	Matched to 50Ω , see Note 2, page 3	dB		20	
Supply Voltage (Vcc)		V	+4.75	+5.0	+5.25
Supply Current		mA		160	180
LO Drive	Matched to 50Ω , see Note 2, page 3	dBm	-3	0	+3
Thermal Resistance	junction-case	$^\circ\text{C/W}$		46	

The information provided herein is believed to be reliable at press time. Sirenza Microdevices assumes no responsibility for inaccuracies or omissions.

Sirenza Microdevices assumes no responsibility for the use of this information, and all such information shall be entirely at the user's own risk. Prices and specifications are subject to change without notice. No patent rights or licenses to any of the circuits described herein are implied or granted to any third party. Sirenza Microdevices does not authorize or warrant any Sirenza Microdevices product for use in life-support devices and/or systems.

Copyright 2002 Sirenza Microdevices, Inc. All worldwide rights reserved.

522 Almanor Ave., Sunnyvale, CA 94085

Phone: (800) SMI-MMIC

1

<http://www.sirenza.com>

EDS-102145 Rev B

SRM-1016

800 - 1000 MHz High Linearity Active Receive Mixer

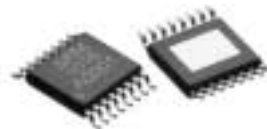

16 pin TSSOP with Exposed Ground Pad

Package Footprint: 0.197 x 0.252 inches (5.0 x 6.4 mm)

Package Height: 0.039 inches (1.0 mm)

Product Features

- Active mixer with 10dB conversion gain
- Integrated 0dBm LO drive and IF amplifier
- Differential or single-ended input
- Single supply operation (+5V)
- Broadband resistive 50Ω impedances on all three ports

Applications

- 800-1000 MHz receivers

Typical Device Performance

Conversion Gain vs Temperature

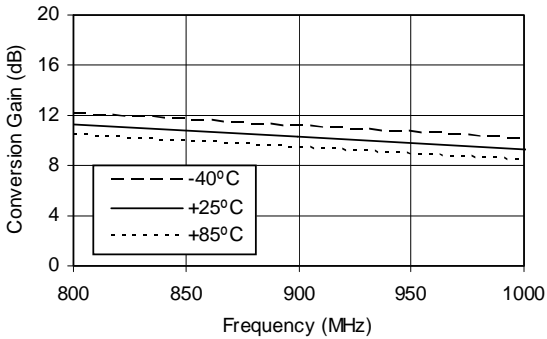

Input IP3 vs Temperature

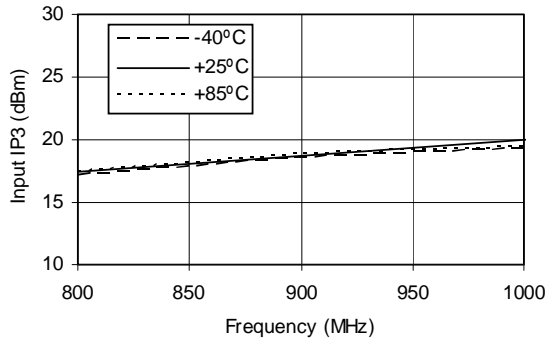

**Conversion Gain vs LO Drive
T=+25°C**

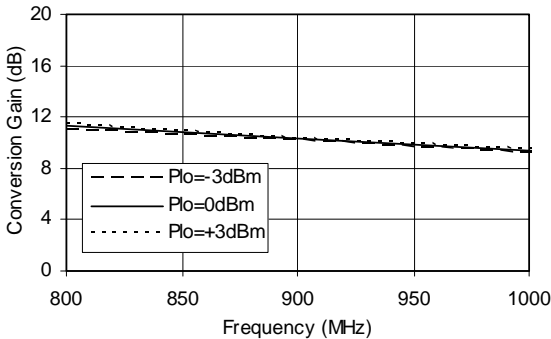

**Input IP3 vs LO Drive
T=+25°C**

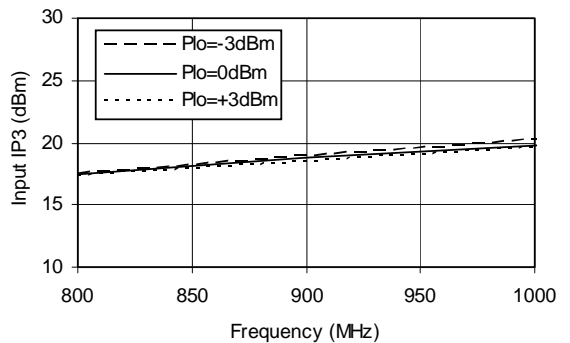

Leakages

Plo=0 dBm, Prf=-20 dBm

Single-Ended Configuration (Note 1)

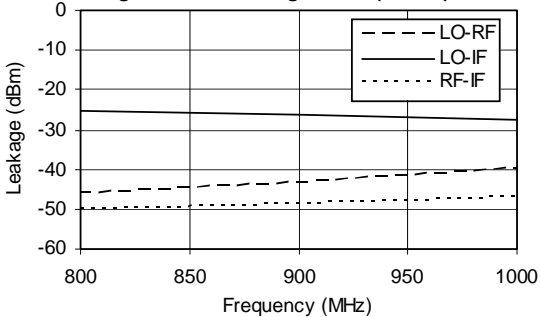

**Noise Figure vs Temperature
Plo=0dBm**

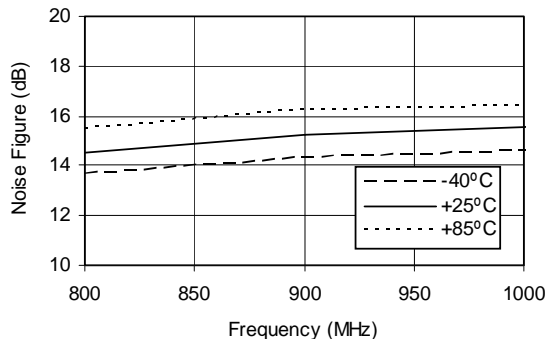

Typical Device Performance

RF & LO Return Loss (Note 2)
T=+25°C

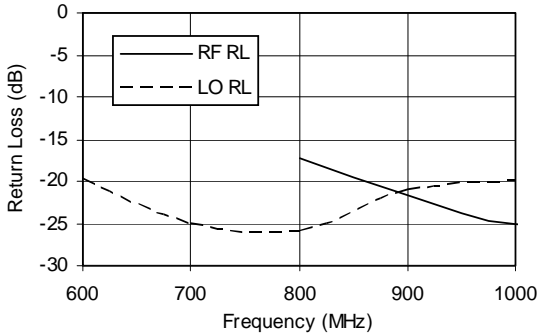

Input P1dB vs Temperature
Plo=0dBm

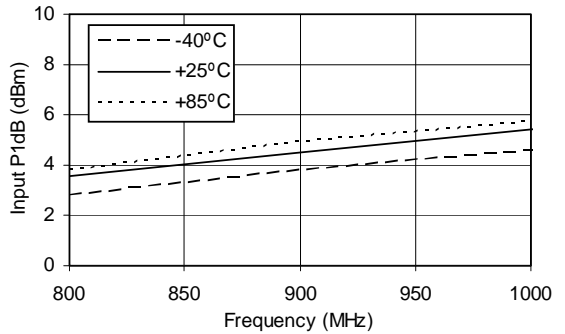

IF Return Loss (Note 2)
T=+25°C

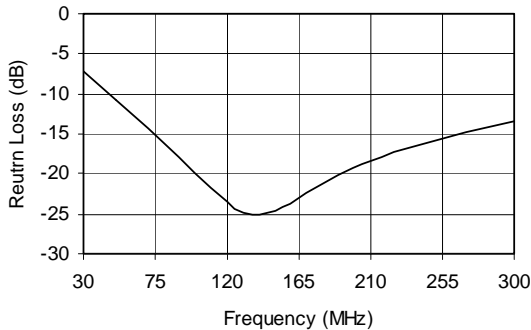

Input P1dB vs LO Drive
T=+25°C

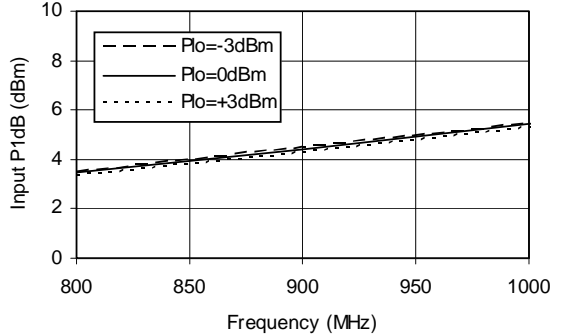

Note 1:

Leakage performance shown (LO-RF, LO-IF, RF-IF) is for a single-ended RF, LO, IF configuration. Differential drive will improve leakage performance. Contact applications engineering for differential vs. single-ended drive trade-offs.

Note 2:

The return losses shown were measured with the SRM-1016 mounted on our FR4 evaluation boards using standard matching practices as indicated on the application schematic page (5) herein. Users following the RF, LO and IF matching guidelines will achieve similar performance.

SRM-1016 SiGe Active Receive Mixer

Package Dimensions ("16" Package)

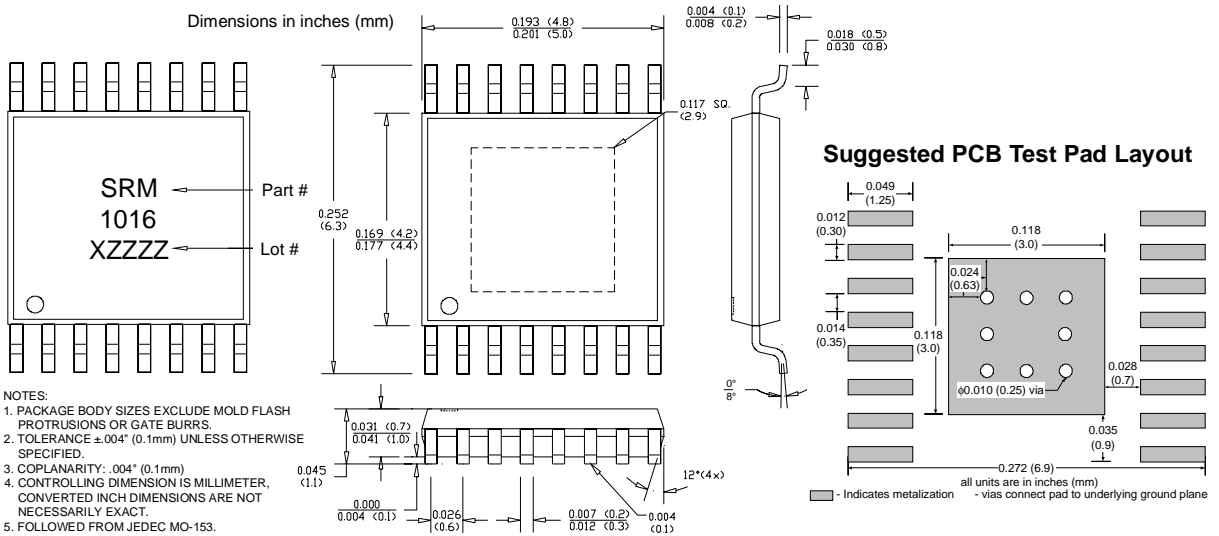

Pin Out Description

Pin #	Function	Description	Additional Comments
1	IFP	IF output, positive terminal	Nominal DC voltage is 1.6V. Output should be AC-coupled
2	VCC	Positive supply (+5V)	
3	VEE	Ground	
4	RFP	RF input, positive terminal	Nominal DC voltage is 2.1V. (Internally biased) Input should be AC-coupled.
5	RFN	RF input, negative terminal	Nominal DC voltage is 2.1V. (Internally biased) Input should be AC-coupled.
6	VEE	Ground	
7	VCC	Positive supply (+5V)	
8	L1	External inductor terminal	Nominal DC voltage is 5V, provided through off chip inductors.
9	L2	External inductor terminal	Nominal DC voltage is 5V, provided through off chip inductors.
10	VCC	Positive supply (+5V)	
11	VEE	Ground	
12	LON	LO input, negative terminal	Nominal DC voltage is 2.4V. (Internally biased) Input should be AC-coupled.
13	LOP	LO input, positive terminal	Nominal DC voltage is 2.4V. (Internally biased) Input should be AC-coupled.
14	VEE	Ground	
15	VCC	Positive supply (+5V)	
16	IFN	IF output, negative terminal	Nominal DC voltage is 1.6V. Output should be AC-coupled.

Absolute Maximum Ratings

Parameters	Value	Unit
Supply Voltage (Vcc)	+6.0	V _{DC}
LO Input (LOP, LON)	+10	dBm
RF Input (RFP, RFN)	+15	dBm
Operating Temperature	-40 to +85	°C
Storage Temperature	-65 to +150	°C

Operation of this device beyond any one of these limits may cause permanent damage. For reliable continuous operation the device voltage and current must not exceed the maximum operating values specified in the table on page one.

Part Number Ordering Information

Part Number	Reel Size	Devices/Reel
SRM-1016	7"	1000



Caution: ESD Sensitive

Appropriate precaution in handling, packaging and testing devices must be observed.

Demo Test Board Schematic

SRM-1016 SiGe Active Receive Mixer

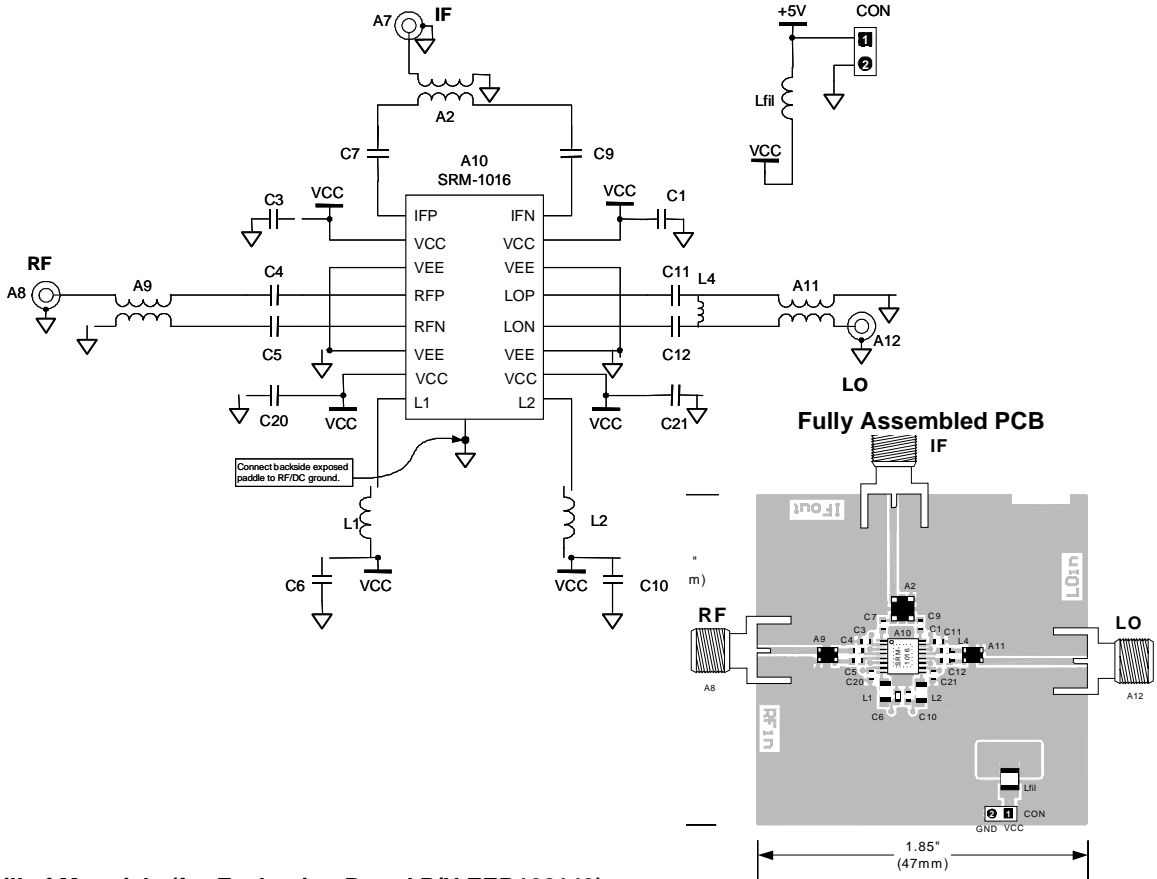

Bill of Materials (for Evaluation Board P/N EEB102149)

Component Designator	Value	Qty	Vendor	Part Number	Description
A10		1	SMDI	SRM-1016	SiGe Receive Mixer
A9, A11	1:1	2	Panasonic	EHF-FD1618	RF transformer
A7, A8, A12		3	Johnson Components	142-0701-851	SMA connector, end launch with tab, for 62 mil thick board
CON		1	Digikey	S1212-36-ND	2-pin header
A2	1:1	1	Mini-Circuits	TC1-1	IF transformer
Lfil	1uH	1	Digikey	PCD1008CT-ND	Inductor, 1210 footprint, min. 200mA rating
C1, C3, C20, C21	27pF	4	Venkel	C0603COG500-270JNE	Capacitor, 0603 footprint
C6, C10	100pF	2	Venkel	C0603COG500-101JNE	Capacitor, 0603 footprint
C7, C9	120pF	2	Venkel	C0603COG500-121JNE	Capacitor, 0603 footprint
C4, C5	10pF	2	Venkel	C0805COG500-100JNE	Capacitor, 0603 footprint
C11, C12	6.8pF	2	Venkel	C0805COG500-6R8JNE	Capacitor, 0603 footprint
L1, L2	see Page 6	2	TOKO		Inductor, 0603 footprint, high Q series
L4	18nH	2	TOKO	LL1608-FS18NJ	Inductor, 0603 footprint, high Q series

SiGe Receive Mixer: General Test Set-Up

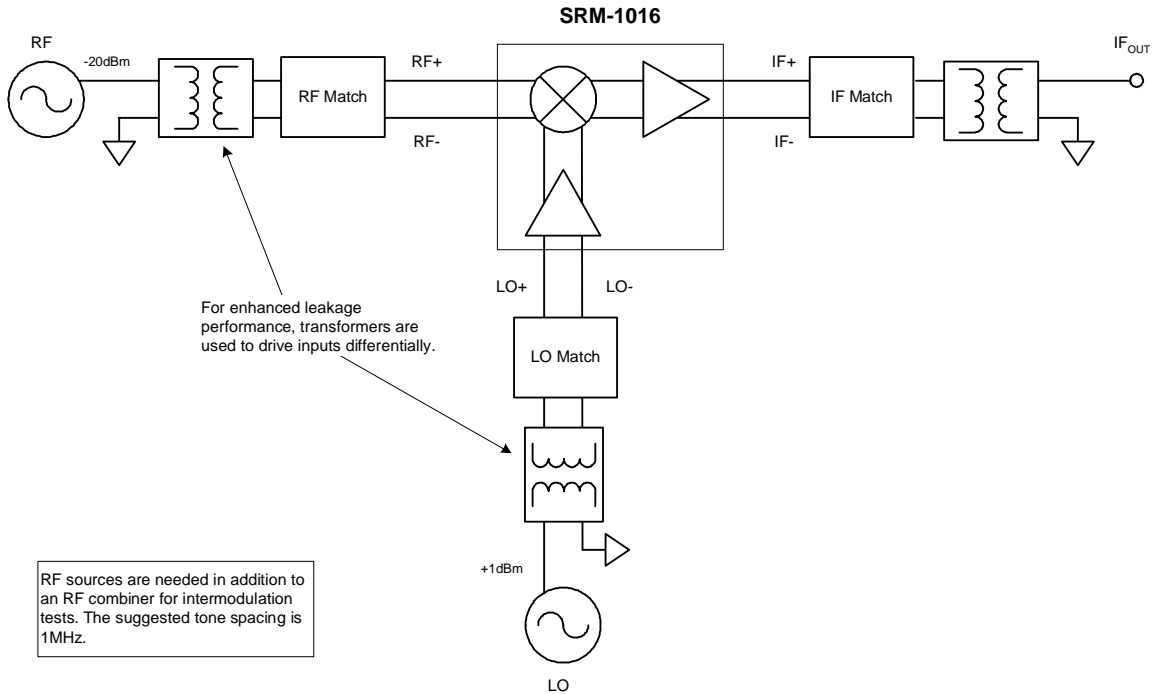

The SRM-1016 utilizes an IF tank circuit to maximize performance across the entire IF bandwidth. The off-chip inductors L1 and L2 resonate with on-chip capacitors (4pF) to provide IF tunability. Therefore, L1 and L2 must be selected such that the resonance occurs at the desired IF. The table below provides the inductor values required on

the evaluation board for some common intermediate frequencies. By default, all evaluation boards are shipped with L1 = L2 = 100nH, resulting in a 200 MHz resonant IF. Also note, L1 and L2 should be placed within 1mm (0.039 in) of pins 9 and 10 for optimal performance.

IF (MHz) "typical"	L1, L2 (nH)	TOKO Part Number
70	680	LL2012-FHR68J
150	150	LL1608-FSR15J
200	100	LL1608-FSR10J
300	39	LL1608-FS39NJ

The following procedure may be used to ensure that the proper inductor values have been selected for a given IF:

1. Using the "General Test Set-Up" prepare the evaluation board for a conversion gain measurement.
2. Enable the "Max Hold" function on the spectrum analyzer and set the "SPAN" to 200 MHz.
3. Vary the LO frequency while maintaining a constant input frequency.
4. The resonance will be observed at the peak of the response.