

Features and Benefits

- Wide operating voltage range from 3.5V to 24V
- Medium sensitivity
- CMOS technology
- Chopper-stabilized amplifier stage
 - Superior temperature stability
 - Extremely low switchpoint drift
 - Insensitive to physical stress
- Low current consumption
- Open drain output
- Tiny SOT23 3L or flat SIP 3L both RoHS Compliant packages

Application Examples

- Automotive, Consumer and Industrial
- Solid-state switch
- Interrupter
- Speed detection
- Linear position detection
- Angular position detection
- Proximity detection

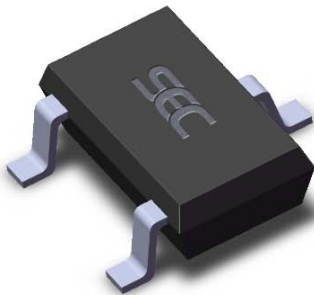

3 pin SOT23 (suffix SO)



3 pin SIP (suffix UA)

Functional Block Diagram

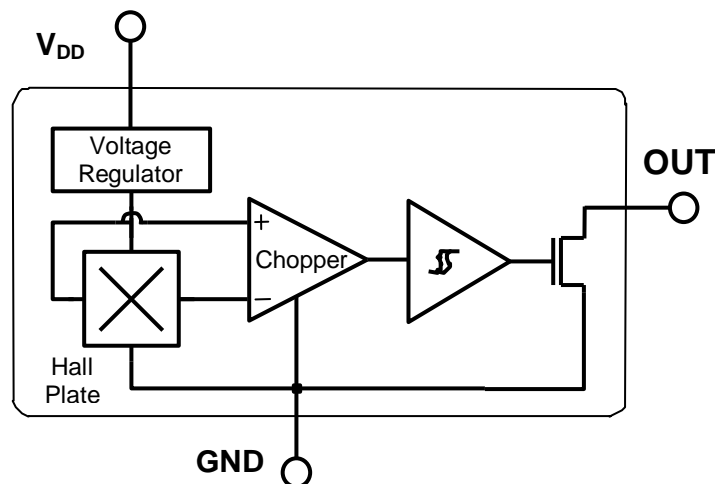

SIP Package	SOT Package
Pin 1 - V _{DD}	Pin 1 - V _{DD}
Pin 2 - GND	Pin 2 - OUT
Pin 3 - OUT	Pin 3 - GND

General Description

The SS1352 is a unipolar Hall effect sensor IC fabricated from mixed signal CMOS technology. The device integrates a voltage regulator, Hall sensor with dynamic offset cancellation system, Schmitt trigger and an open-drain output driver, all in a single package.

It incorporates advanced chopper stabilization techniques to provide accurate and stable magnetic switch points. There are many applications for this

HED – Hall Electronic Device - in addition to those listed above. Thanks to its wide operating voltage range and extended choice of temperature range, it is quite suitable for use in automotive, industrial and consumer applications.

The device is delivered in a Small Outline Transistor (SOT) for surface mount process or in a Plastic Single In Line (SIP flat) for through-hole mount. Both 3-lead packages are RoHS compliant.

Glossary of Terms

MilliTesla (mT), Gauss	Units of magnetic flux density: 1mT = 10 Gauss
RoHS	Restriction of Hazardous Substances
Operating Point (B_{OP})	Magnetic flux density applied on the branded side of the package which turns the output driver ON ($V_{OUT} = V_{DSon}$)
Release Point (BRP)	Magnetic flux density applied on the branded side of the package which turns the output driver OFF ($V_{OUT} = high$)

Pins Definition and Description

SOT Pin №	SIP Pin №	Name	Type	Function
1	1	V _{DD}	Supply	Supply Voltage pin
2	3	OUT	Output	Open Drain Output pin
3	2	GND	Ground	Ground pin

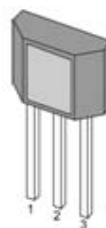
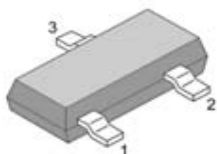

Unique Features

Based on mixed signal CMOS technology, SS1352 is a Hall-effect device with high magnetic sensitivity. This multi-purpose latch meets most of the application requirements.

The chopper-stabilized amplifier uses switched capacitor technique to suppress the offset generally observed with Hall sensors and amplifiers. The CMOS technology makes this advanced technique possible and contributes to smaller chip size and lower current consumption than bipolar technology. The small chip size is also an important factor to minimize the effect of physical stress. This combination results in more stable magnetic characteristics and enables faster and more precise design.

The wide operating voltage from 2.5V to 24V, low current consumption and large choice of operating temperature range according to “L”, “K” and “E” specifications make this device suitable for automotive, industrial and consumer applications.

Absolute Maximum Ratings

Parameter	Symbol	Value	Units
Supply Voltage	V _{DD}	28	V
Supply Current	I _{DD}	50	mA
Output Voltage	V _{OUT}	28	V
Output Current	I _{OUT}	50	mA
Storage Temperature Range	T _S	-50 to 150	°C
Maximum Junction Temperature	T _J	165	°C

Operating Temperature Range	Symbol	Value	Units
Temperature Suffix “E”	T_A	-40 to 85	°C
Temperature Suffix “K”	T_A	-40 to 125	°C
Temperature Suffix “L”	T_A	-40 to 150	°C

Exceeding the absolute maximum ratings may cause permanent damage. Exposure to absolute-maximum- rated conditions for extended periods may affect device reliability.

General Electrical Specifications

DC Operating Parameters $T_A = 25^\circ\text{C}$, $V_{DD}=3.5\text{V}$ to 24V (unless otherwise specified)

Parameter	Symbol	Test Conditions	Min	Typ	Max	Units
Supply Voltage	V_{DD}	Operating	3.5		24	V
Supply Current	I_{DD}	$B < B_{RP}$			5	mA
Output Saturation Voltage	V_{DSon}	$I_{OUT} = 20\text{mA}$, $B > B_{OP}$			0.5	V
Output Leakage Current	I_{OFF}	$B < B_{RP}$ $V_{OUT} = 24\text{V}$		1	10	μA
Output Rise Time	t_r	$R_L = 1\text{k}\Omega$, $C_L = 20\text{pF}$		0.25		μs
Output Fall Time	t_f	$R_L = 1\text{k}\Omega$, $C_L = 20\text{pF}$		0.25		μs
Maximum Switching Frequency	F_{SW}	---		10		KHz
Package Thermal Resistance	R_{TH}	Single layer (1S) Jeduc board		301		°C/W

Note: The output of SS1352 will be switched after the supply voltage is over 2.2V, but the magnetic characteristics won't be normal until the supply is over 3.5V.

Magnetic Specifications

DC Operating Parameters $V_{DD} = 3.5$ to 24V (unless otherwise specified)

Package	Parameter	Symbol	Test Conditions	Min	Typ	Max	Units
UA	Operating Point	B_{OP}	$T_a=25^\circ\text{C}, V_{dd}=12\text{V DC}$	-160		-100	G
	Release Point	B_{RP}		-140		-50	G
	Hysteresis	B_{HYST}			40		G
SO	Operating Point	B_{OP}	$T_a=25^\circ\text{C}, V_{dd}=12\text{V DC}$	100		160	G
	Release Point	B_{RP}		50		140	G
	Hysteresis	B_{HYST}			40		G

Output Behavior versus Magnetic Pole

DC Operating Parameters $T_A = -40^{\circ}\text{C}$ to 150°C , $V_{DD} = 3.5$ to 24V (unless otherwise specified)

Test Conditions (UA)	Test Conditions (SO)	OUT
$B > B_{RP}$	$B < B_{RP}$	High
$B < B_{OP}$	$B > B_{OP}$	Low

The SOT-23 device is reversed from the UA package. The SOT-23 output transistor will be turned on (drops low) in the presence of a sufficiently strong South pole magnetic field applied to the marked face.



Application Information

It is strongly recommended that an external bypass capacitor be connected (in close proximity to the Hall sensor) between the supply (V_{DD} Pin) and ground (GND Pin) of the device to reduce both external noise and noise generated by the chopper stabilization technique. As is shown in the following figure, a $0.1\mu\text{F}$ capacitor is typical.

For reverse voltage protection, it is recommended to connect a resistor or a diode in series with the V_{DD} pin. When using a resistor, three points are important:

- the resistor has to limit the reverse current to 50mA maximum ($V_{CC} / R1 \leq 50\text{mA}$)
- the resulting device supply voltage V_{DD} has to be higher than V_{DD} min ($V_{DD} = V_{CC} - R1 * I_{DD}$)
- the resistor has to withstand the power dissipated in reverse voltage condition ($P_D = V_{CC}^2 / R1$)

When using a diode, a reverse current cannot flow and the voltage drop is almost constant ($\approx 0.7\text{V}$).

Therefore, a $100\Omega/0.25\text{W}$ resistor for 5V application and a diode for higher supply voltage are recommended.

Typical Three-Wire Application Circuit

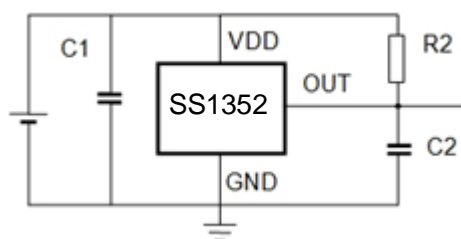

When a weak power supply is used or when the device is intended to be used in noisy environment, it is

recommended that following figure is used.

Automotive and Severe Environment Protection Circuit

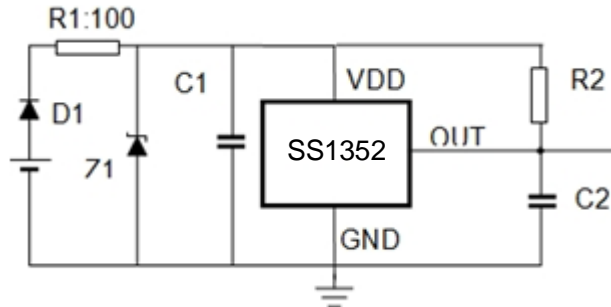

The low-pass filter formed by $R1$ and $C1$ and the Zener diode $Z1$ bypass the disturbances or voltage spikes occurring on the device supply voltage V_{DD} . The diode $D1$ provides additional reverse voltage protection. Both solutions provide the required reverse voltage protection.

ESD Precautions

Electronic semiconductor products are sensitive to Electro Static Discharge (ESD).

Always observe Electro Static Discharge control procedures whenever handling semiconductor products.

Package Information

Package SO, 3-Pin (SOT-23):

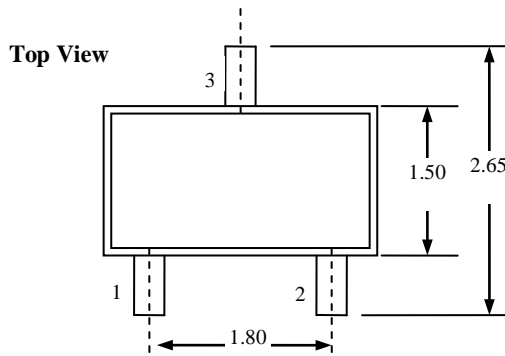

Notes:

- 1). PINOUT: Pin 1 V_{DD}
Pin 2 Output
Pin 3 GND
- 2). All dimensions are in millimeters;

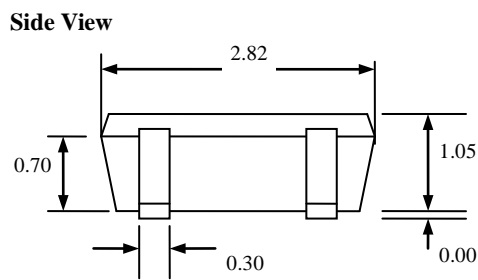

End View

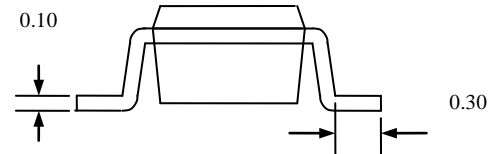

Bottom View of SOT-23 Package

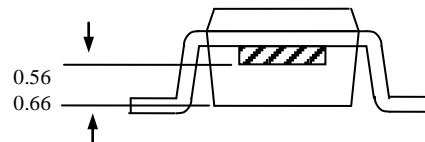
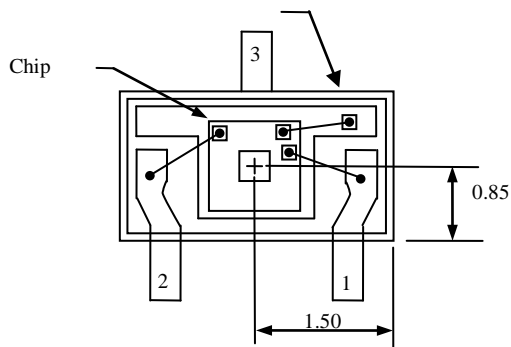

Package UA, 3-Pin SIP(TO-92):

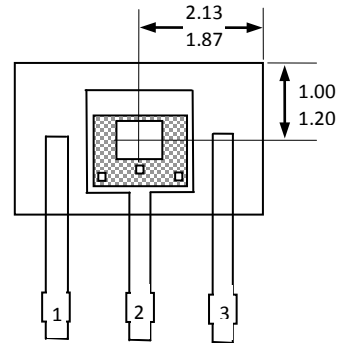
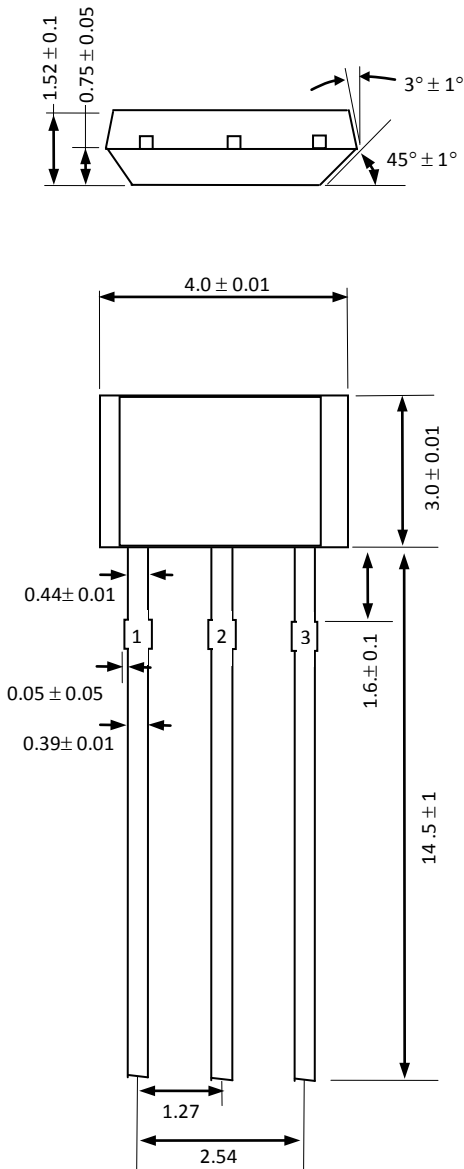

Sensor Location

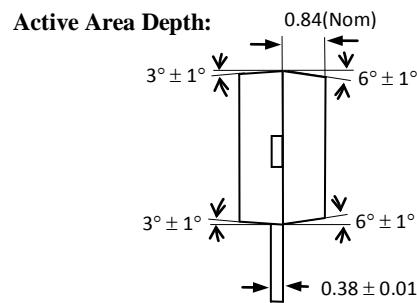

Notes:

- 1). Controlling dimension : mm ;
- 2). Leads must be free of flash and plating voids ;
- 3). Do not bend leads within 1 mm of lead to package interface ;
- 4). PINOUT: Pin 1 V_{DD}
Pin 2 GND
Pin 3 Output

Ordering Information

Part No.	Pb-free	Temperature Code	Package Code	Packing
SS1352EUA	YES	-40°C to 85°C	SOT-23	Bulk, 1000 pieces/bag
SS1352ESOT	YES	-40°C to 85°C	SOT-23	7-in. reel, 3000 pieces/reel
SS1352KUA	YES	-40°C to 125°C	SOT-23	Bulk, 1000 pieces/bag
SS1352KSOT	YES	-40°C to 125°C	SOT-23	7-in. reel, 3000 pieces/reel
SS1352LUA	YES	-40°C to 150°C	SOT-23	Bulk, 1000 pieces/bag
SS1352LSOT	YES	-40°C to 150°C	SOT-23	7-in. reel, 3000 pieces/reel