

Surface Mount Schottky Barrier Rectifier

Reverse Voltage - 20 to 200 V Forward Current - 3.0A

FEATURES

- Metal silicon junction, majority carrier conduction
- For surface mounted applications
- Low power loss, high efficiency
- High forward surge current capability
- For use in low voltage, high frequency inverters, free wheeling, and polarity protection applications

MECHANICAL DATA

- Case: SMAF
- Terminals: Solderable per MIL-STD-750, Method 2026
- Approx. Weight: 27mg 0.00086oz

PINNING

PIN	DESCRIPTION
1	Cathode
2	Anode

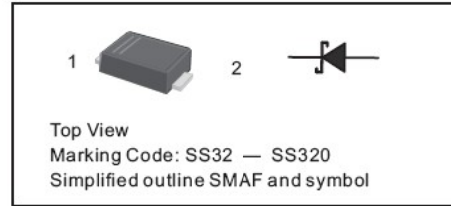

Absolute Maximum Ratings and Electrical characteristics

Ratings at 25 °C ambient temperature unless otherwise specified. Single phase, half wave, 60Hz resistive or inductive load, for capacitive load, derate by 20 %

Parameter	Symbols	SS32F	SS34F	SS36F	SS38F	SS310F	SS312F	SS315F	SS320F	Units
Maximum Repetitive Peak Reverse Voltage	V_{RRM}	20	40	60	80	100	120	150	200	V
Maximum RMS voltage	V_{RMS}	14	28	42	56	70	84	105	140	V
Maximum DC Blocking Voltage	V_{DC}	20	40	60	80	100	120	150	200	V
Maximum Average Forward Rectified Current	$I_{F(AV)}$	3.0								A
Peak Forward Surge Current, 8.3ms Single Half Sine-wave Superimposed on Rated Load (JEDEC method)	I_{FSM}	80				70				A
Max Instantaneous Forward Voltage at 3 A	V_F	0.55		0.70		0.85		0.95		V
Maximum DC Reverse Current $T_a = 25^\circ\text{C}$ at Rated DC Reverse Voltage $T_a = 100^\circ\text{C}$	I_R	0.5 10		0.3 5						mA
Typical Junction Capacitance ¹⁾	C_j	250				160				pF
Typical Thermal Resistance ²⁾	$R_{\theta JA}$	40								°C/W
Operating Junction Temperature Range	T_j	-55 ~ +125								°C
Storage Temperature Range	T_{stg}	-55 ~ +150								°C

1) Measured at 1MHz and applied reverse voltage of 4 V D.C. 2) P.C.B. mounted with 0.2 X 0.2" (5 X 5 mm) copper pad areas.

SK MAKE CONSCIOUS PRODUCT

CONSCIOUS PRODUCTS BEGIN WITH CONSCIOUS PEOPLE

Rev:06



www.shike.tw

Fig.1 Forward Current Derating Curve

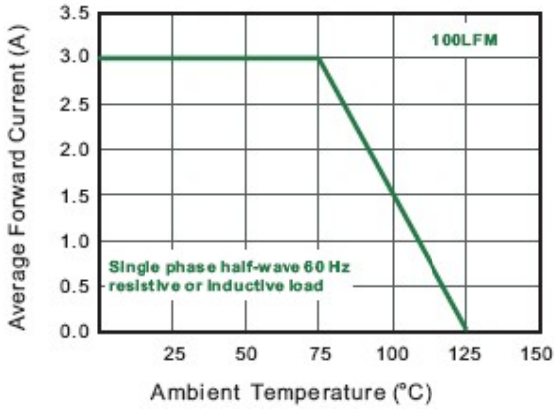

Fig.2 Typical Reverse Characteristics

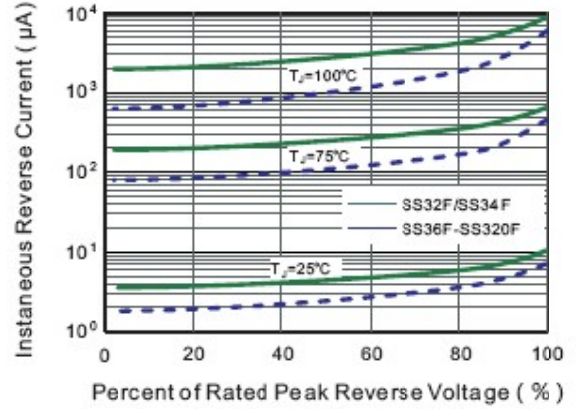

Fig.3 Typical Forward Characteristic

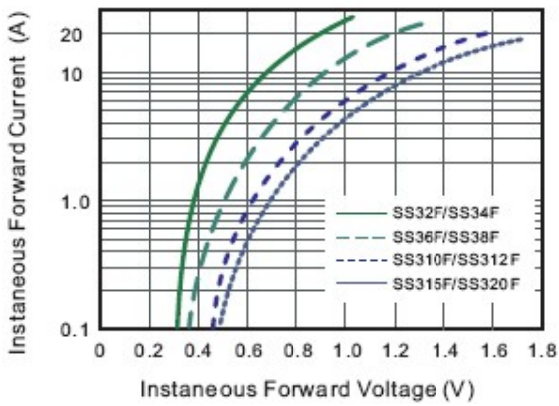

Fig.4 Typical Junction Capacitance

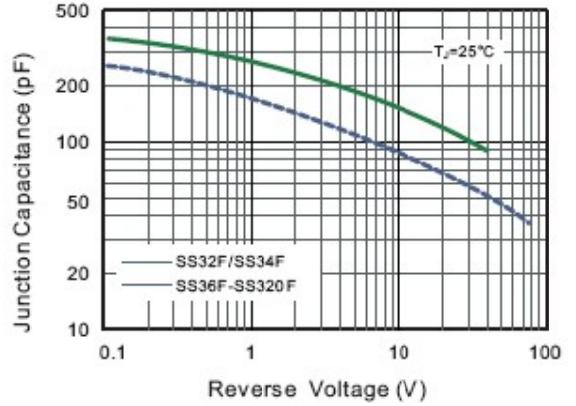

Fig.5 Maximum Non-Repetitive Peak Forward Surge Current

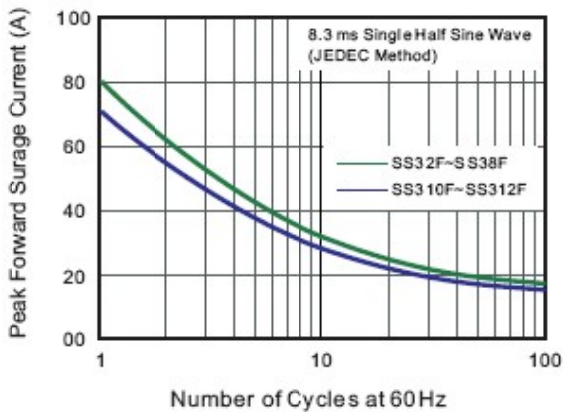
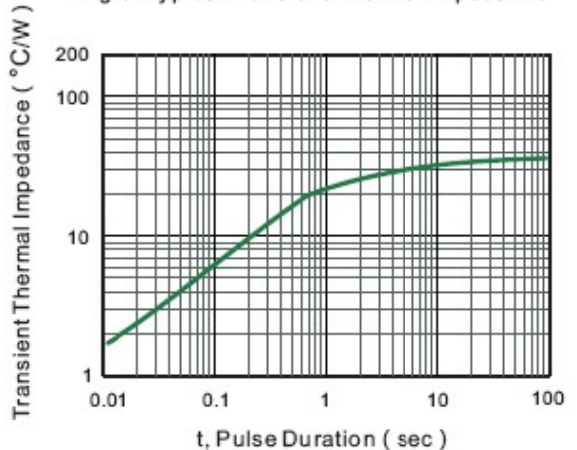

Fig.6- Typical Transient Thermal Impedance



SK MAKE CONSCIOUS PRODUCT

CONSCIOUS PRODUCTS BEGIN WITH CONSCIOUS PEOPLE



PACKAGE OUTLINE

Plastic surface mounted package; 2 leads

SMAF

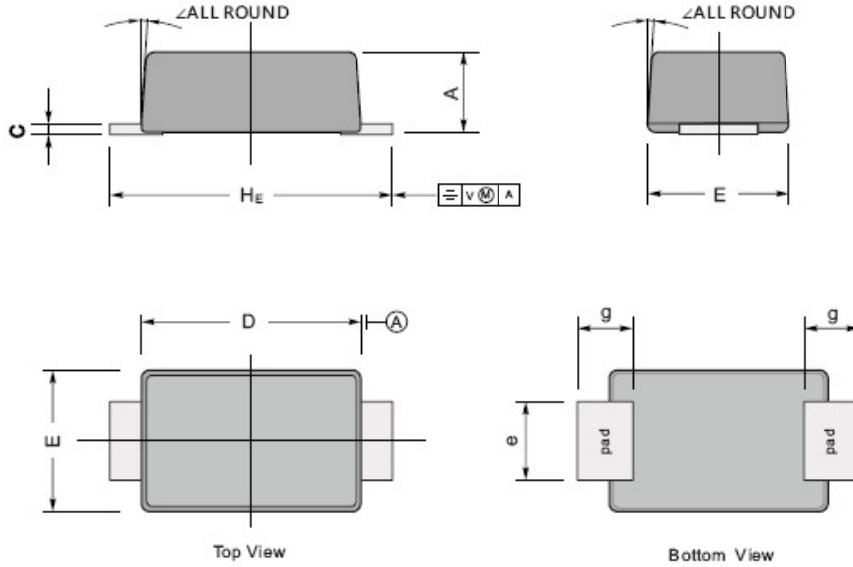

UNIT		A	C	D	E	e	g	H_E	\angle
mm	max	1.3	0.23	3.7	2.7	1.6	1.3	4.9	7°
	min	1.1	0.18	3.3	2.4	1.3	1.0	4.4	
mil	max	51	9.1	146	106	63	51	193	
	min	43	7.1	130	94	51	39	173	

The recommended mounting pad size

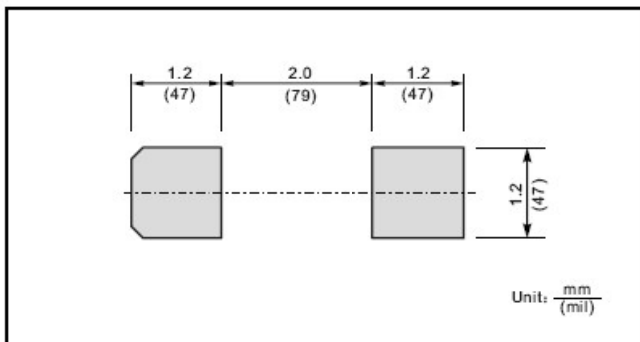

Marking

Type number	Marking code
SS32F	SS32
SS34F	SS34
SS36F	SS36
SS38F	SS38
SS310F	SS310
SS312F	SS312
SS315F	SS315
SS320F	SS320

SK MAKE CONSCIOUS PRODUCT

CONSCIOUS PRODUCTS BEGIN WITH CONSCIOUS PEOPLE

Rev:06

