



# ST1633

---

## Capacitive Touch Screen Controller

---

### Datasheet

Version 1.6

2015/11/17

Note: Sitronix Technology Corp. reserves the right to change the contents in this document without prior notice. This is not a final specification. Some parameters are subject to change.

## **1 INTRODUCTION**

The ST1633 is a mutual capacitive sensing controller for small size projected capacitive touch screen. It is a RISC microcontroller with capacitor charge, capacitor sensing, slave I2C interface, general purpose I/O and embedded non-volatile memory.

Internal program and cooperating digital circuit convert finger / capacitor stylus physical touching into button pressing message or multiple coordination information for application. The maximum fingers identification ability is up to five.

The ST1633 uses low profile QFN package and support ITO electrode on glass or film substrate. Hence, slim and small touch panel module is realizable.

And more, low electromagnetic interference of ST1633 makes it suitable for modern touch screen application which contain a vivid and high density display, like smart phone, portable navigation device and touch-enabled media player, etc..

Sitronix

Confidential

## FEATURES

- **MCU based touch controller**
- **Operation voltage**
  - VDD = 2.7V ~ 3.6V
  - IOVDD = 1.6V ~ 3.6V
- **Operation Temperature: -20°C ~ 80°C**
- **Storage Temperature: -40°C ~ 125°C**
- **Interface**
  - I2C (slave)
  - SPI
- **Sensor**
  - 21TX, 12 RX
- **Single finger handwriting**
- **five fingers detection and tracking**
- **Capacitive Sensor**
  - Mutual-capacitance sensing
  - Report rate : 100Hz
  - Hardware noise reduction
  - Waterproof circuit

- **Package**
  - QFN48

## APPLICATIONS

- Cell phones
- PDAs
- Portable instruments
- Touch screen monitors
- Electrical papers
- Gaming machines
- Pointing devices
- PC peripherals

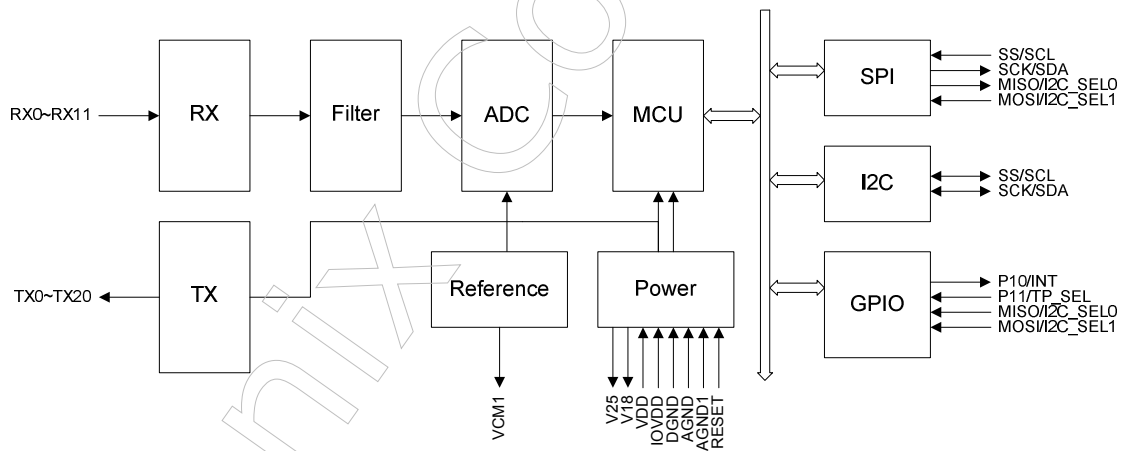

## 2 PACKAGE INFORMATION

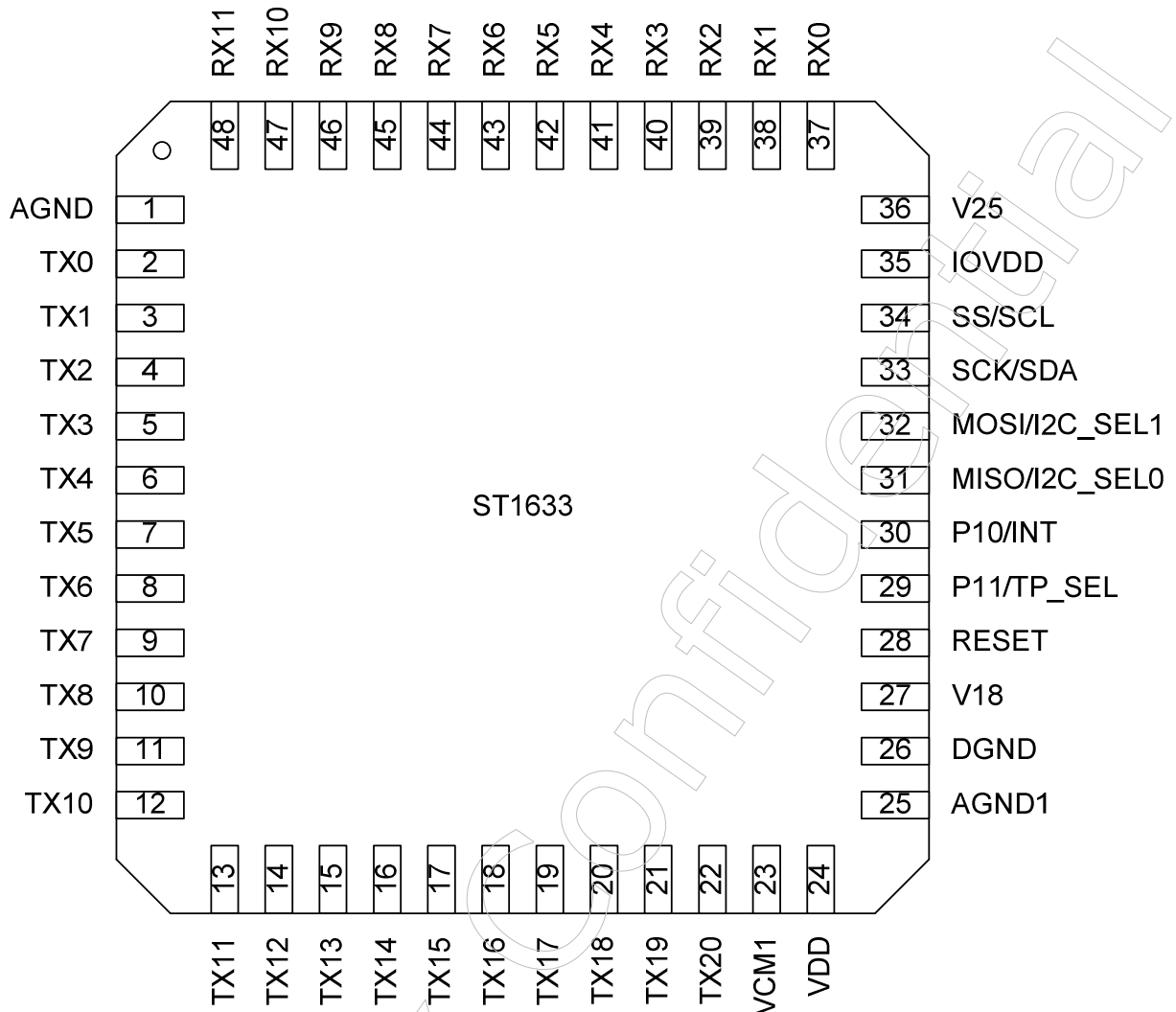

Figure 2-1 ST1633 Package Pin Configuration

Table 2-1 ST1633 Package Signal Descriptions

Pin #	Pin Name	I/O	Description
1	AGND	P	Analog ground
22~2	TX20~TX0	O	Transmitter channel
23	VCM1	P	Common mode voltage, connect to 1uF capacitor
24	VDD	P	Power supply, connect to 1uF capacitor
25	AGND1	P	Analog ground
26	DGND	P	Digital ground
27	V18	P	Digital power, connect to 1uF capacitor
28	RESET	I	System reset signal input, active low
29	P11/TP_SEL	I/O	P11 : General purpose I/O TP_SEL : Touch panel sensor select
30	P10/INT	I/O	P10 : General purpose I/O INT : Indicate coordinate data ready
31	MISO/ I2C_SEL0	I/O	MISO : SPI master input/slave output I2C_SEL0 : I2C address select
32	MOSI/ I2C_SEL1	I/O	MOSI : SPI master output/slave input I2C_SEL1 : I2C address select
33	SCK/SDA	I/O	SCK: SPI serial clock SDA: I2C serial data
34	SS/SCL	I/O	SS : SPI slave select SCL : I2C serial clock
35	IOVDD	P	I/O power supply, connect to 1uF capacitor
36	V25	P	Analog power, connect to 1uF capacitor
48~37	RX11~RX0	I	Receiver channel

Note: I/O type: P=Power pin, I=Input pin, O=Output pin

### 3 SYSTEM MANAGEMENT

#### 3.1 Power Down

In power down mode, all of the clocks of ST1633 are stopped. The way to exit power down mode is by a hardware reset or I2C.

#### 3.2 Reset

Master can reset ST1633 through RESET pin. RESET pin is low active and needs hold low for 1us to take effect.

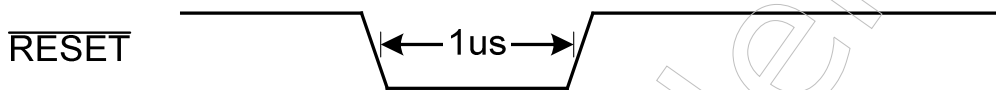

Figure 3-1  $\overline{\text{RESET}}$  Pin Low Pulse Width

#### 3.3 Power On/Off Sequence

RESET pin should be held low before power on and power off. During power on, after both VDD and IOVDD reach normal voltage, RESET pin needs to be held low for 5ms to ensure internal block stable.

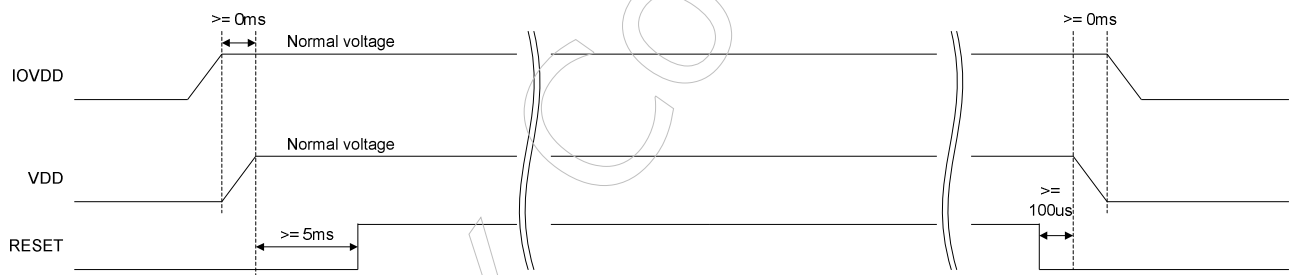

Figure 3-2 Power On/Off Sequence

## 4 DIGITAL INTERFACE

### 4.1 I2C Slave Interface

ST1633 equipped with I2C provides two wires, serial data (SDA) and serial clock (SCL), to carry transferring information at up to 400 kbit/s(Fast mode). ST1633 plays the slave role in I2C transfer. Both SDA and SCL are bidirectional lines, connected to IOVDD via pull-up resistors. All transactions begin with a START (S) and can be terminated by a STOP (P). 7-bits address follows START to recognize device. Each byte is 8-bits length and followed by an acknowledge bit. A HIGH to LOW transition on the SDA line while SCL is HIGH defines a START condition. A LOW to HIGH transition on the SDA line while SCL is HIGH defines a STOP condition. The data on the SDA line must be stable during the HIGH period of the clock. The HIGH or LOW state of the data line can only change when the clock signal on the SCL line is LOW.

#### Read

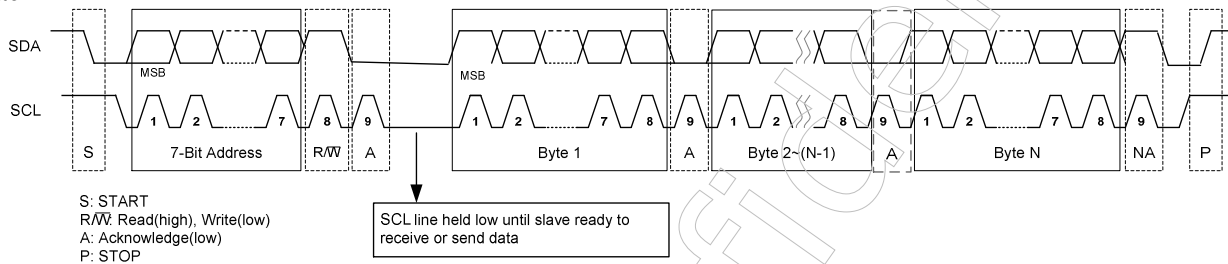

#### Write

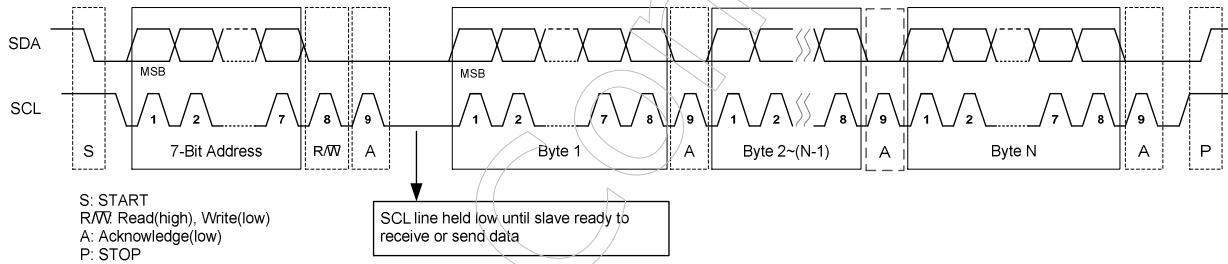

Figure 4-1 I2C Waveform

## 5 ELECTRICAL CHARACTERISTIC

### 5.1 Absolute Maximum Ratings

Table 5-1 Absolute Maximum Ratings

Parameter	Symbol	Min.	Max.	Unit
VDD	$V_{VDD}$	-0.3	+6	V
IOVDD	$V_{IOVDD}$	-0.3	+6	V
Operating Ambient Temperature	$T_A$	-20	+80	°C
Storage Temperature	$T_S$	-40	+125	°C

**\*Note:** Stresses above those listed under "Absolute Maximum Ratings" may cause permanent damage to the device. All the ranges are stress ratings only. Functional operation of this device at these or any other conditions above those indicated in the operational sections of this specification is not implied or intended. Exposed to the absolute maximum rating conditions for extended periods may affect device reliability.

### 5.2 DC Electrical Characteristics

Table 5-2 System DC Electrical Characteristics

Condition: VDD = IOVDD = 3.3V,  $T_A = 25^\circ\text{C}$ , unless be specified individually.

Parameter	Symbol	Min.	Typ.	Max.	Unit	Condition
VDD	$V_{VDD}$	2.7	-	3.6	V	
IOVDD	$V_{IOVDD}$	1.6	-	3.6	V	
Operating Current	$I_{NML}$	-	16.1	24	mA	21TX, 12RX
Idle Current	$I_{IDLE}$	-	8.1	12.2	mA	21TX, 12RX, scan rate=20Hz
Power Down Current	$I_{PD}$	-	-	20	uA	
Input High Voltage	$V_{IH}$	$0.85 \times I_{OVDD}$	-	-	V	
Input Low Voltage	$V_{IL}$	-	-	$0.15 \times I_{OVDD}$	V	
Input Pull Up Resistor	$R_{PU}$	50	-	60	KOhm	
Output Driving Current	$I_{DRV}$	6	-	-	mA	$V_{OH} = IOVDD \times 0.8$
Output Sinking Current	$I_{SINK}$	10	-	-	mA	$V_{OL} = IOVDD \times 0.2$
Low Voltage Reset	$V_{LVR}$	-	-	2.3	V	



5.3 AC Electrical Characteristics

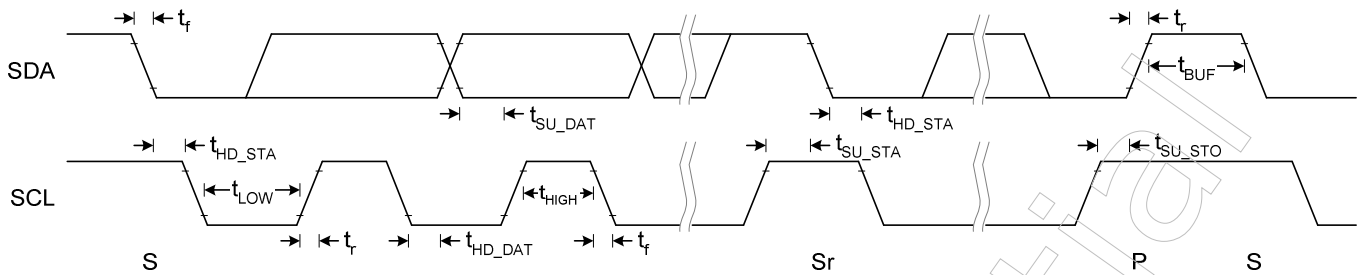

Figure 5-1 I2C Fast Mode Timing

Table 5-3 I2C Fast Mode Timing Characteristic

Conditions: VDD = 3.3V, GND = 0V, T<sub>A</sub> = 25°C

Symbol	Parameter	Rating			Unit
		Min.	Typ.	Max.	
f <sub>SCL</sub>	SCL clock frequency	0	-	400	kHz
t <sub>LOW</sub>	Low period of the SCL clock	1.3	-	-	us
t <sub>HIGH</sub>	High period of the SCL clock	0.6	-	-	us
t <sub>f</sub>	Signal falling time	-	-	300	ns
t <sub>r</sub>	Signal rising time	-	-	300	ns
t <sub>SU_STA</sub>	Set up time for a repeated START condition	0.6	-	-	us
t <sub>HD_STA</sub>	Hold time (repeated) START condition. After this period, the first clock pulse is generated	0.6	-	-	us
t <sub>SU_DAT</sub>	Data set up time	100	-	-	ns
t <sub>HD_DAT</sub>	Data hold time	0	-	0.9	us
t <sub>SU_STO</sub>	Set up time for STOP condition	0.6	-	-	us
t <sub>BUF</sub>	Bus free time between a STOP and START condition	1.3	-	-	us
C <sub>b</sub>	Capacitive load for each bus line	-	-	400	pF

## 6 APPLICATION CIRCUITS

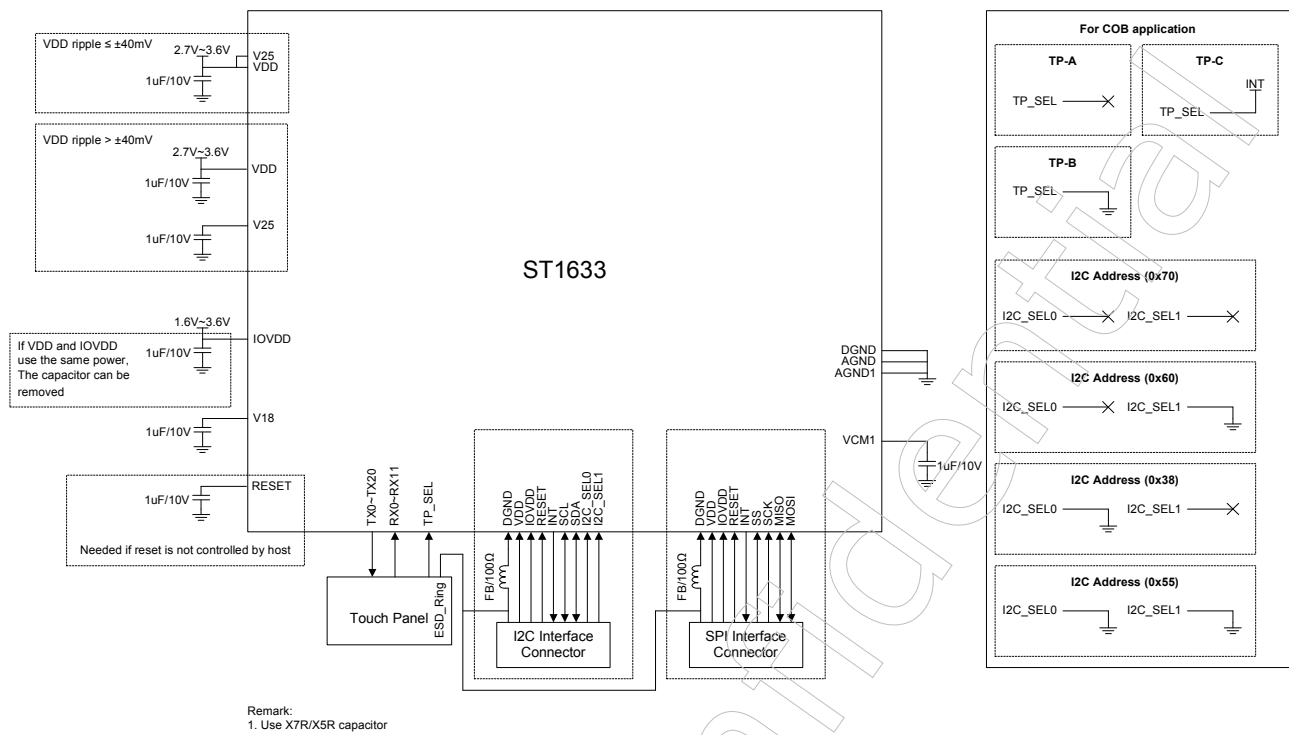

Figure 6-1 ST1633 Application Circuit

7 PACKAGE DIMENSION

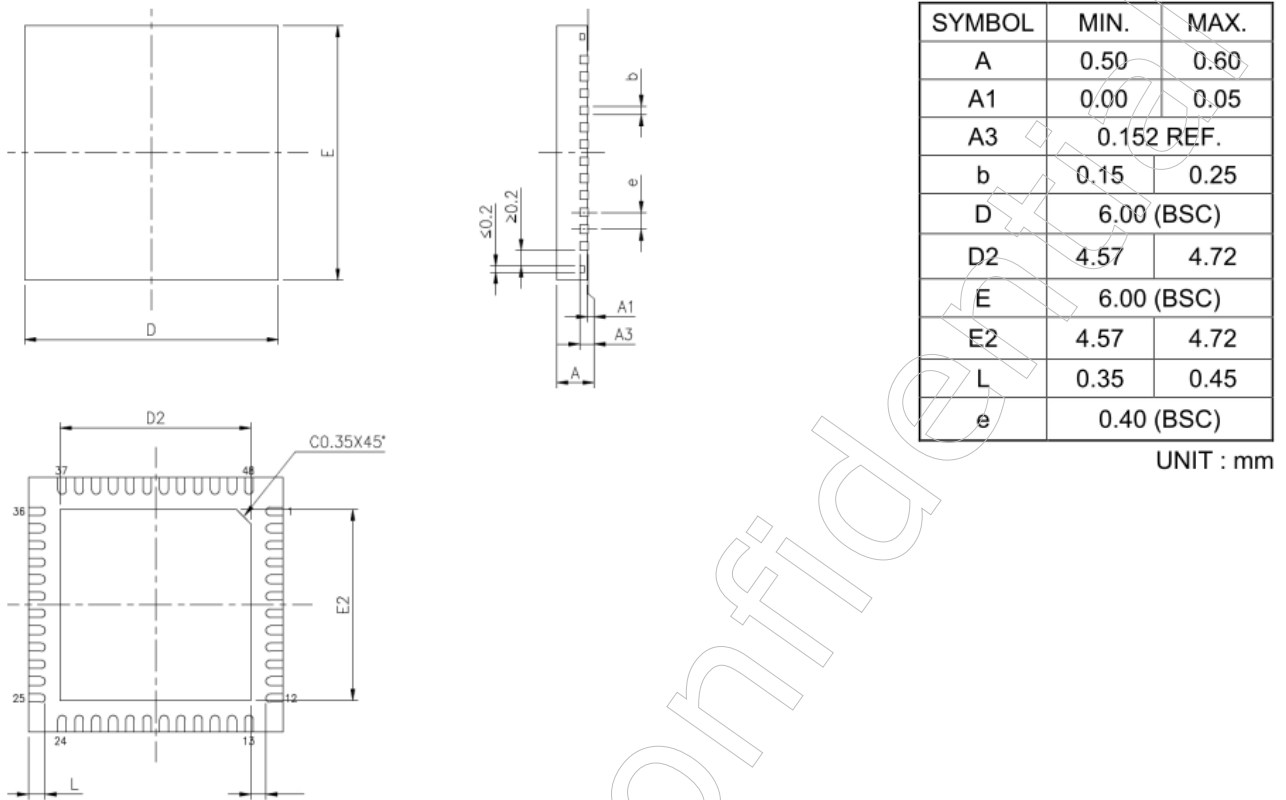

Figure 7-1 ST1633 Package Dimension

## 8 REVISION

REVISION	DESCRIPTION	PAGE	DATE
1.6	<ul style="list-style-type: none"> <li>■ Remove "max. loading: 30 kOhm/60pF" in feature</li> <li>■ Remove "IOVDD=3.3V" condition in VIH/VIL DC characteristic</li> <li>■ Add two different V25 circuit in application circuit</li> <li>■ Add "For COB application" note in application circuit</li> </ul>	3	2015/11/17
		8	
		10	
		10	
1.5	<ul style="list-style-type: none"> <li>■ Add block diagram</li> <li>■ P11 renamed to P11/TP_SEL, MISO renamed to MISO/I2C_SEL0, MOSI renamed to MOSI/I2C_SEL1</li> <li>■ Add power on/off sequence</li> <li>■ Modify I/O driving current to 6mA, sinking current to 10mA</li> <li>■ Modify application circuit</li> <li>■ Delete schematic example section</li> </ul>	3	2014/12/31
		4,5	
		6	
		8	
		10	
		-	
1.4	<ul style="list-style-type: none"> <li>■ Add operating/idle current data</li> </ul>	8	2014/10/22
1.3	<ul style="list-style-type: none"> <li>■ Modify operating temperature from -30~70 degree to -20~80 degree</li> </ul>	3,8	2014/07/14
1.2	<ul style="list-style-type: none"> <li>■ Modify application circuit and schematic example, V25 connected to VDD, remove V25 capacitor, add one bead between GND and host ground</li> </ul>	10,11	2014/02/24
1.1	<ul style="list-style-type: none"> <li>■ VDD/IOVDD/V18/V25/VCM1 capacitor changed to 1uF</li> <li>■ Add VOH/VOL description to system DC electrical characteristics table</li> <li>■ Add absolute maximum ratings</li> <li>■ Add schematic example</li> </ul>	5,10	2014/02/13
		8	
		8	
		11	
1.0	<ul style="list-style-type: none"> <li>■ First release</li> </ul>		2013/08/28

The above information is the exclusive intellectual property of Sitronix Technology Corp. and shall not be disclosed, distributed or reproduced without permission from Sitronix. Sitronix Technology Corp. reserves the right to change this document without prior notice and makes no warranty for any errors which may appear in this document. Sitronix products are not intended for use in life support, critical care, medical, safety equipment, or similar applications where products failure could result in injury, or loss of life, or personal or physical harm, or any military or defense application, or any governmental procurement to which special terms or provisions may apply.