

## UNIVERSAL ASYNCHRONOUS RECEIVER/TRANSMITTER

### DESCRIPTION

The ST16C450 is a universal asynchronous receiver and transmitter. A programmable baud rate generator is provided to select transmit and receive clock rates from 50Hz to 1.5 MHz.

The ST16C450 is an improved version of the NS16C450 UART with higher operating speed and lower access time. The ST16C450 on board status registers provides the error conditions, type and status of the transfer operation being performed. Included is complete MODEM control capability, and a processor interrupt system that may be software tailored to the user's requirements. The ST16C450 provides internal loop-back capability for on board diagnostic testing.

The ST16C450 is fabricated in an advanced 1.2μ CMOS process to achieve low drain power and high speed requirements.

### FEATURES

- Pin to pin and functional compatible to NS16450, VL16C450, WD16C450
- Modem control signals (CTS\*, RTS\*, DSR\*, DTR\*, RI\*, CD\*)
- Programmable character lengths (5, 6, 7, 8)
- Even, odd, or no parity bit generation and detection
- Status report register
- Independent transmit and receive control
- TTL compatible inputs, outputs
- 460.8 kHz transmit/receive operation with 7.372 MHz crystal or external clock source

### ORDERING INFORMATION

Part number	Package	Operating temperature
ST16C450CP40	Plastic-DIP	0° C to + 70° C
ST16C450CJ44	PLCC	0° C to + 70° C
ST16C450CQ48	TQFP	0° C to + 70° C

\* Industrial operating range are available.

### PLCC Package

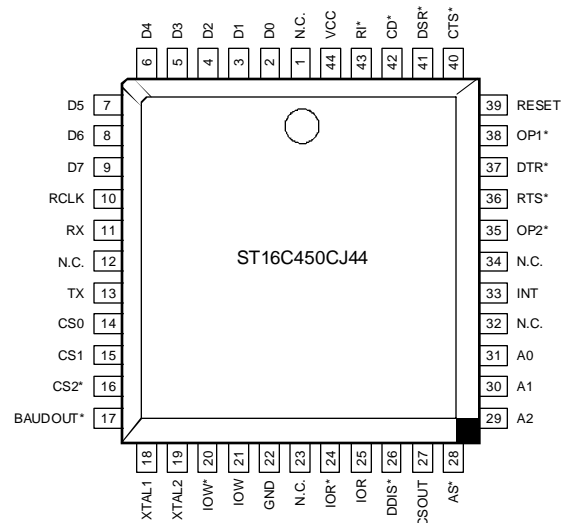

### Plastic-DIP Package

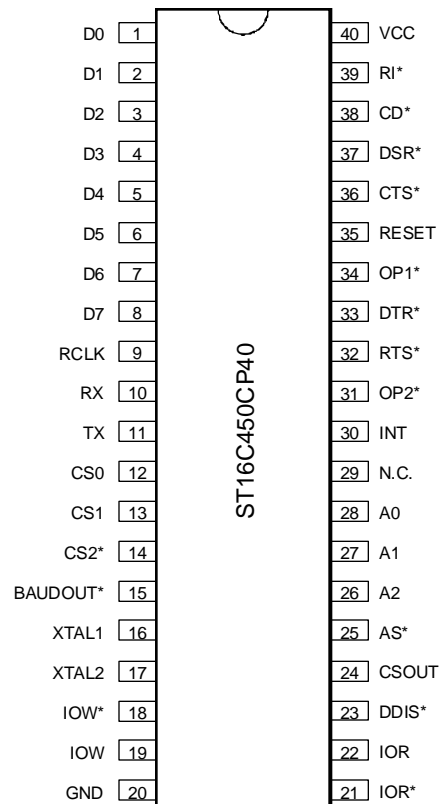

# ST16C450

## BLOCK DIAGRAM

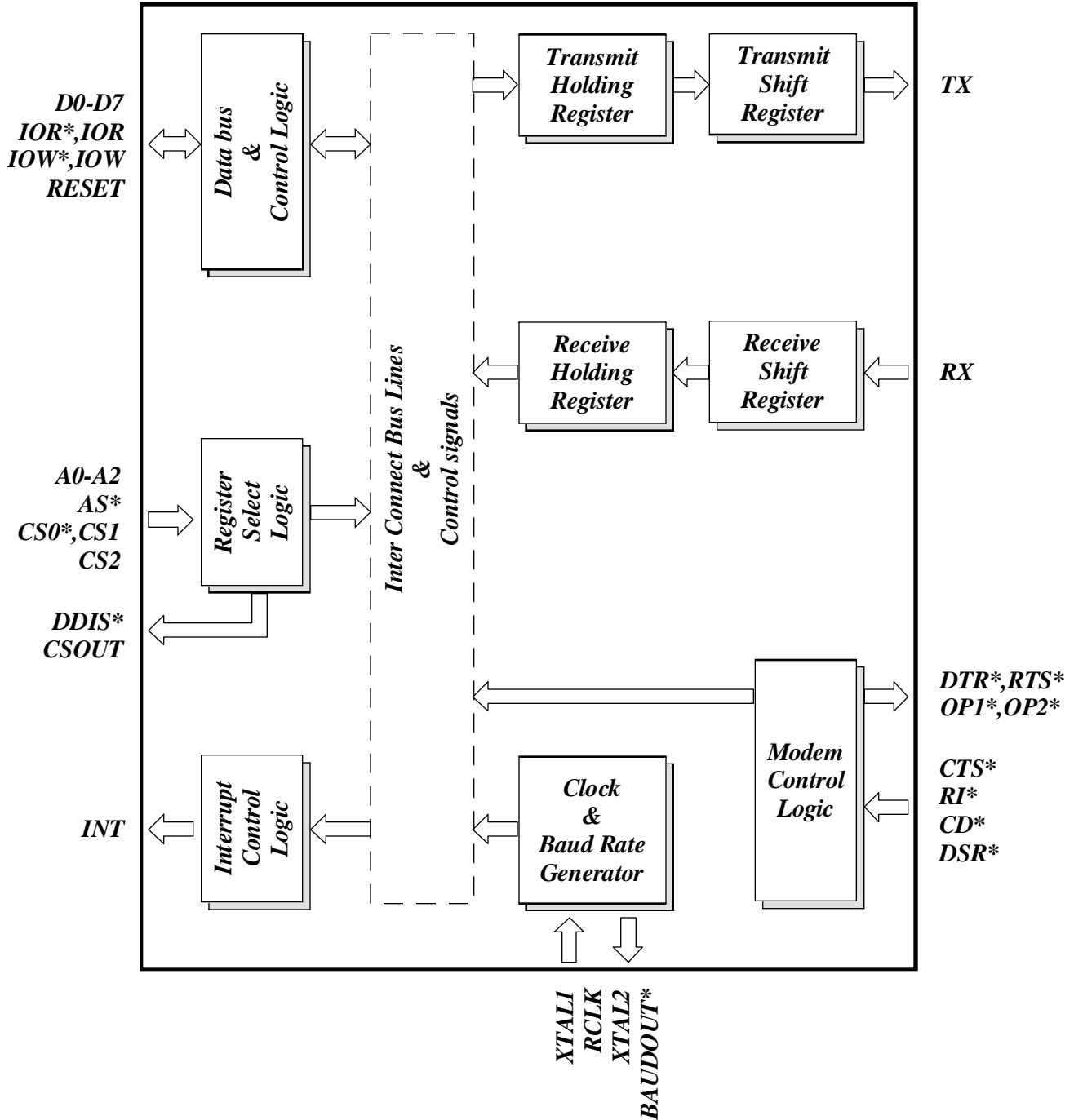

## SYMBOL DESCRIPTION

Symbol	Pin		Signal Type	Pin Description
	40	44		
D0-D7	1-8	2-9	I/O	Bi-directional data bus. Eight bit, three state data bus to transfer information to or from the CPU. D0 is the least significant bit of the data bus and the first serial data bit to be received or transmitted.
RCLK	9	10	I	Receive clock input. The external clock input to the ST16C450 receiver section if receiver data rate is different from transmitter data rate.
RX	10	11	I	Serial data input. The serial information (data) received from serial port to ST16C450 receive input circuit. A mark (high) is logic one and a space (low) is logic zero. During the local loopback mode the RX input is disabled from external connection and connected to the TX output internally.
TX	11	13	O	Serial data output. The serial data is transmitted via this pin with additional start, stop and parity bits. The TX will be held in mark (high) state during reset, local loopback mode or when the transmitter is disabled.
CS0	12	14	I	Chip select 1 (active high). A high at this pin enables the ST16C450 / CPU data transfer operation.
CS1	13	15	I	Chip select 2 (active high). A high at this pin enables the ST16C450 / CPU data transfer operation.
CS2*	14	16	I	Chip select 3 (active low). A low at this pin (while CS0=1 and CS1=1) will enable the ST16C450 / CPU data transfer operation.
BAUDOUT*	15	17	O	Baud rate generator clock output. This output provides the 16x clock of the internal selected baud rate. RCLK pin is connected externally to BAUDOUT* pin to provide the receiver clock.
XTAL1	16	18	I	Crystal input 1 or external clock input. A crystal can be connected to this pin and XTAL2 pin to utilize the internal oscillator circuit. An external clock can be used to clock internal circuit and baud rate generator for custom transmission rates.

# ST16C450

## SYMBOL DESCRIPTION

Symbol	Pin		Signal Type	Pin Description
	40	44		
XTAL2	17	19	O	Crystal input 2 or buffered clock output. See XTAL1.
IOW*	18	20	I	Write strobe (active low). A low on this pin will transfer the contents of the CPU data bus to the addressed register.
IOW	19	21	I	Write strobe (active high). Same as IOW*, but uses active high input. Note that only an active IOW* or IOW input is required to transfer data from CPU to ST16C450 during write operation. All the unused pin should be tied to VCC or GND.
GND	20	22	O	Signal and power ground.
IOR*	21	24	I	Read strobe (active low). A low level on this pin transfers the contents of the ST16C450 data bus to the CPU.
IOR	22	25	I	Read strobe (active high). Same as IOR*, but uses active high input. Note that only an active IOR* or IOR input is required to transfer data from ST16C450 to CPU during read operation. All the unused pin should be tied to VCC or GND.
DDIS*	23	26	O	Drive disable (active low). This pin goes low when the CPU is reading data from the ST16C450 to disable the external transceiver or logic's.
CSOUT	24	27	O	Chip select out. A high on this pin indicates that the ST16C450 has been enabled by the chip select pin.
AS*	25	28	I	Address strobe (active low). A low on this pin will latch the state of the chip selects and addressed register (A2-A0). This input is used when signals are not stable for the duration of a read or write operation. If not required, tie the AS* input permanently low.
A2	26	29	I	Address select line 2. To select internal registers.
A1	27	30	I	Address select line 1. To select internal registers.
A0	28	31	I	Address select line 0. To select internal registers.

## SYMBOL DESCRIPTION

Symbol	Pin		Signal Type	Pin Description
	40	44		
INT	30	33	O	Interrupt output (active high). This pin goes high (when enabled by the interrupt enable register) whenever a receiver error, receiver data available, transmitter empty, or modem status condition flag is detected.
OP2*	31	35	O	General purpose output (active low). User defined output. See bit-3 modem control register (MCR bit-3).
RTS*	32	36	O	Request to send (active low). To indicate that the transmitter has data ready to send. Writing a "1" in the modem control register (MCR bit-1 ) will set this pin to a low state. After the reset this pin will be set to high. Note that this pin does not have any effect on the transmit or receive operation.
DTR*	33	37	O	Data terminal ready (active low). To indicate that ST16C450 is ready to receive data. This pin can be controlled via the modem control register (MCR bit-0). Writing a "1" at the MCR bit-0 will set the DTR* output to low. This pin will be set to high state after writing a "0" to that register or after the reset . Note that this pin does not have any effect on the transmit or receive operation.
OP1*	34	38	O	General purpose output (active low). User defined output. See bit-2 of modem control register (MCR bit-2).
RESET	35	39	I	Master reset (active high). A high on this pin will reset all the outputs and internal registers. The transmitter output and the receiver input will be disabled during reset time.
CTS*	36	40	I	Clear to send (active low). The CTS* signal is a MODEM control function input whose conditions can be tested by reading the MSR BIT-4. CTS* has no effect on the transmit or receive operation.
DSR*	37	41	I	Data set ready (active low). A low on this pin indicates the MODEM is ready to exchange data with UART. This pin does not have any effect on the transmit or receive operation.

# ST16C450

---

## SYMBOL DESCRIPTION

Symbol	Pin		Signal Type	Pin Description
	40	44		
CD*	38	42	I	Carrier detect (active low). A low on this pin indicates the carrier has been detected by the modem.
RI*	39	43	I	Ring detect indicator (active low). A low on this pin indicates the modem has received a ringing signal from telephone line.
VCC	40	44	I	Power supply input.

All unused input pins should be tied to VCC or GND.

## PROGRAMMING TABLE

A2	A1	A0	READ MODE	WRITE MODE
0	0	0	Receive Holding Register	Transmit Holding Register
0	0	1		Interrupt Enable Register
0	1	0	Interrupt Status Register	
0	1	1		Line Control Register
1	0	0		Modem Control Register
1	0	1	Line Status Register	
1	1	0	Modem Status Register	
1	1	1	Scratchpad Register	Scratchpad Register
0	0	0		LSB of Divisor Latch
0	0	1		MSB of Divisor Latch

## ST16C450 ACCESSIBLE REGISTERS

A2 A1 A0	Register	BIT-7	BIT-6	BIT-5	BIT-4	BIT-3	BIT-2	BIT-1	BIT-0
0 0 0	RHR	bit-7	bit-6	bit-5	bit-4	bit-3	bit-2	bit-1	bit-0
0 0 0	THR	bit-7	bit-6	bit-5	bit-4	bit-3	bit-2	bit-1	bit-0
0 0 1	IER	0	0	0	0	modem status interrupt	receive line status interrupt	transmit holding register	receive holding register
0 1 0	ISR	0	0	0	0	0	int priority bit-1	int priority bit-0	int status
0 1 1	LCR	divisor latch enable	set break	set parity	even parity	parity enable	stop bits	word length bit-1	word length bit-0
1 0 0	MCR	0	0	0	loop back	OP2*	OP1*	RTS*	DTR*
1 0 1	LSR	0	trans. empty	trans. holding empty	break interrupt	framing error	parity error	overrun error	receive data ready
1 1 0	MSR	CD	RI	DSR	CTS	delta CD*	delta RI*	delta DSR*	delta CTS*
1 1 1	SPR	bit-7	bit-6	bit-5	bit-4	bit-3	bit-2	bit-1	bit-0
<b>0 0 0</b>	<b>DLL</b>	<b>bit-7</b>	<b>bit-6</b>	<b>bit-5</b>	<b>bit-4</b>	<b>bit-3</b>	<b>bit-2</b>	<b>bit-1</b>	<b>bit-0</b>
<b>0 0 1</b>	<b>DLM</b>	<b>bit-15</b>	<b>bit-14</b>	<b>bit-13</b>	<b>bit-12</b>	<b>bit-11</b>	<b>bit-10</b>	<b>bit-9</b>	<b>bit-8</b>

*DLL and DLM are accessible only when LCR bit-7 is set to "1".*

# ST16C450

## REGISTER FUNCTIONAL DESCRIPTIONS

### TRANSMIT AND RECEIVE HOLDING REGISTER

The serial transmitter section consists of a Transmit Hold Register (THR) and Transmit Shift Register (TSR). The status of the transmit hold register is provided in the Line Status Register (LSR). Writing to this register (THR) will transfer the contents of data bus (D7-D0) to the Transmit holding register whenever the transmitter holding register or transmitter shift register is empty. The transmit holding register empty flag will be set to "1" when the transmitter is empty or data is transferred to the transmit shift register. Note that a write operation should be performed when the transmit holding register empty flag is set.

On the falling edge of the start bit, the receiver internal counter will start to count 7 1/2 clocks (16x clock) which is the center of the start bit. The start bit is valid if the RX is still low at the mid-bit sample of the start bit. Verifying the start bit prevents the receiver from assembling a false data character due to a low going noise spike on the RX input. Receiver status codes will be posted in the Line Status Register.

### PROGRAMMABLE BAUD RATE GENERATOR

The ST16C450 contains a programmable Baud Rate Generator that is capable of taking any clock input from DC-24 MHz and dividing it by any divisor from 1 to  $2^{16} - 1$ . The output frequency of the Baudout\* is equal to  $16X$  of transmission baud rate (Baudout\* =  $16 \times$  Baud Rate). Customize Baud Rates can be achieved by selecting proper divisor values for MSB and LSB of baud rate generator.

### INTERRUPT ENABLE REGISTER (IER)

The Interrupt Enable Register (IER) masks the incoming interrupts from receiver ready, transmitter empty, line status and modem status registers to the INT output pin.

#### IER BIT-0:

0=disable the receiver ready interrupt.  
1=enable the receiver ready interrupt.

#### IER BIT-1:

0=disable the transmitter empty interrupt.  
1=enable the transmitter empty interrupt.

#### IER BIT-2:

0=disable the receiver line status interrupt.  
1=enable the receiver line status interrupt.

#### IER BIT-3:

0=disable the modem status register interrupt.  
1=enable the modem status register interrupt.

#### IER BIT 7-4:

All these bits are set to logic zero.

### INTERRUPT STATUS REGISTER (ISR)

The ST16C450 provides four level prioritized interrupt conditions to minimize software overhead during data character transfers. The Interrupt Status Register (ISR) provides the source of the interrupt in prioritized matter. During the read cycle the ST16C450 provides the highest interrupt level to be serviced by CPU. No other interrupts are acknowledged until the particular interrupt is serviced. The following are the prioritized interrupt levels:

#### Priority level

P	D2	D1	D0	Source of the interrupt
1	1	1	0	LSR (Receiver Line Status Register)
2	1	0	0	RXRDY (Received Data Ready)
3	0	1	0	TXRDY( Transmitter Holding Register Empty)
4	0	0	0	MSR (Modem Status Register)



**ISR BIT-0:**

0=an interrupt is pending and the ISR contents may be used as a pointer to the appropriate interrupt service routine.

1=no interrupt pending.

**ISR BIT 1-2:**

Logical combination of these bits, provides the highest priority interrupt pending.

**ISR BIT 3-7:**

These bits are not used and are set to "0".

**LINE CONTROL REGISTER (LCR)**

The Line Control Register is used to specify the asynchronous data communication format. The number of the word length, stop bits, and parity can be selected by writing appropriate bits in this register.

**LCR BIT1-0:**

These two bits specify the word length to be transmitted or received.

BIT-1	BIT-0	Word length
0	0	5
0	1	6
1	0	7
1	1	8

**LCR BIT-2:**

The number of stop bits can be specified by this bit.

BIT-2	Word length	Stop bit(s)
0	5,6,7,8	1
1	5	1-1/2
1	6,7,8	2

**LCR BIT-3:**

Parity or no parity can be selected via this bit.

0=no parity

1=a parity bit is generated during the transmission, receiver also checks for received parity.

**LCR BIT-4:**

If the parity bit is enabled, LCR BIT-4 selects the even or odd parity format.

0=ODD parity is generated by forcing an odd number of 1's in the transmitted data, receiver also checks for same format.

1= EVEN parity bit is generated by forcing an even the number of 1's in the transmitted data, receiver also checks for same format.

**LCR BIT-5:**

If the parity bit is enabled, LCR BIT-5 selects the forced parity format.

LCR BIT-5=1 and LCR BIT-4=0, parity bit is forced to "1" in the transmitted and received data.

LCR BIT-5=1 and LCR BIT-4=1, parity bit is forced to "0" in the transmitted and received data.

**LCR BIT-6:**

Break control bit. It causes a break condition to be transmitted (the TX is forced to low state).

0=normal operating condition.

1=forces the transmitter output (TX) to go low to alert the communication terminal.

**LCR BIT-7:**

The internal baud rate counter latch enable (DLEN).

0=normal operation.

1=select divisor latch register.

**MODEM CONTROL REGISTER (MCR)**

This register controls the interface with the MODEM or a peripheral device (RS232).

**MCR BIT-0:**

0=force DTR\* output to high.

1=force DTR\* output to low.

# ST16C450

---

## MCR BIT-1:

0=force RTS\* output to high.  
1=force RTS\* output to low.

## MCR BIT-2:

0=set OP1\* output to high.  
1=set OP1\* output to low.

## MCR BIT-3:

0=set OP2\* output to high.  
1=set OP2\* output to low.

## MCR BIT-4:

0=normal operating mode.  
1=enable local loop-back mode (diagnostics). The transmitter output (TX) is set high (Mark condition), the receiver input (RX), CTS\*, DSR\*, CD\*, and RI\* are disabled. Internally the transmitter output is connected to the receiver input and DTR\*, RTS\*, OP1\* and OP2\* are connected to modem control inputs. In this mode, the receiver and transmitter interrupts are fully operational. The Modem Control Interrupts are also operational, but the interrupt sources are now the lower four bits of the Modem Control Register instead of the four Modem Control inputs. The interrupts are still controlled by the IER.

## MCR BIT 5-7:

Not used. Are set to zero permanently.

## LINE STATUS REGISTER (LSR)

This register provides the status of data transfer to CPU.

### LSR BIT-0:

0=no data in receive holding register  
1=data has been received and saved in the receive holding register.

### LSR BIT-1:

0=no overrun error (normal).  
1=overrun error, next character arrived before receive holding register was emptied.

## LSR BIT-2:

0=no parity error (normal).  
1=parity error, received data does not have correct parity information.

## LSR BIT-3:

0=no framing error (normal).  
1=framing error received, received data did not have a valid stop bit. In

## LSR BIT-4:

0=no break condition (normal).  
1=receiver received a break signal (RX was low for one character time frame).

## LSR BIT-5:

0=transmit holding register is full. ST16C450 will not accept any data for transmission.  
1=transmit holding register is empty. CPU can load the next character.

## LSR BIT-6:

0=transmitter holding and shift registers are full.  
1=transmitter holding and shift registers are empty.

## LSR BIT-7:

Not used. Set to "0".

## MODEM STATUS REGISTER (MSR)

This register provides the current state of the control lines from the modem or peripheral to the CPU. Four bits of this register are used to indicate the changed information. These bits are set to "1" whenever a control input from the MODEM changes state. They are set to "0" whenever the CPU reads this register.

### MSR BIT-0:

Indicates that the CTS\* input to the ST16C450 has changed state since the last time it was read.

### MSR BIT-1:

Indicates that the DSR\* input to the ST16C450 has changed state since the last time it was read.

**MSR BIT-2:**

Indicates that the RI\* input to the ST16C450 has changed from a low to a high state.

**MSR BIT-3:**

Indicates that the CD\* input to the ST16C450 has changed state since the last time it was read.

**MSR BIT-4:**

This bit is equivalent to RTS in the MCR during local loop-back mode. It is the compliment of the CTS\* input.

**MSR BIT-5:**

This bit is equivalent to DTR in the MCR during local loop-back mode. It is the compliment of the DSR\* input.

**MSR BIT-6:**

This bit is equivalent to OP1 in the MCR during local loop-back mode. It is the compliment of the RI\* input.

**MSR BIT-7:**

This bit is equivalent to OP2 in the MCR during local loop-back mode. It is the compliment to the CD\* input.

Note: Whenever MSR BIT3-0: is set to logic "1", a MODEM Status Interrupt is generated.

**SCRATCHPAD REGISTER (SR)**

ST16C450 provides a temporary data register to store 8 bits of information for variable use.

SIGNAL	RESET STATE
TX	High
OP1*	High
OP2*	High
RTS*	High
DTR*	High
INT	Low

**BAUD RATE GENERATOR PROGRAMMING TABLE (1.8432 MHz CLOCK):**

BAUD RATE	16 x CLOCK DIVISOR	% ERROR
50	2304	
75	1536	
110	1047	0.026
134.5	857	0.058
150	768	
300	384	
600	192	
1200	96	
2400	48	
3600	32	
4800	24	
7200	16	
9600	12	
19.2K	6	
38.4K	3	
56K	2	2.77
115.2K	1	

**ST16C450 EXTERNAL RESET CONDITION**

REGISTERS	RESET STATE
IER	IER BITS 0-7=0
ISR	ISR BIT-0=1, ISR BITS 1-7=0
LCR	LCR BITS 0-7=0
MCR	MCR BITS 0-7=0
LSR	LSR BITS 0-4=0, LSR BITS 5-6=1 LSR, BIT 7=0
MSR	MSR BITS 0-3=0, MSR BITS 4-7=input signals

# ST16C450

## AC ELECTRICAL CHARACTERISTICS

$T_A=0^\circ - 70^\circ \text{ C}$ ,  $V_{CC}=5.0 \text{ V} \pm 10\%$  unless otherwise specified.

Symbol	Parameter	Limits			Units	Conditions
		Min	Typ	Max		
T <sub>1</sub>	Clock high pulse duration	20			ns	
T <sub>2</sub>	Clock low pulse duration	20			ns	
T <sub>3</sub>	Clock rise/fall time			10	ns	
T <sub>4</sub>	Baud out rise/fall time			100	ns	100 pF load
T <sub>5</sub>	Address strobe width	30			ns	
T <sub>6</sub>	Address setup time	15			ns	
T <sub>7</sub>	Address hold time	15			ns	
T <sub>8</sub>	Chip select setup time	0			ns	
T <sub>9</sub>	Chip select hold time	0			ns	
T <sub>10</sub>	CSOUT delay from chip select			10	ns	
T <sub>11</sub>	IOR* to DDIS* delay			35	ns	100 pF load
T <sub>12</sub>	Data setup time	15			ns	Note: 1
T <sub>13</sub>	Data hold time	15			ns	Note: 1
T <sub>14</sub>	IOW* delay from chip select	10			ns	Note: 1
T <sub>15</sub>	IOW* strobe width	55			ns	
T <sub>16</sub>	Chip select hold time from IOW*	0			ns	Note: 1
T <sub>17</sub>	Write cycle delay	55			ns	
T <sub>w</sub>	Write cycle= $T_{15}+T_{17}$	105			ns	
T <sub>19</sub>	Data hold time	15			ns	
T <sub>21</sub>	IOR* delay from chip select	25			ns	Note: 1
T <sub>23</sub>	IOR* strobe width	65			ns	
T <sub>24</sub>	Chip select hold time from IOR*	0			ns	Note: 1
T <sub>25</sub>	Read cycle delay	55			ns	
T <sub>r</sub>	Read cycle= $T_{23}+T_{25}$	115			ns	
T <sub>26</sub>	Delay from IOR* to data	25			ns	100 pF load
T <sub>28</sub>	Delay from IOW* to output			50	ns	100 pF load
T <sub>29</sub>	Delay to set interrupt from MODEM input			70	ns	100 pF load
T <sub>30</sub>	Delay to reset interrupt from IOR*			70	ns	100 pF load
T <sub>31</sub>	Delay from stop to set interrupt			1 <sub>Rclk</sub>	*	100 pF load
T <sub>32</sub>	Delay from IOR* to reset interrupt			200	ns	100 pF load
T <sub>33</sub>	Delay from initial INT reset to transmit start	8		24	*	

## AC ELECTRICAL CHARACTERISTICS

$T_A=0^\circ - 70^\circ \text{ C}$ ,  $V_{CC}=5.0 \text{ V} \pm 10\%$  unless otherwise specified.

Symbol	Parameter	Limits			Units	Conditions
		Min	Typ	Max		
$T_{34}$	Delay from stop to interrupt			100	ns	
$T_{35}$	Delay from IOW* to reset interrupt			175	ns	
$T_R$	Reset pulse width	10			ns	
N	Baud rate divisor	1		$2^{16-1}$		

Note 1: Applicable only when AS\* is tied low.

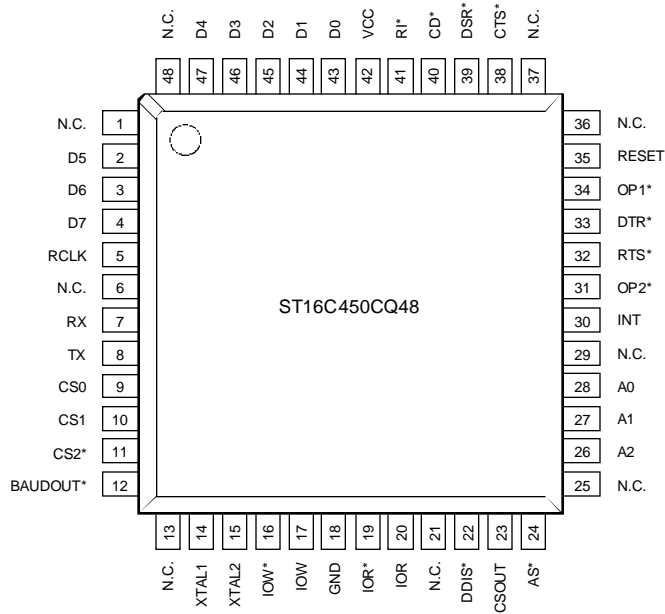

# ST16C450

## ABSOLUTE MAXIMUM RATINGS

Supply range	7 Volts
Voltage at any pin	GND-0.3 V to VCC+0.3 V
Operating temperature	0° C to +70° C
Storage temperature	-40° C to +150° C
Package dissipation	500 mW

## DC ELECTRICAL CHARACTERISTICS

$T_A=0^\circ - 70^\circ \text{C}$ ,  $V_{CC}=5.0 \text{ V} \pm 10\%$  unless otherwise specified.

Symbol	Parameter	Limits			Units	Conditions
		Min	Typ	Max		
$V_{ILCK}$	Clock input low level	-0.5		0.6	V	
$V_{IHCK}$	Clock input high level	3.0		VCC	V	
$V_{IL}$	Input low level	-0.5		0.8	V	
$V_{IH}$	Input high level	2.2		VCC	V	
$V_{OL}$	Output low level on all outputs			0.4	V	$I_{OL} = 6 \text{ mA}$
$V_{OH}$	Output high level	2.4			V	$I_{OH} = -6 \text{ mA}$
$I_{CC}$	Avg. power supply current		6		mA	
$I_{IL}$	Input leakage			$\pm 10$	$\mu\text{A}$	
$I_{CL}$	Clock leakage			$\pm 10$	$\mu\text{A}$	

This product can operate in 3.0 Volts environment. Please consult with factory for additional information.

## CLOCK TIMING

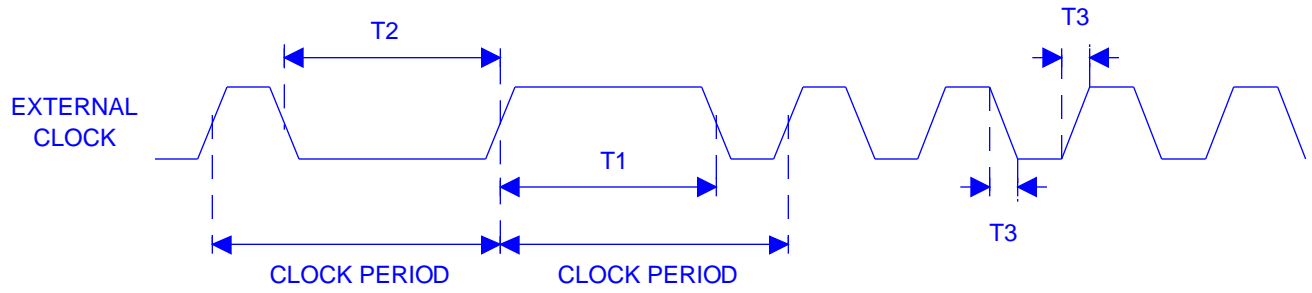

## BAUDOUT\* TIMING

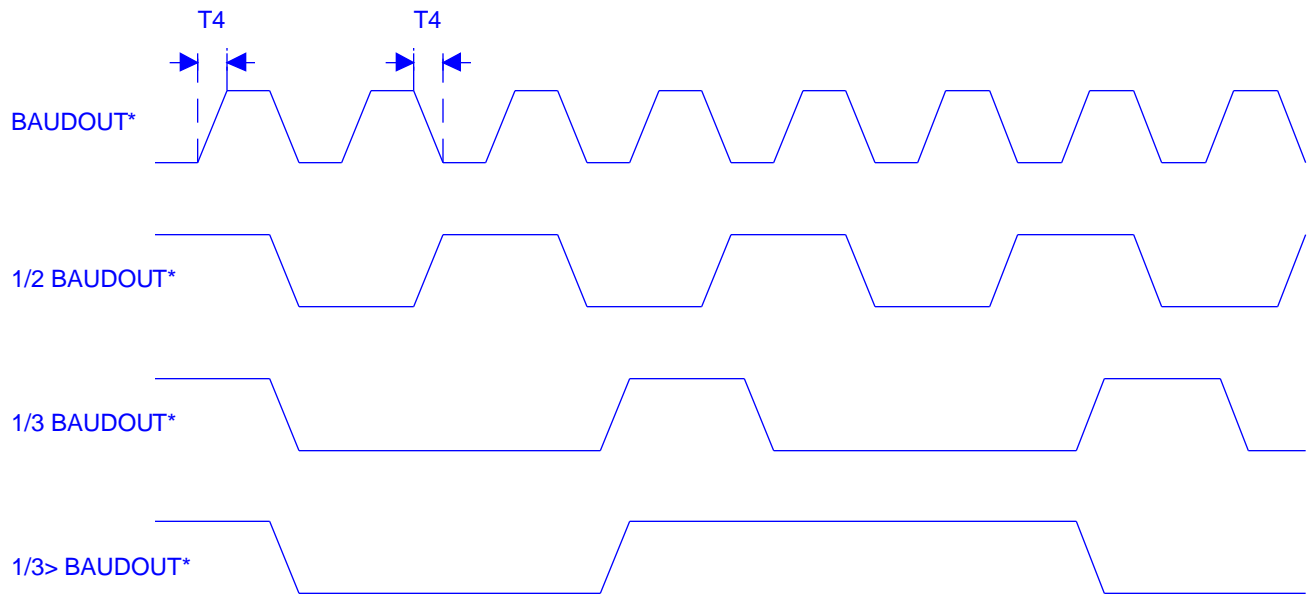

16450-CK-1

# ST16C450

## GENERAL READ TIMING

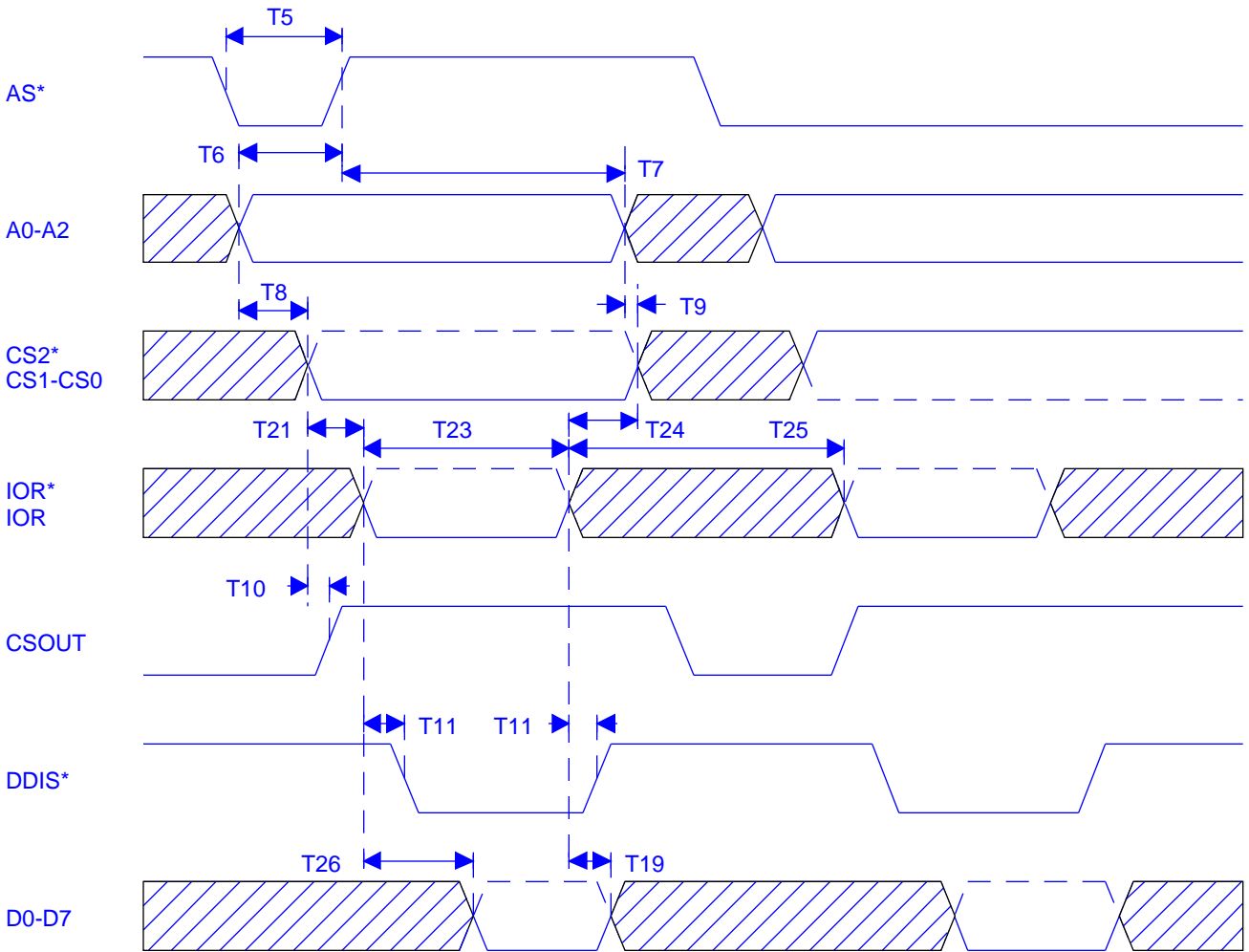

16450-RD-1



## GENERAL WRITE TIMING

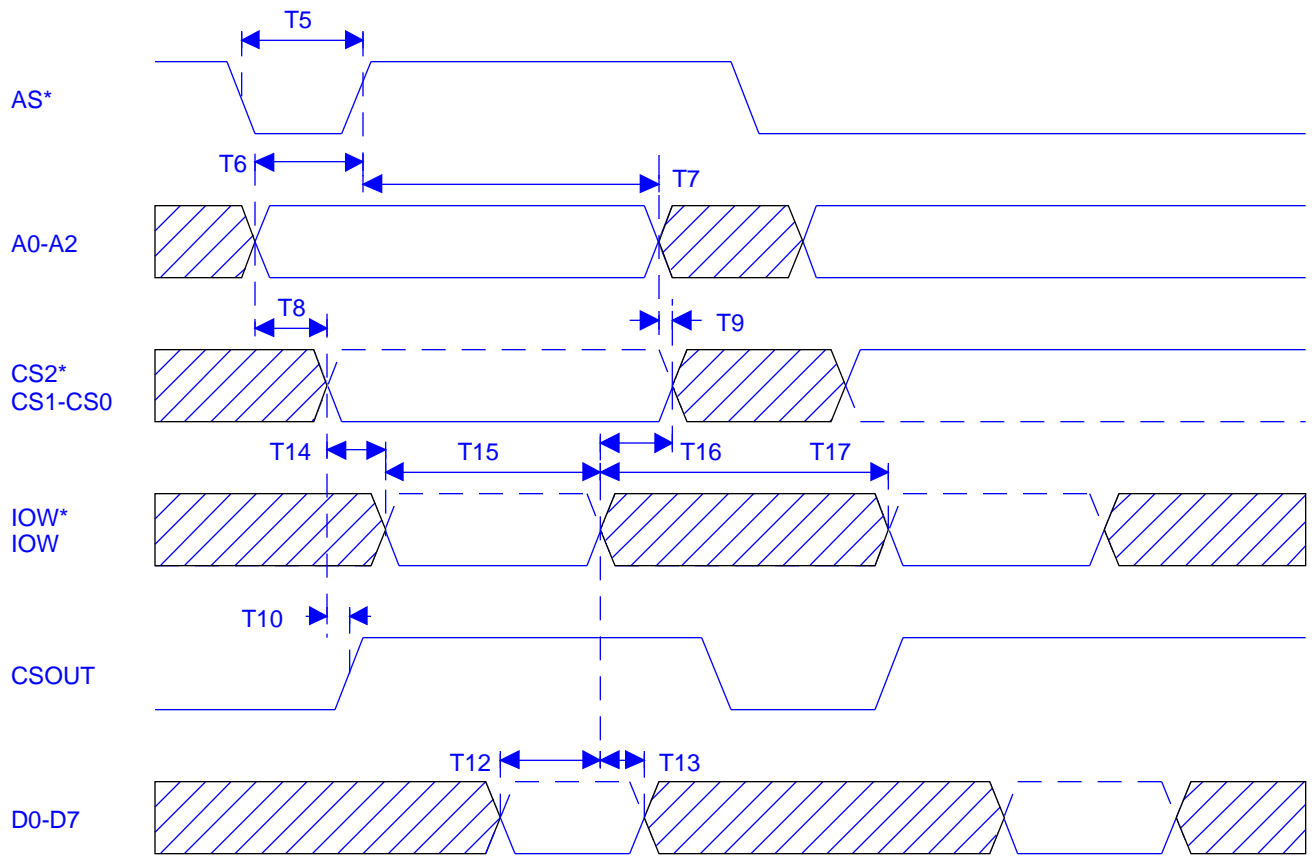

16450-WD-1

# ST16C450

## MODEM TIMING

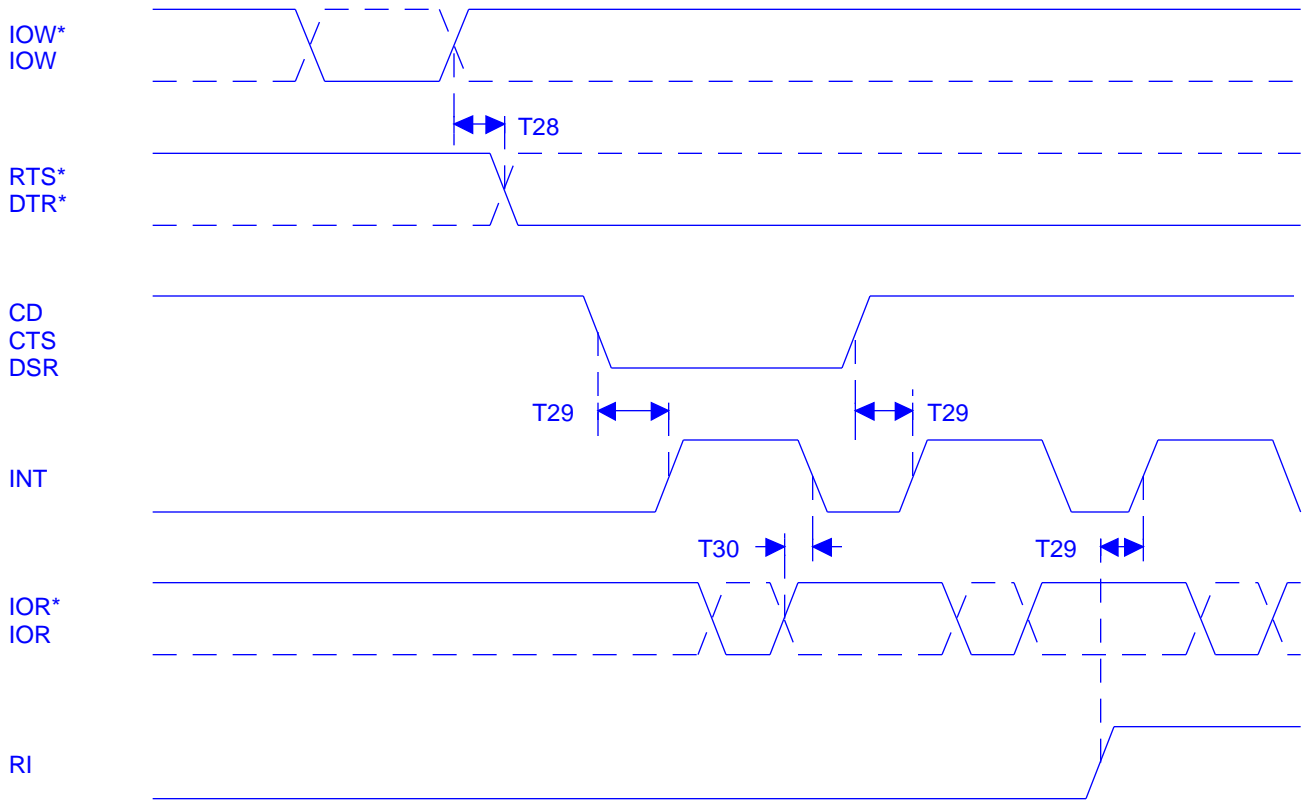

16450-MD-1

## RECEIVE TIMING

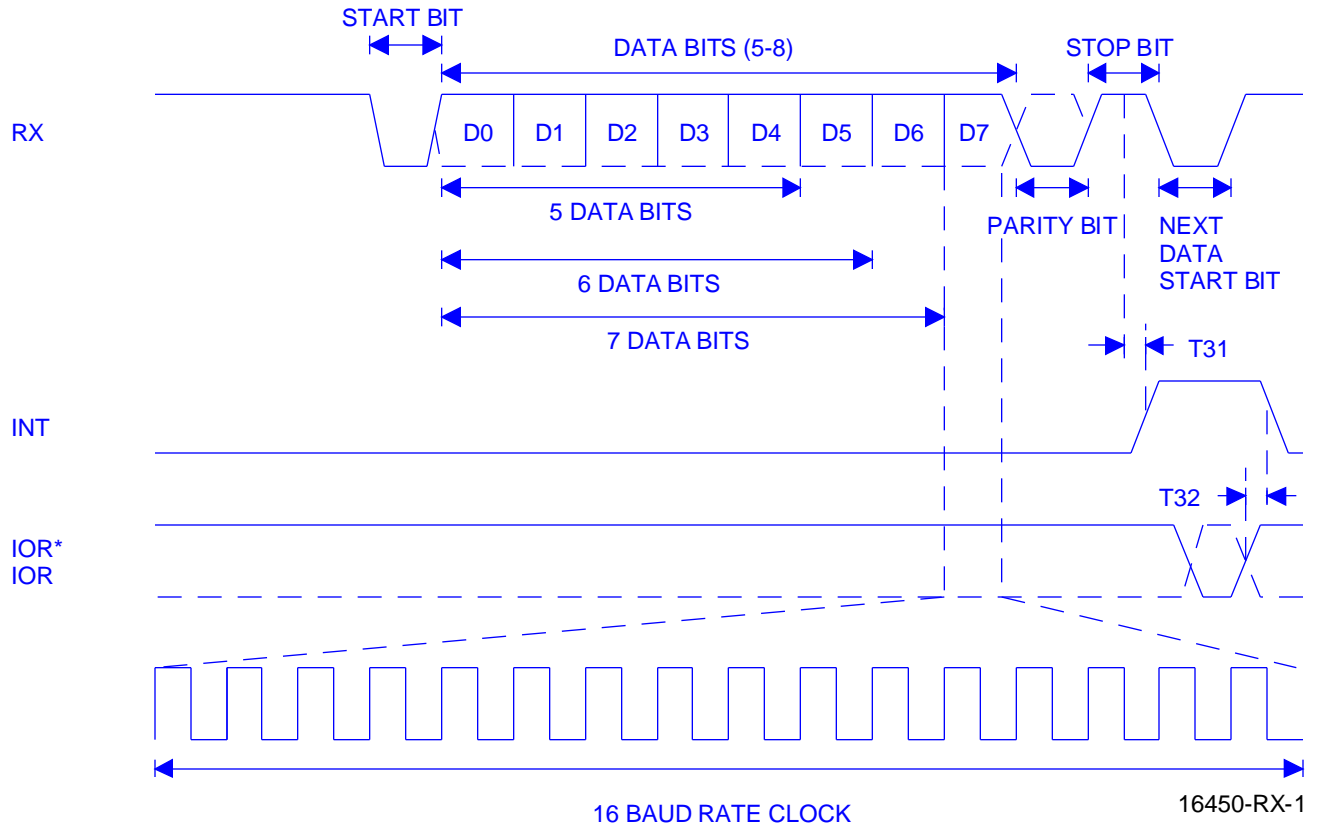

# ST16C450

## TRANSMIT TIMING

