



---

***DISCRETE POWER DIODES and THYRISTORS***  
***DATA BOOK***

---

**PHASE CONTROL THYRISTORS**
**Hockey Puk Version**
**Features**

- Center amplifying gate
- Metal case with ceramic insulator
- International standard case TO-200AB (A-PUK)
- Extended temperature range

**500A**
**Typical Applications**

- DC motor controls
- Controlled DC power supplies
- AC controllers



case style TO-200AB (A-PUK)

**Major Ratings and Characteristics**

Parameters	ST280CH..C	Units
$I_{T(AV)}$	500	A
	@ $T_{hs}$	80 °C
$I_{T(RMS)}$	1130	A
	@ $T_{hs}$	25 °C
$I_{TSM}$	@ 50Hz	7200 A
	@ 60Hz	7500 A
$I^2t$	@ 50Hz	260 KA <sup>2</sup> s
	@ 60Hz	230 KA <sup>2</sup> s
$V_{DRM}/V_{RRM}$	400 to 600	V
$t_q$ typical	100	μs
$T_J$	- 40 to 150	°C

## ST280CH..C Series

### ELECTRICAL SPECIFICATIONS

#### Voltage Ratings

Type number	Voltage Code	$V_{DRM}/V_{RRM}$ , max. repetitive peak and off-state voltage V	$V_{RSM}$ , maximum non-repetitive peak voltage V	$I_{DRM}/I_{RRM}$ max. @ $T_J = T_J$ max mA
ST280CH..C	04	400	500	75
	06	600	700	

#### On-state Conduction

Parameter	ST280CH..C	Units	Conditions	
$I_{T(AV)}$ Max. average on-state current @ Heatsink temperature	500 (185) 80 (110)	A °C	180° conduction, half sine wave double side (single side) cooled	
$I_{T(RMS)}$ Max. RMS on-state current	1130	A	DC @ 25°C heatsink temperature double side cooled	
$I_{TSM}$ Max. peak, one-cycle non-repetitive surge current	7200		t = 10ms	No voltage reappplied
	7500		t = 8.3ms	reappplied
	6000		t = 10ms	100% $V_{RRM}$
$I^2t$ Maximum $I^2t$ for fusing	6300	t = 8.3ms	reappplied	
	260	t = 10ms	No voltage reappplied	
		t = 8.3ms	reappplied	
	235	t = 10ms	100% $V_{RRM}$	
180	t = 8.3ms	reappplied		
165				
$I^2\sqrt{t}$ Maximum $I^2\sqrt{t}$ for fusing	2600	$KA^2\sqrt{s}$	t = 0.1 to 10ms, no voltage reappplied	
$V_{T(TO)1}$ Low level value of threshold voltage	0.84	V	$(16.7\% \times \pi \times I_{T(AV)} < I < \pi \times I_{T(AV)})$ , $T_J = T_J$ max.	
$V_{T(TO)2}$ High level value of threshold voltage	0.88		$(I > \pi \times I_{T(AV)})$ , $T_J = T_J$ max.	
$r_{t1}$ Low level value of on-state slope resistance	0.50	$m\Omega$	$(16.7\% \times \pi \times I_{T(AV)} < I < \pi \times I_{T(AV)})$ , $T_J = T_J$ max.	
$r_{t2}$ High level value of on-state slope resistance	0.47		$(I > \pi \times I_{T(AV)})$ , $T_J = T_J$ max.	
$V_{TM}$ Max. on-state voltage	1.35	V	$I_{pk} = 1000A$ , $T_J = T_J$ max, $t_p = 10ms$ sine pulse	
$I_H$ Maximum holding current	600	mA	$T_J = 25^\circ C$ , anode supply 12V resistive load	
$I_L$ Max (typical) latching current	1000 (300)			

#### Switching

Parameter	ST280CH..C	Units	Conditions
$di/dt$ Max. non-repetitive rate of rise of turned-on current	1000	A/ $\mu s$	Gate drive 20V, 20 $\Omega$ , $t_r \leq 1\mu s$ $T_J = T_J$ max, anode voltage $\leq 80\% V_{DRM}$
$t_d$ Typical delay time	1.0	$\mu s$	Gate current 1A, $di_g/dt = 1A/\mu s$ $V_d = 0.67\% V_{DRM}$ , $T_J = 25^\circ C$
$t_q$ Typical turn-off time	100		$I_{TM} = 300A$ , $T_J = T_J$ max, $di/dt = 20A/\mu s$ , $V_R = 50V$ $dv/dt = 20V/\mu s$ , Gate 0V 100 $\Omega$ , $t_p = 500\mu s$

ST280CH..C Series

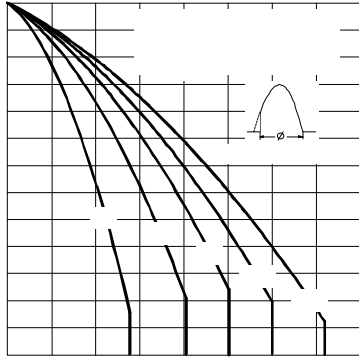

Fig. 3 - Current Ratings Characteristics

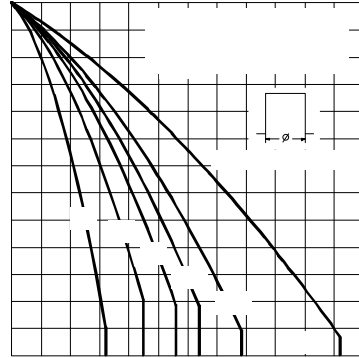

Fig. 4 - Current Ratings Characteristics

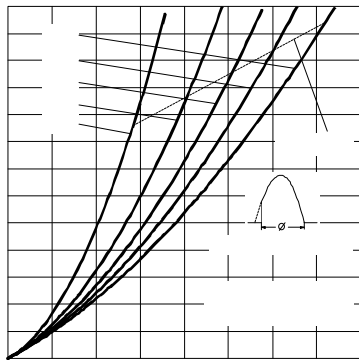

Fig. 5 - On-state Power Loss Characteristics

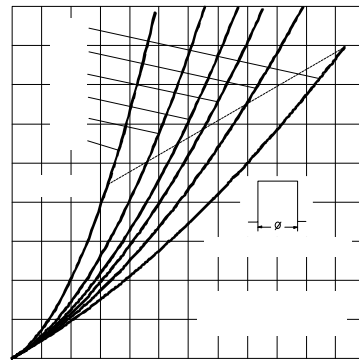

Fig. 6 - On-state Power Loss Characteristics

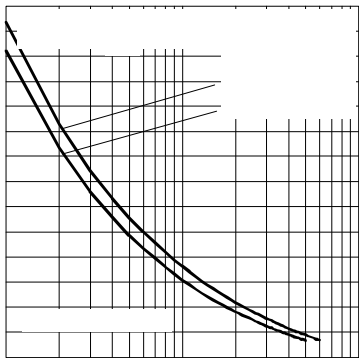

Fig. 7 - Maximum Non-Repetitive Surge Current  
Single and Double Side Cooled

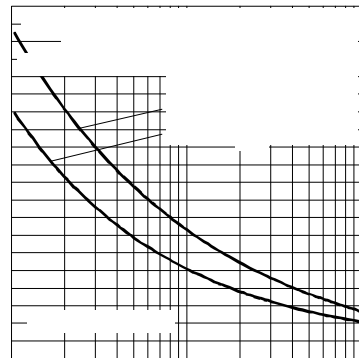

Fig. 8 - Maximum Non-Repetitive Surge Current  
Single and Double Side Cooled

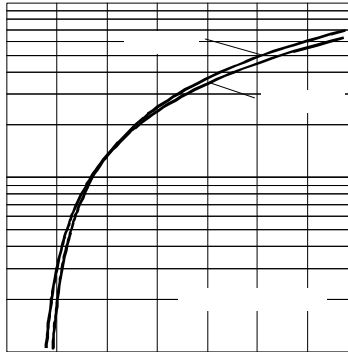

Fig. 9 - On-state Voltage Drop Characteristics

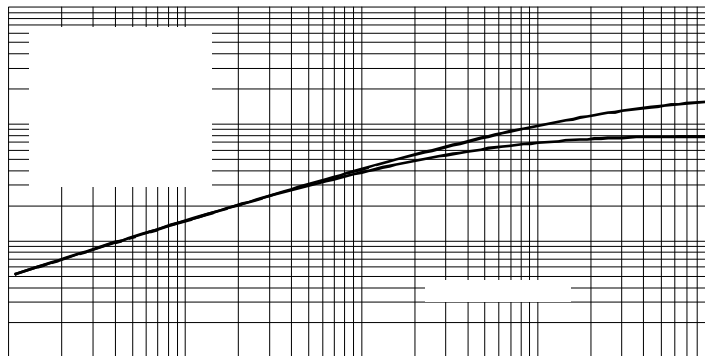

Fig. 10 - Thermal Impedance  $Z_{thJ-hs}$  Characteristics

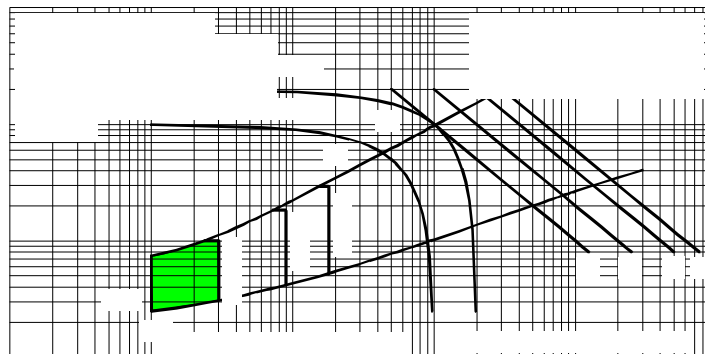

Fig. 11 - Gate Characteristics

Blocking

Parameter	ST280CH..C	Units	Conditions
dv/dt Maximum critical rate of rise of off-state voltage	500	V/ $\mu$ s	$T_J = T_J$ max. linear to 80% rated $V_{DRM}$
$I_{DRM}$ $I_{RRM}$ Max. peak reverse and off-state leakage current	75	mA	$T_J = T_J$ max, rated $V_{DRM}/V_{RRM}$ applied

Triggering

Parameter	ST280CH..C	Units	Conditions
$P_{GM}$ Maximum peak gate power	10.0	W	$T_J = T_J$ max, $t_p \leq 5$ ms
$P_{G(AV)}$ Maximum average gate power	2.0		$T_J = T_J$ max, $f = 50$ Hz, $d\% = 50$
$I_{GM}$ Max. peak positive gate current	3.0	A	$T_J = T_J$ max, $t_p \leq 5$ ms
$+V_{GM}$ Maximum peak positive gate voltage	20	V	$T_J = T_J$ max, $t_p \leq 5$ ms
$-V_{GM}$ Maximum peak negative gate voltage	5.0		
$I_{GT}$ DC gate current required to trigger	TYP.	MAX.	$T_J = -40^\circ\text{C}$ $T_J = 25^\circ\text{C}$ $T_J = 150^\circ\text{C}$  Max. required gate trigger/ current/ voltage are the lowest value which will trigger all units 12V anode-to-cathode applied
	180	-	
	90	150	
$V_{GT}$ DC gate voltage required to trigger	2.9	-	$T_J = -40^\circ\text{C}$ $T_J = 25^\circ\text{C}$ $T_J = 150^\circ\text{C}$
	1.8	3.0	
	1.0	-	
$I_{GD}$ DC gate current not to trigger	10	mA	$T_J = T_J$ max Max. gate current/voltage not to trigger is the max. value which will not trigger any unit with rated $V_{DRM}$ anode-to-cathode applied
$V_{GD}$ DC gate voltage not to trigger	0.30	V	

Thermal and Mechanical Specification

Parameter	ST280CH..C	Units	Conditions
$T_J$ Max. operating temperature range	-40 to 150	$^\circ\text{C}$	
$T_{stg}$ Max. storage temperature range	-40 to 150		
$R_{thJ-hs}$ Max. thermal resistance, junction to heatsink	0.17	K/W	DC operation single side cooled
	0.08		DC operation double side cooled
$R_{thC-hs}$ Max. thermal resistance, case to heatsink	0.033	K/W	DC operation single side cooled
	0.017		DC operation double side cooled
F Mounting force, $\pm 10\%$	4900	N	
	(500)	(Kg)	
wt Approximate weight	50	g	
Case style	TO - 200AB (A-PUK)		See Outline Table

## ST280CH..C Series

### $\Delta R_{thJ-hs}$ Conduction

(The following table shows the increment of thermal resistance  $R_{thJ-hs}$  when devices operate at different conduction angles than DC)

Conduction angle	Sinusoidal conduction		Rectangular conduction		Units	Conditions
	Single Side	Double Side	Single Side	Double Side		
180°	0.016	0.017	0.011	0.011	K/W	$T_J = T_{J \text{ max.}}$
120°	0.019	0.019	0.019	0.019		
90°	0.024	0.024	0.026	0.026		
60°	0.035	0.035	0.036	0.037		
30°	0.060	0.060	0.060	0.061		

### Ordering Information Table

Device Code							
ST	28	0	CH	06	C	1	
①	②	③	④	⑤	⑥	⑦	⑧
<b>1</b>	- Thyristor	<b>2</b>	- Essential part number	<b>3</b>	- 0 = Converter grade	<b>4</b>	- CH = Ceramic Puk, High temperature
<b>5</b>	- Voltage code: Code x 100 = $V_{RRM}$ (See Voltage Rating Table)	<b>6</b>	- C = Puk Case TO-200AB (A-PUK)	<b>7</b>	- 0 = Eyelet terminals (Gate and Auxiliary Cathode Unsoldered Leads)	1 = Fast-on terminals (Gate and Auxiliary Cathode Unsoldered Leads)	2 = Eyelet terminals (Gate and Auxiliary Cathode Soldered Leads)
<b>7</b>	- 1 = Fast-on terminals (Gate and Auxiliary Cathode Unsoldered Leads)	<b>8</b>	- Critical dv/dt: None = 500V/ $\mu$ sec (Standard selection)	L	= 1000V/ $\mu$ sec (Special selection)	3 = Fast-on terminals (Gate and Auxiliary Cathode Soldered Leads)	

Outline Table

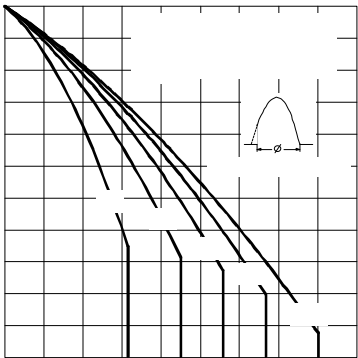
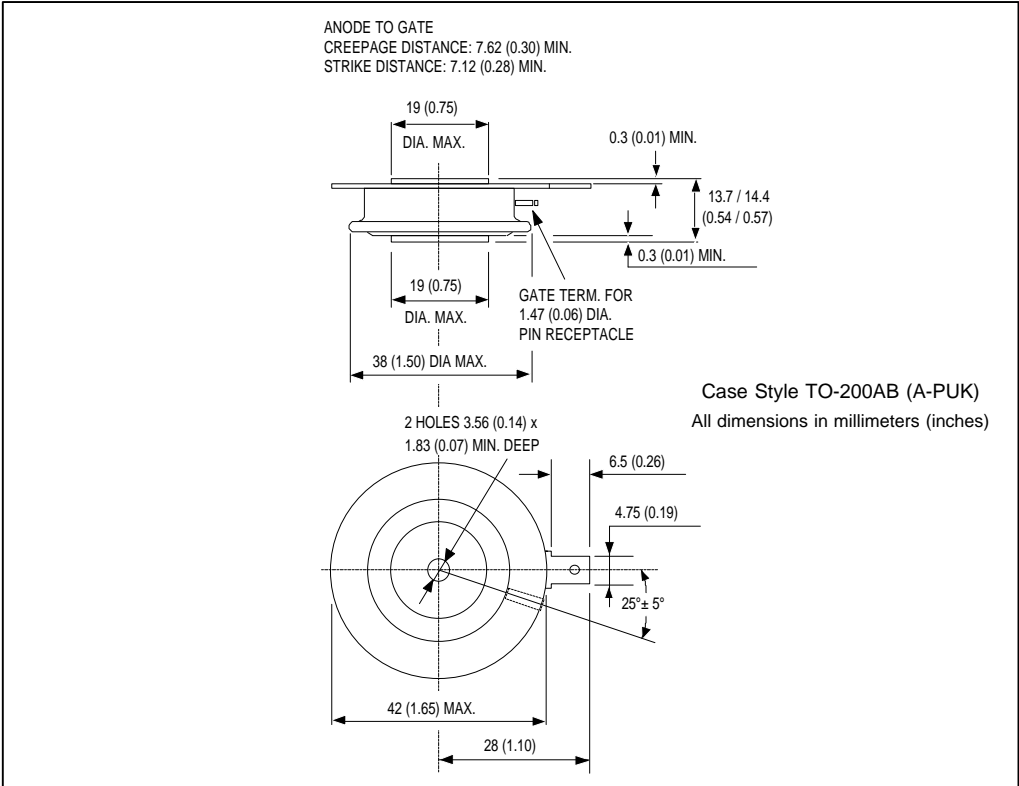

Fig. 1 - Current Ratings Characteristics

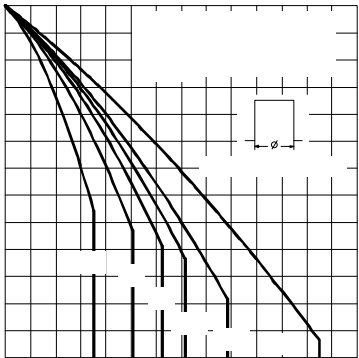

Fig. 2 - Current Ratings Characteristics