



DISCRETE POWER DIODES and THYRISTORS
DATA BOOK

INVERTER GRADE THYRISTORS
Stud Version
Features

- All diffused design
- Center amplifying gate
- Guaranteed high dv/dt
- Guaranteed high di/dt
- High surge current capability
- Low thermal impedance
- High speed performance

330A
Typical Applications

- Inverters
- Choppers
- Induction heating
- All types of force-commutated converters

Major Ratings and Characteristics

Parameters	ST333S	Units
$I_{T(AV)}$	330	A
	@ T_C	75 °C
$I_{T(RMS)}$	518	A
I_{TSM}	@ 50Hz	11000 A
	@ 60Hz	11520 A
I^2t	@ 50Hz	605 KA ² s
	@ 60Hz	550 KA ² s
V_{DRM}/V_{RRM}	400 to 800	V
t_q range	10 to 30	µs
T_J	- 40 to 125	°C

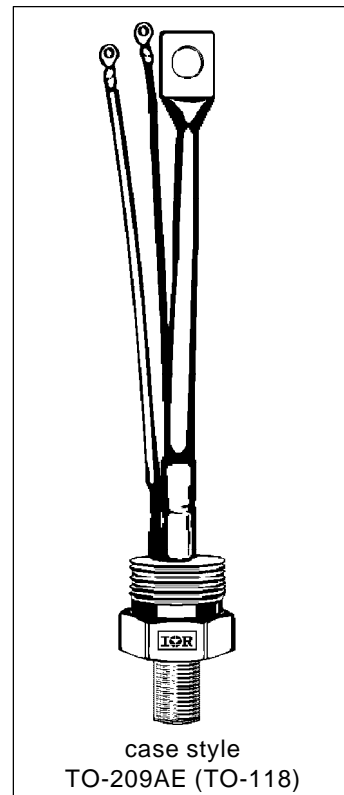

ST333S Series

ELECTRICAL SPECIFICATIONS

Voltage Ratings

Type number	Voltage Code	V_{DRM}/V_{RRM} , maximum repetitive peak voltage V	V_{RSM} , maximum non-repetitive peak voltage V	I_{DRM}/I_{RRM} max. @ $T_J = T_J$ max. mA
ST333S	04	400	500	50
	08	800	900	

Current Carrying Capability

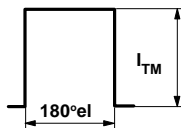
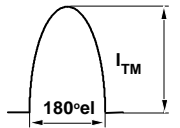
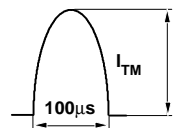
Frequency							Units
50Hz	840	600	1280	1040	5430	4350	A
400Hz	650	450	1280	910	2150	1560	
1000Hz	430	230	1090	730	1080	720	
2500Hz	140	60	490	250	400	190	
Recovery voltage Vr	50	50	50	50	50	50	V
Voltage before turn-on Vd	V_{DRM}		V_{DRM}		V_{DRM}		
Rise of on-state current di/dt	50	50	-	-	-	-	A/µs
Case temperature	50	75	50	75	50	75	°C
Equivalent values for RC circuit	10Ω / 0.47µF		10Ω / 0.47µF		10Ω / 0.47µF		

On-state Conduction

Parameter	ST333S	Units	Conditions	
$I_{T(AV)}$ Max. average on-state current @ Case temperature	330	A	180° conduction, half sine wave	
	75	°C		
$I_{T(RMS)}$ Max. RMS on-state current	518	A	DC @ 63°C case temperature	
I_{TSM} Max. peak, one half cycle, non-repetitive surge current	11000		t = 10ms	No voltage reappplied
	11520		t = 8.3ms	100% V_{RRM} reappplied
	9250		t = 10ms	Sinusoidal half wave, Initial $T_J = T_J$ max
9700	t = 8.3ms			
I^2t Maximum I^2t for fusing	605	KA ² s	t = 10ms	
	550		t = 8.3ms	
	430		t = 10ms	
	390		t = 8.3ms	
$I^2\sqrt{t}$ Maximum $I^2\sqrt{t}$ for fusing	6050	KA ² /s	t = 0.1 to 10ms, no voltage reappplied	

ST333S Series

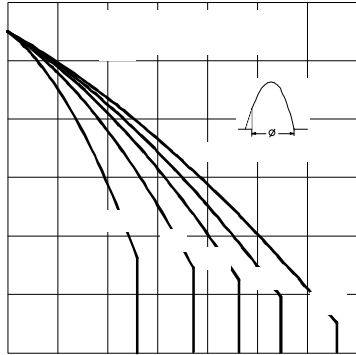

Fig. 1 - Current Ratings Characteristics

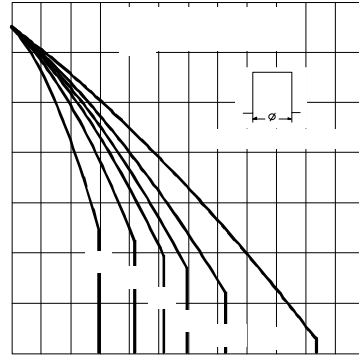

Fig. 2 - Current Ratings Characteristics

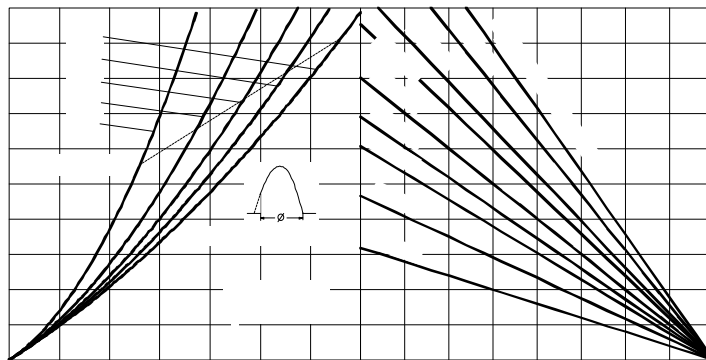

Fig. 3 - On-state Power Loss Characteristics

www.DataSheet4U.com

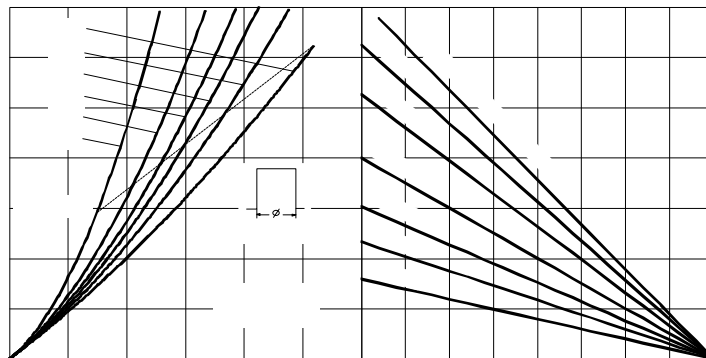

Fig. 4 - On-state Power Loss Characteristics

ST333S Series

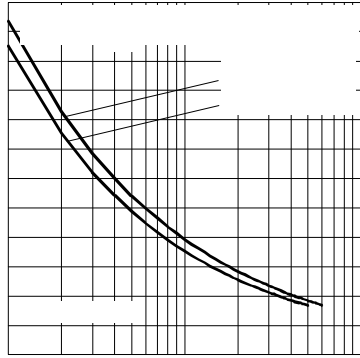

Fig. 5 - Maximum Non-repetitive Surge Current

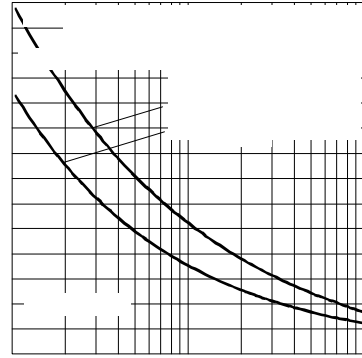

Fig. 6 - Maximum Non-repetitive Surge Current

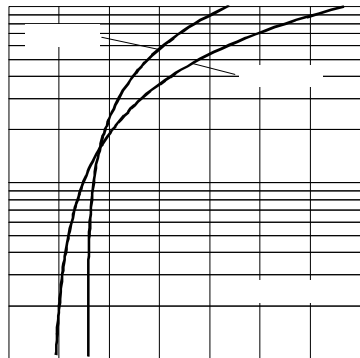

Fig. 7 - On-state Voltage Drop Characteristics

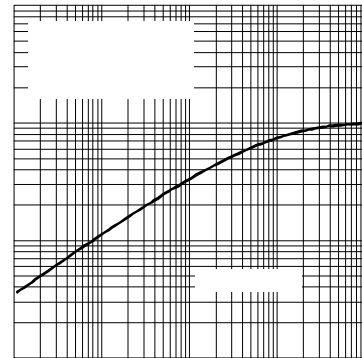

Fig. 8 - Thermal Impedance Z_{thJC} Characteristic

www.DataSheet4U.com

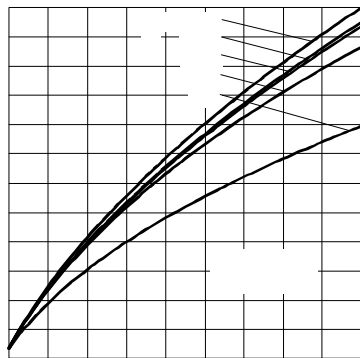

Fig. 9 - Reverse Recovered Charge Characteristics

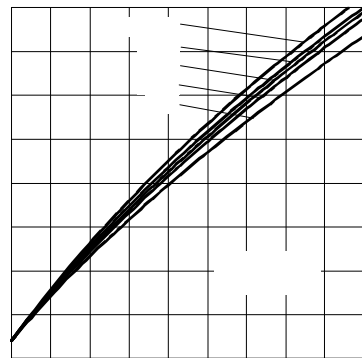

Fig. 10 - Reverse Recovery Current Characteristics

ST333S Series

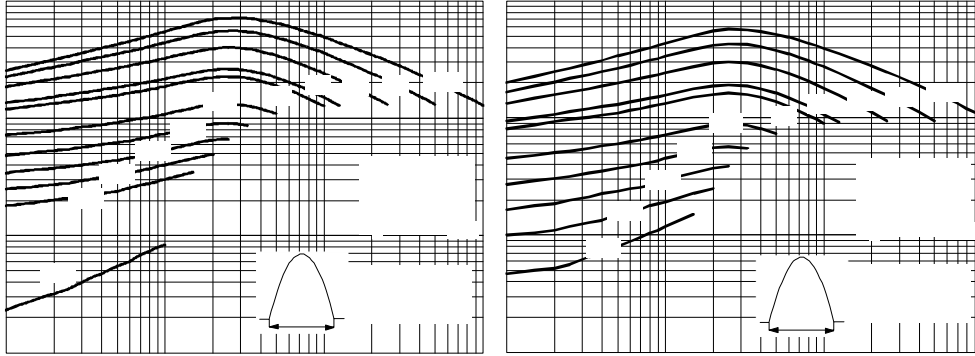
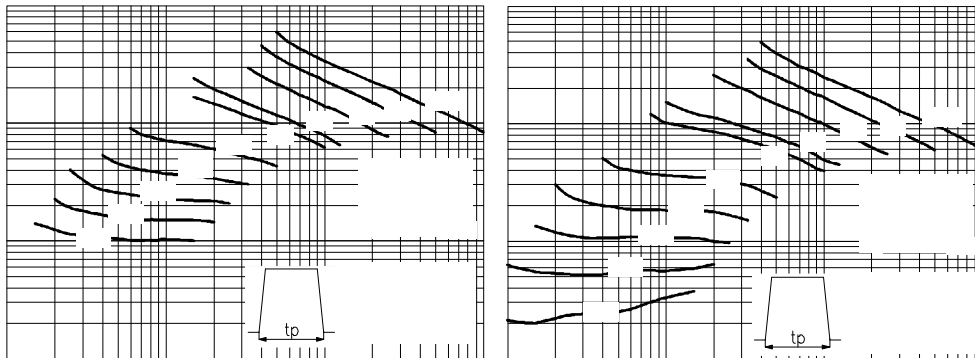

Fig. 11 - Frequency Characteristics



www.DataSheet4U.com

Fig. 12 - Frequency Characteristics

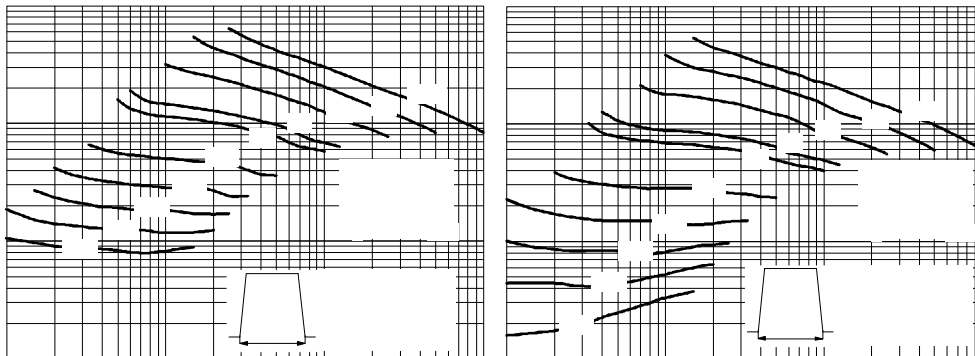

Fig. 13 - Frequency Characteristics

ST333S Series

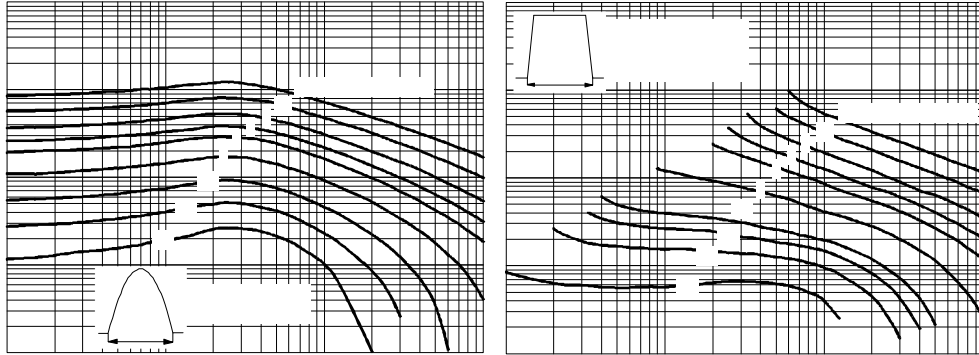

Fig. 14 - Maximum On-state Energy Power Loss Characteristics

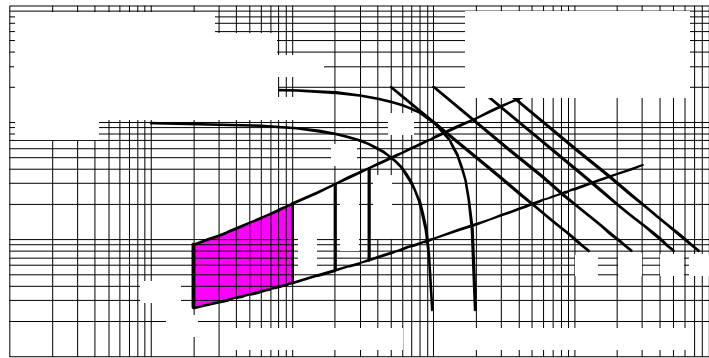

Fig. 15 - Gate Characteristics

ST333S Series

On-state Conduction

Parameter	ST333S	Units	Conditions
V_{TM} Max. peak on-state voltage	1.51	V	$I_{TM} = 1040A$, $T_J = T_J \text{ max}$, $t_p = 10\text{ms}$ sine wave pulse
$V_{T(TO)1}$ Low level value of threshold voltage	0.91		$(16.7\% \times \pi \times I_{T(AV)} < I < \pi \times I_{T(AV)})$, $T_J = T_J \text{ max}$.
$V_{T(TO)2}$ High level value of threshold voltage	0.92		$(I > \pi \times I_{T(AV)})$, $T_J = T_J \text{ max}$.
r_{t1} Low level value of forward slope resistance	0.58	m Ω	$(16.7\% \times \pi \times I_{T(AV)} < I < \pi \times I_{T(AV)})$, $T_J = T_J \text{ max}$.
r_{t2} High level value of forward slope resistance	0.58		$(I > \pi \times I_{T(AV)})$, $T_J = T_J \text{ max}$.
I_H Maximum holding current	600	mA	$T_J = 25^\circ\text{C}$, $I_T > 30A$
I_L Typical latching current	1000		$T_J = 25^\circ\text{C}$, $V_A = 12V$, $R_a = 6\Omega$, $I_G = 1A$

Switching

Parameter	ST333S	Units	Conditions
di/dt Max. non-repetitive rate of rise of turned-on current	1000	A/ μs	$T_J = T_J \text{ max}$, $V_{DRM} = \text{rated } V_{DRM}$ $I_{TM} = 2 \times \text{di/dt}$
t_d Typical delay time	1.0	μs	$T_J = 25^\circ\text{C}$, $V_{DM} = \text{rated } V_{DRM}$, $I_{TM} = 50A \text{ DC}$, $t_p = 1\mu\text{s}$ Resistive load, Gate pulse: 10V, 5 Ω source
t_q Max. turn-off time	Min 10 Max 30		$T_J = T_J \text{ max}$, $I_{TM} = 550A$, commutating di/dt = 40A/ μs $V_R = 50V$, $t_p = 500\mu\text{s}$, dv/dt: see table in device code

Blocking

Parameter	ST333S	Units	Conditions
dv/dt Maximum critical rate of rise of off-state voltage	500	V/ μs	$T_J = T_J \text{ max}$. linear to 80% V_{DRM} , higher value available on request
I_{RRM} I_{DRM} Max. peak reverse and off-state leakage current	50	mA	$T_J = T_J \text{ max}$, rated V_{DRM}/V_{RRM} applied

Triggering

Parameter	ST333S	Units	Conditions
P_{GM} Maximum peak gate power	60	W	$T_J = T_J \text{ max}$, $f = 50\text{Hz}$, $d\% = 50$
$P_{G(AV)}$ Maximum average gate power	10		
I_{GM} Max. peak positive gate current	10	A	$T_J = T_J \text{ max}$, $t_p \leq 5\text{ms}$
$+V_{GM}$ Maximum peak positive gate voltage	20	V	$T_J = T_J \text{ max}$, $t_p \leq 5\text{ms}$
$-V_{GM}$ Maximum peak negative gate voltage	5		
I_{GT} Max. DC gate current required to trigger	200	mA	$T_J = 25^\circ\text{C}$, $V_A = 12V$, $R_a = 6\Omega$
V_{GT} Max. DC gate voltage required to trigger	3	V	
I_{GD} Max. DC gate current not to trigger	20	mA	$T_J = T_J \text{ max}$, rated V_{DRM} applied
V_{GD} Max. DC gate voltage not to trigger	0.25	V	

ST333S Series

Thermal and Mechanical Specifications

Parameter	ST333S	Units	Conditions
T _J Max. junction operating temperature range	-40 to 125	°C	
T _{stg} Max. storage temperature range	-40 to 150		
R _{thJC} Max. thermal resistance, junction to case	0.10	K/W	DC operation
R _{thCS} Max. thermal resistance, case to heatsink	0.03		Mounting surface, smooth, flat and greased
T Mounting torque, ± 10%	48.5 (425)	Nm (lbf-in)	Non lubricated threads
wt Approximate weight	535	g	
Case style	TO-209AE (TO-118)		See Outline Table

ΔR_{thJC} Conduction

(The following table shows the increment of thermal resistance R_{thJC} when devices operate at different conduction angles than DC)

Conduction angle	Sinusoidal conduction	Rectangular conduction	Units	Conditions
180°	0.011	0.008	K/W	T _J = T _J max.
120°	0.013	0.014		
90°	0.017	0.018		
60°	0.025	0.026		
30°	0.041	0.042		

Ordering Information Table

Device Code

ST	33	3	S	08	P	F	M	0	
①	②	③	④	⑤	⑥	⑦	⑧	⑨	⑩

- 1** - Thyristor
- 2** - Essential part number
- 3** - 3 = Fast turn off
- 4** - S = Compression bonding Stud
- 5** - Voltage code: Code x 100 = V_{RRM} (See Voltage Ratings table)
- 6** - P = Stud base 3/4" 16UNF-2A
M = Stud base metric threads M24 x 1.5
- 7** - Reapplied dv/dt code (for t_q test condition)
- 8** - t_q code
- 9** - 0 = Eyelet terminals (Gate and Aux. Cathode Leads)
1 = Fast-on terminals (Gate and Aux. Cathode Leads)
3 = Threaded top terminal 3/8" 24UNF-2A
- 10** - Critical dv/dt:
None = 500V/μsec (Standard value)
L = 1000V/μsec (Special selection)

dv/dt - t _q combinations available					
dv/dt (V/μs)	20	50	100	200	400
10	CN	DN	EN	--	--
12	CM	DM	EM	FM *	--
15	CL	DL	EL	FL *	HL
18	CP	DP	EP	FP	HP
20	CK	DK	EK	FK	HK
25	--	--	--	FJ	HJ
30	--	--	--	--	HH

*Standard part number.
All other types available only on request.

ST333S Series

Outline Table

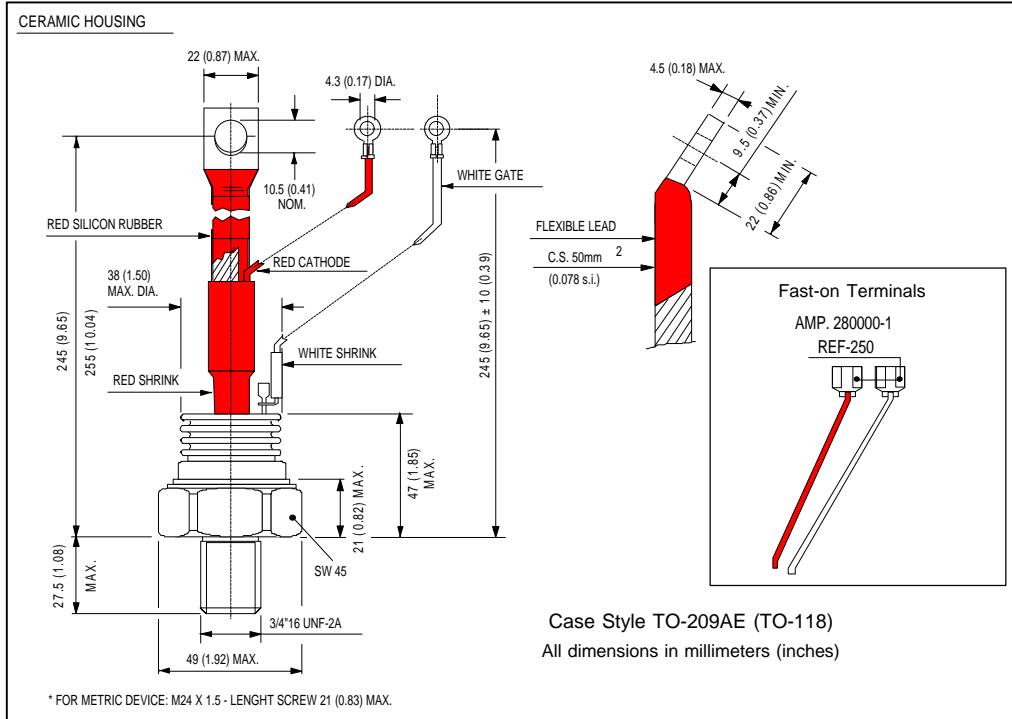

www.DataSheet4U.com

