

Silicon Dual Power Rectifier ST6020 — ST60100

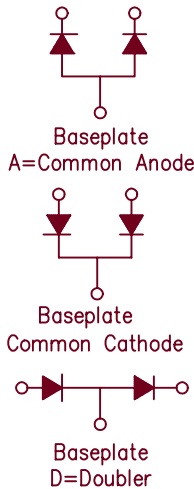
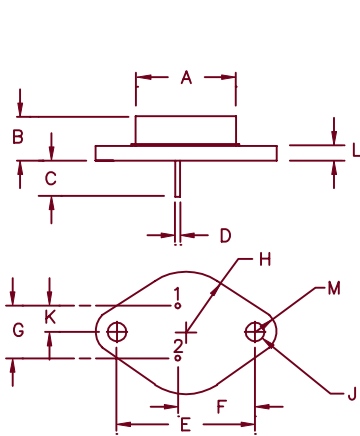

Dim.	Inches		Millimeter		Notes
	Minimum	Maximum	Minimum	Maximum	
A	—	.875	—	22.23	Dia.
B	.250	.450	6.35	11.43	
C	.312	—	7.92	—	
D	.057	.063	1.45	1.60	Dia.
E	1.177	1.197	29.90	30.40	
F	.655	.675	16.64	17.15	
G	.420	.440	10.67	11.18	
H	—	.525	—	13.34	Rad.
J	.151	.161	3.84	4.09	Dia.
K	.205	.225	5.21	5.72	
L	—	.135	—	3.43	
M	—	.188	—	4.78	Rad.

TO-3

Microsemi Catalog Number	Peak Reverse Voltage
ST6020*	200V
ST6040*	400V
ST6060*	600V
ST6080*	800V
ST60100*	1000V

*Add D, or A

Standard processing is common cathode with no suffix added.

- Glass passivated die
- Glass to metal seal construction
- VRRM 200 to 1000V
- 400A Surge Rating
- Available as common anode, common cathode, or doubler

Electrical Characteristics Per Leg

Average forward current per leg (standard)	IF(AV) 20 Amps	TC = 150°C, half sine wave, RθJC = 1.2°C/W
Average forward current per leg (reverse)	IF(AV) 20 Amps	TC = 146°C, half sine wave, RθJC = 1.4°C/W
Maximum surge current	IFSM 400 Amps	8.3ms, half sine, TJ = 175°C
Max I ² t for fusing	I ² t 665 A ² s	
Max peak forward voltage	VFM 1.1 Volts	IFM = 30A; TJ = 25°C
Max peak reverse current	IRM 10 μA	VRRM, TJ = 25°C
Max peak reverse current	IRM 1.0 mA	VRRM, TJ = 150°C
Max recommended operating frequency	10kHz	

*Pulse test: Pulse width 300 μsec. Duty cycle 2%

Thermal and Mechanical Characteristics

Storage temperature range	TSTG	-65°C to 200°C
Operating junction temp range	TJ	-65°C to 175°C
Maximum thermal resistance (standard polarity)	RθJC	1.2°C/W Junction to case
Maximum thermal resistance (reverse polarity)	RθJC	1.4°C/W Junction to case
Typical thermal resistance (greased)	RθCS	0.5°C/W Case to sink
Weight		1.0 ounces (28 grams) typical

12-7-00 Rev. 1

ST6020 – ST60100

Figure 1
Typical Forward Characteristics – Per Leg

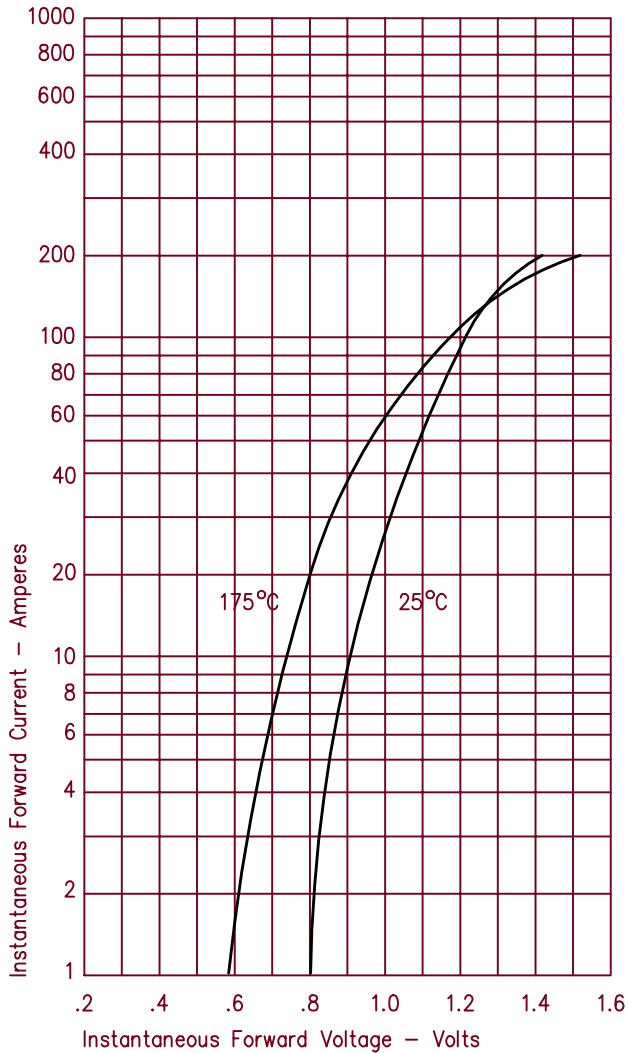

Figure 2
Typical Reverse Characteristics – Per Leg

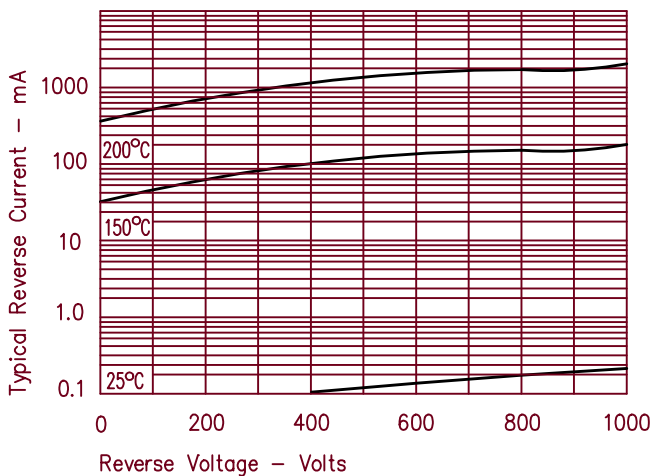

Figure 3
Forward Current Derating – Per Leg – Standard Polarity

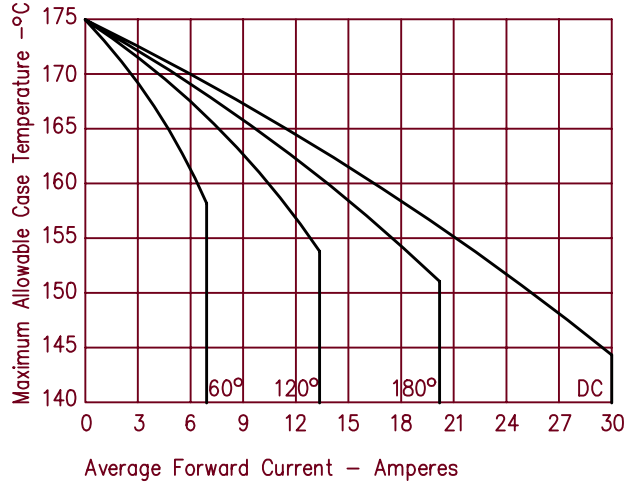

Figure 4
Maximum Forward Power Dissipation – Per Leg – Standard Polarity

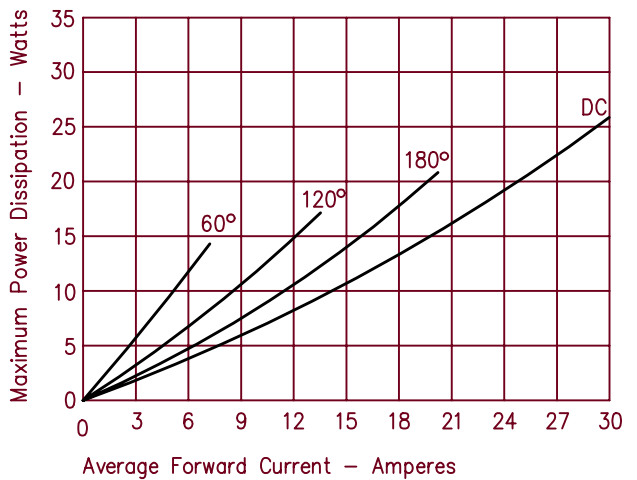
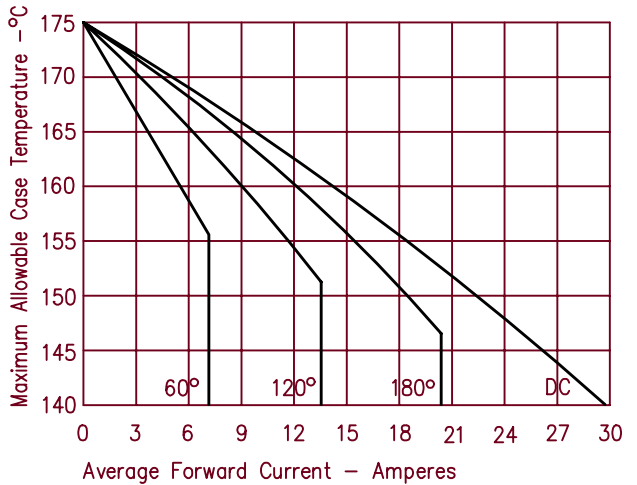

Figure 5
Forward Current Derating – Per Leg – Reverse Polarity



ST6020 — ST60100

Figure 6
Maximum Forward Power Dissipation – Per Leg – Reverse Polarity

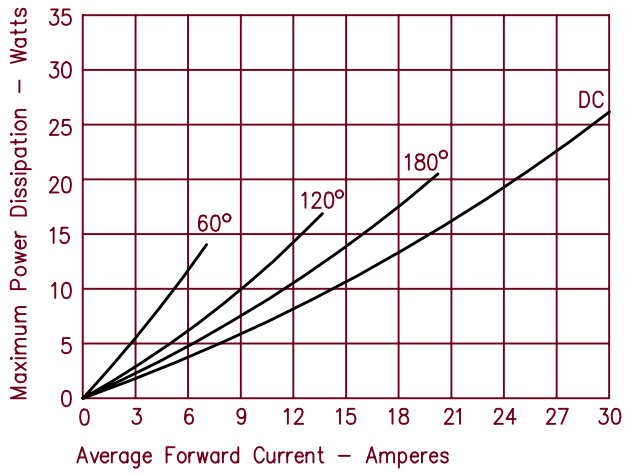

Figure 8
Transient Thermal Impedance – Reverse Polarity

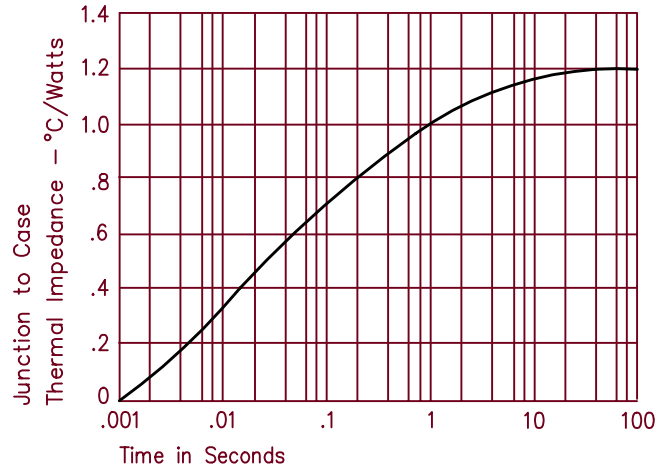

Figure 7
Transient Thermal Impedance – Per Leg – Standard Polarity

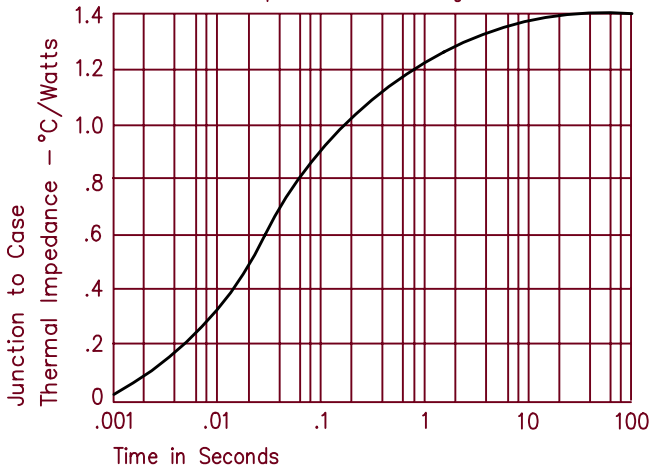

Figure 9
Maximum Nonrepetitive Surge Current

