



# ST7775R

---

**176RGB x 220 dot 262K Color with Frame Memory  
Single-Chip TFT Controller/Driver**

---

## **Datasheet**

**Preliminary Version 0.1  
2010/03**

**Sitronix Technology Corporation**

Sitronix Technology Corp. reserves the right to change the contents in this document without prior notice.

**LIST OF CONTENT**

<b>1</b>	<b>GENERAL DESCRIPTION .....</b>	<b>8</b>
<b>2</b>	<b>FEATURES .....</b>	<b>9</b>
<b>3</b>	<b>PAD ARRANGEMENT .....</b>	<b>11</b>
	3.1.. Pad Arrangement.....	11
	3.2.. Bump Dimension .....	12
	3.3.. Alignment Mark Dimension .....	13
	3.4.. Chip Information .....	13
<b>4</b>	<b>PAD CENTER COORDINATES .....</b>	<b>14</b>
<b>5</b>	<b>BLOCK DIAGRAM .....</b>	<b>29</b>
<b>6</b>	<b>PIN DESCRIPTION .....</b>	<b>30</b>
	6.1.. Power Supply Pins.....	30
	6.2.. Interface Logic Pins .....	31
	6.3.. Driver Output Pins .....	33
	6.4.. Test Pins.....	34
<b>7</b>	<b>DRIVER ELECTRICAL CHARACTERISTICS.....</b>	<b>35</b>
	7.1.. Absolute Operation Range .....	35
	7.2.. DC Characteristics.....	36
	7.3.. Power Consumption .....	37
	7.4.. AC Characteristics .....	38
	7.4.1 8080 Series MCU Parallel Interface Characteristics: 18/16/9/8-bit Bus .....	38
	7.4.2 6800 Series MCU Parallel Interface Characteristics: 18/16/9/8-bit Bus .....	40
	7.4.3 Serial Data Transfer Interface Characteristics: .....	41
	7.4.4 RGB Interface Characteristics: .....	42
<b>8</b>	<b>INTERFACE .....</b>	<b>44</b>
	8.1.. MCU Interface Type Selection.....	44
	8.2.. 8080-Series MCU Write Cycle Sequence.....	45
	8.3.. 6800-Series MCU Write Cycle Sequence.....	46
	8.3.1 18 bits Interface Write Data Format.....	47
	8.3.2 16 bits Interface Write Data Format.....	48
	8.3.3 9 bits Interface Write Data Format.....	49
	8.3.4 8 bits Interface Write Data Format.....	51
	8.3.5 8080-series MCU Read Cycle Sequence.....	53
	8.3.6 6800-series MCU Read Cycle Sequence.....	54
	8.3.7 18bits interface read data format.....	55
	8.3.8 16bits Interface Read Data Format .....	56
	8.3.9 9bits Interface Read Data Format .....	57
	8.3.10 8bits Interface Read Data Format .....	58

8.4..	RGB Input Interface .....	60
8.4.1	RGB Interface .....	61
8.4.2	RGB Interface Timing.....	62
8.4.3	Moving Picture Mode .....	64
8.4.4	6-bit RGB Interface.....	66
8.4.5	16-bit RGB Interface.....	67
8.4.6	18-bit RGB Interface.....	68
8.5..	Interface Timing .....	71
8.6..	24-bit Serial Peripheral Interface (24-bit SPI) .....	72
8.7..	9-bit Serial Peripheral Interface (9-bit SPI) .....	76
8.8..	8-bit Serial Peripheral Interface (8-bit SPI) .....	78
8.9..	Data Transfer Recovery.....	80
8.10..	Register Descriptions.....	80
<b>9</b>	<b>COMMAND.....</b>	<b>84</b>
9.1..	System Function Command List.....	84
9.2..	System Function Command.....	86
9.2.1	Index (IR) .....	86
9.2.2	Device ID Code Read (R00h).....	86
9.2.3	Device Output Control (R01h).....	86
9.2.4	LCD Driving Wave Control (R02h).....	88
9.2.5	Entry Mode (R03h).....	89
9.2.6	Display Control 1 (R07h).....	92
9.2.7	Display Control 2 (R08h).....	94
9.2.8	Frame Cycle Control (R0Bh).....	95
9.2.9	RGB Display Interface Control 1 (R0Ch).....	96
9.2.10	Oscillator Control (R0Fh).....	97
9.2.11	Power Control 1 (R10h).....	97
9.2.12	Power Control 2 (R11h).....	98
9.2.13	DRAM Horizontal/Vertical Address Set (R20h, R21h).....	98
9.2.14	Write Data to DRAM (R22h) .....	99
9.2.15	Read Data from DRAM (R22h).....	100
9.2.16	Softwave Reset (R28h).....	101
9.2.17	Gate Scan Control (R30h).....	102
9.2.18	Vertical Scroll Control1 (R31h,R32h) .....	103
9.2.19	Vertical Scroll Control1 (R33h) .....	104
9.2.20	Partial Screen Driving Position (R34h,R35h).....	105
9.2.21	Horizontal and Vertical RAM Address Position (R36h, R37h, R38h, R39h) .....	105
9.2.22	Gamma Control (R50h~R59h) .....	106

9.2.23	ID Code(R65h, Read Only).....	108
9.2.24	SPI Read/Write Control(R66h).....	108
9.2.25	Power Control 2 (RB0h).....	109
9.2.26	Power Control 3 (RB1h).....	111
9.2.27	Power Control 4 (RB2h).....	112
9.2.28	Power Control 5 (RB3h).....	錯誤! 尚未定義書籤。
9.2.29	Power Control 6 (RB5h).....	錯誤! 尚未定義書籤。
9.2.30	NVM ID Code (RD2h).....	113
9.2.31	NVM Control Status (RD9h).....	113
9.2.32	NVM Write Command (RDFh).....	114
9.2.33	NVM Enable (RFAh).....	115
9.2.34	NVM VCOM Offset (RFEh).....	115
9.2.35	NVM Command Enable (RFFh).....	115
<b>10</b>	<b>RESET FUNCTION .....</b>	<b>116</b>
10.1..	System Function Command List.....	116
10.2..	RAM Data Initialization .....	116
10.3..	Note on Reset Function.....	116
10.4..	Reset Timing Characteristic.....	116
<b>11</b>	<b>8 - COLOR DISPLAY MODE.....</b>	<b>118</b>
<b>12</b>	<b>WINDOW ADDRESS FUNCTION .....</b>	<b>119</b>
<b>13</b>	<b>GAMMA CORRECTION.....</b>	<b>120</b>
<b>14</b>	<b>APPLICATION .....</b>	<b>123</b>
14.1..	Configuration of Power Supply Circuit.....	123
14.2..	Standby Mode.....	124
14.3..	Power Supply Configuration.....	125
14.4..	Voltage Generation.....	126
14.5..	Applied Voltage to the TFT panel .....	127
<b>15</b>	<b>REVISION HISTORY .....</b>	<b>128</b>

**LIST OF FIGURES**

Figure 1 Parallel Interface Timing Characteristics (8080-Series MCU Interface) ..... 38

Figure 2 Rising and Falling Timing for I/O Signal ..... 39

Figure 3 Write-to-Read and Read-to-Write Timing ..... 39

Figure 4 Parallel Interface Timing Characteristics (6800-Series MCU Interface) ..... 40

Figure 5 SPI Interface Timing Characteristics ..... 41

Figure 6 RGB Interface Timing Characteristics ..... 42

Figure 7 8080-Series WRX Protocol ..... 45

Figure 8 8080-Series Parallel Bus Protocol, Write to Register or Display RAM ..... 45

Figure 9 6800-Series WRX Protocol ..... 46

Figure 10 6800-Series Parallel Bus Protocol, Write to Register or Display RAM ..... 46

Figure 11 18 bits Interface Data Format (Command Write/DRAM Write) ..... 47

Figure 12 16 bits Interface Data Format (Command Write/Display RAM Write) ..... 49

Figure 13 9 bits Interface Data Format (Command Write/Display RAM Write) ..... 50

Figure 14 8 bits interface data format (command write/Display RAM write) ..... 52

Figure 15 8080-Series Read Protocol ..... 53

Figure 16 8080-series parallel bus protocol, read data from register or display RAM ..... 53

Figure 17 6800-Series Read Protocol ..... 54

Figure 18 6800-series parallel bus protocol, read data from register or display RAM ..... 54

Figure 19 18 bits Interface Data Format (Command Read/Display RAM Read) ..... 55

Figure 20 16 bits Interface Data Format (Command Read/Display RAM Read) ..... 56

Figure 21 9 bits Interface Data Format (Command Read/Display RAM Read) ..... 57

Figure 22 8 bits Interface Data Format (Command Read/Display RAM Read) ..... 58

Figure 23 DRAM Address Map Table ..... 59

Figure 24 RGB Interface Data Format ..... 60

Figure 25 DRAM Access Area by RGB Interface ..... 61

Figure 26 Timing Chart of Signals in 18-/16-bit RGB Interface Mode ..... 62

Figure 27 Timing chart of signals in 6-bit RGB interface mode ..... 63

Figure 28 Example of update the still and moving picture ..... 65

Figure 29 Example of 6-bit RGB interface data format ..... 66

Figure 30 6-bit Transfer Synchronization ..... 66

Figure 31 Example of 16-Bit RGB Interface and Data Format ..... 67

Figure 32 Example of 18-bit RGB Interface and Data Format ..... 68

Figure 33 Internal clock operation/RGB interface mode switching ..... 69

Figure 34 DRAM access between system interface and RGB interface ..... 70

Figure 35 Relationship between RGB I/F signals and LCD Driving Signals for Pane ..... 71

Figure 36 Data Format of SPI Interface ..... 73

Figure 37 Data transmission through serial peripheral interface (SPI) ..... 74

Figure 38 Data transmission through serial peripheral interface (SPI, TRI="1" and DFM="1 or 0") .....	75
Figure 39 9-bit SPI Write Register Mode .....	76
Figure 40 9-bit SPI Read Register mode .....	77
Figure 41 9-bit SPI 65K colors Serial Data Transfer, .....	77
Figure 42 9-bit SPI 262K colors Serial Data Transfer .....	78
Figure 43 8-bit SPI Write Register Mode .....	78
Figure 44 8-bit SPI Read Register mode .....	79
Figure 45 8-bit SPI 65K colors Serial Data Transfer, .....	79
Figure 46 8-bit SPI 262K colors Serial Data Transfer .....	79
Figure 47 Data Transfer Recovery .....	80
Figure 48 Register Setting with Serial Peripheral Interface (SPI) .....	81
Figure 49 Register setting with i80 System Interface .....	82
Figure 50 Register Read/Write Timing of i80 System Interface .....	83
Figure 51 Reset Timing .....	116
Figure 52 8-Color Display Mode .....	118
Figure 53 DRAM Access Window Map .....	119
Figure 54 Grayscale Voltage Generation (Positive) .....	120
Figure 55 Grayscale Voltage Generation (Negative) .....	121
Figure 56 Relationship between Source Output and VCOM .....	122
Figure 57 Relationship between DRAM Data and Output Level .....	122
Figure 58 Power Supply Circuit Block .....	123
Figure 59 Standby Mode Register Setting Sequence .....	124
Figure 60 Power Supply ON/OFF Sequence .....	125
Figure 61 Power Booster Level .....	126
Figure 62 Voltage Output to TFT LCD Panel .....	127

---

**LIST OF TABLES**

Table 1 Absolute Operation Range .....	35
Table 2 Basic DC Characteristics .....	36
Table 3 Power Consumption .....	37
Table 4 8080 Parallel Interface Characteristics.....	39
Table 5 8080 Parallel Interface Characteristics.....	40
Table 6 SPI Interface Characteristics .....	41
Table 7 18/16 Bits RGB Interface Timing Characteristics .....	42
Table 8 6 Bits RGB Interface Timing Characteristics .....	43
Table 9 Interface Type Selection .....	44
Table 10 System Function Command List.....	85
Table 11 Reset timing Characteristics.....	117
Table 12 Outside Components .....	123

Preliminary

## 1 GENERAL DESCRIPTION

The ST7775R is a single-chip controller/driver for 262K-color, graphic type TFT-LCD. It consists of 528 source line and 220 gate line driving circuits. This chip is capable of connecting directly to an external microprocessor, and accepts, 8-bits/9-bits/16-bits/18-bits parallel interface. Display data can be stored in the on-chip display data RAM of 176x220x18 bits. It can perform display data RAM read/write operation with no external operation clock to minimize power consumption. In addition, because of the integrated power supply circuit necessary to drive liquid crystal; it is possible to make a display system with the fewest components.

Preliminary



## 2 FEATURES

- Single chip TFT-LCD Controller/Driver with On-chip Frame Memory (FM)
- Display Resolution: 176\*RGB (H) \*220(V)
- Frame Memory Size: 176 x 220 x 18-bit = 696,960 bits
- LCD Driver Output Circuits
  - Source Outputs: 176 RGB Channels
  - Gate Outputs: 220 Channels
  - Common Electrode Output
- Display Colors (Color Mode)
  - Full Color: 262K, RGB=(666) max., Idle Mode Off
  - Color Reduce: 8-color, RGB=(111), Idle Mode On
- Programmable Pixel Color Format (Color Depth) for Various Display Data input Format
  - 12-bit/pixel: RGB=(444) using the 696,960 bits frame memory
  - 16-bit/pixel: RGB=(565) using the 696,960 bits frame memory
  - 18-bit/pixel: RGB=(666) using the 696,960 bits frame memory
- MCU Interface
  - Parallel 8080-series MCU Interface (8-bit, 9-bit, 16-bit & 18-bit)
  - Parallel 6800-series MCU Interface (8-bit, 9-bit, 16-bit & 18-bit)
  - 6/16/18 RGB Interface(VSYNC, HSYNC, DOTCLK, ENABLE, DB[17:0])
  - Serial Peripheral Interface(SPI Interface)
  - VSYNC Interface
- Display Features
  - Programmable Partial Display Duty
- **Support LC Type**
  - Support both normal-black & normal-white LC
- On Chip Build-In Circuits
  - DC/DC Converter
  - Adjustable VCOM Generation
  - Non-Volatile (NV) Memory to Store Initial Register Setting and Factory Default Value (Module ID, Module Version, etc)
  - Oscillator for Display Clock Generation
  - Timing Controller
- Build-In NV Memory for LCD Initial Register Setting
  - 4-bits for ID2
  - 5-bits for flicker adjustment
- Driving Algorithm
  - Dot Inversion

- Column Inversion
- Wide Supply Voltage Range
  - I/O Voltage (VDDI to DGND): 1.65V ~ 3.3V
  - Analog Voltage (VDD to AGND): 2.5V ~ 3.3V
- On-Chip Power System
  - Source Voltage (GVDD to GVCL): +4.7~-4.7V
  - VCOM level: -0.425V ~ -2V
  - Gate driver HIGH level (VGH to AGND): +10.0V ~ +15V
  - Gate driver LOW level (VGL to AGND): -13V ~ -7.5V
- Optimized layout for COG Assembly
- Operate temperature range: -30°C to +85°C
- Lower Power Consumption

Preliminary

3 PAD ARRANGEMENT

3.1.. Pad Arrangement

Au bump height	12μm
Au bump size	16μm×85μm Gate : G1~G220
	Source : S1~S528
	40μm×36μm Input Pads : Pad1 to Pad215

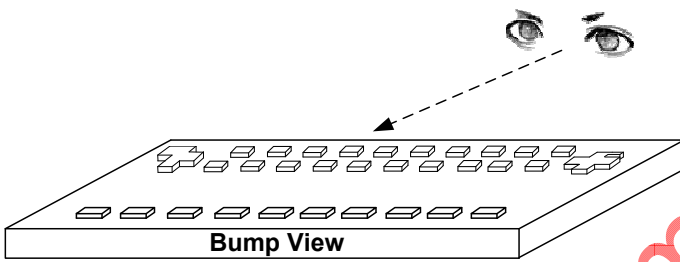

Preliminary

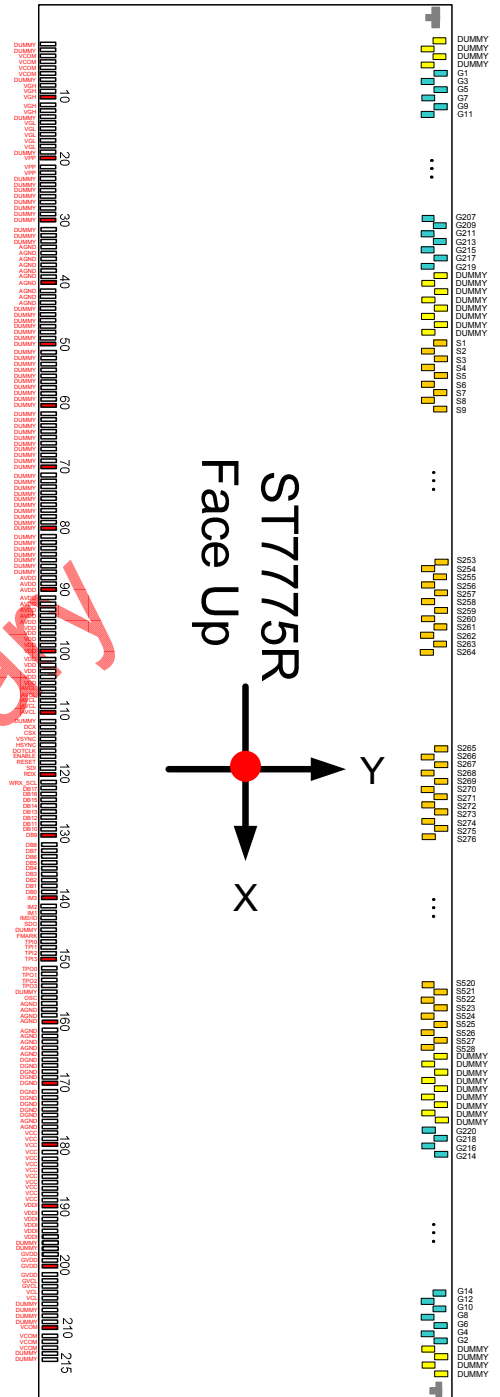

3.2.. Bump Dimension

● output Pads

S1~S528、G1~G220、DUMMY

(No.216~988)

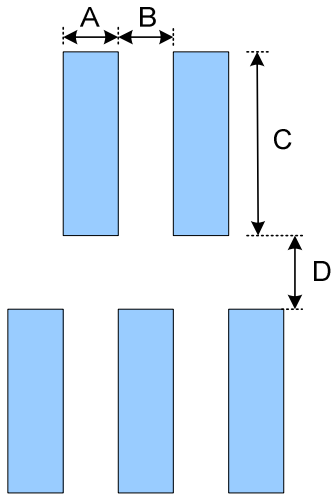

Symbol	Item	Size
A	Bump Width	16 um
B	Bump Gap 1 (Horizontal)	16 um
C	Bump Height	85 um
D	Bump Gap 2 (Vertical)	68 um

● input Pads

I/O Pads

(No.1~215)

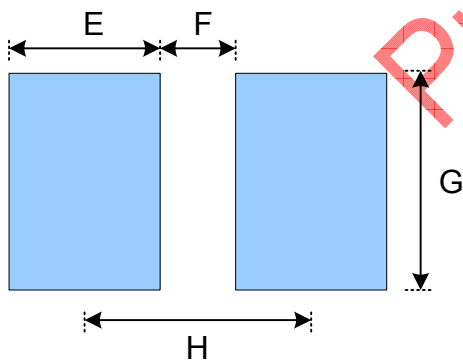

Symbol	Item	Size
E	Bump Width	40 um
F	Bump Gap	20、45 um
G	Bump Height	46 um
H	Bump Pitch	60、85 um

Preliminary

3.3.. Alignment Mark Dimension

- Alignment Mark: A1(X,Y)=(-6852.5,266.5)

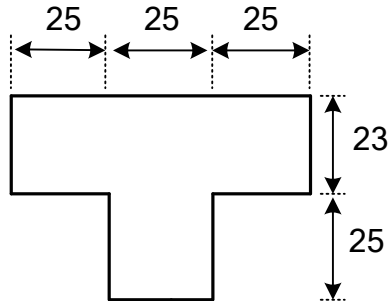

- Alignment Mark: A2(X,Y)=(6852.5,266.5)

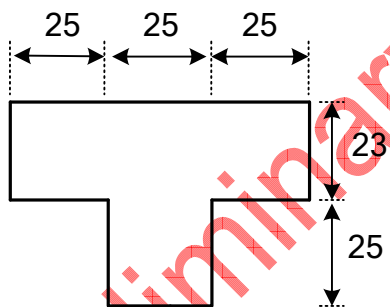

Preliminary

3.4.. Chip Information

Chip size	14000µm x660µm
Chip thickness	300µm
Pad Location	Pad center
Coordinate Origin	Chip center

## 4 PAD CENTER COORDINATES

PAD No.	PIN Name	X	Y	PAD No.	PIN Name	X	Y
1	DUMMY	-6695	-251	34	AGND	-4715	-251
2	DUMMY	-6635	-251	35	AGND	-4655	-251
3	VCOM	-6575	-251	36	AGND	-4595	-251
4	VCOM	-6515	-251	37	AGND	-4535	-251
5	VCOM	-6455	-251	38	AGND	-4475	-251
6	VCOM	-6395	-251	39	AGND	-4415	-251
7	DUMMY	-6335	-251	40	AGND	-4355	-251
8	VGH	-6275	-251	41	AGND	-4295	-251
9	VGH	-6215	-251	42	AGND	-4235	-251
10	VGH	-6155	-251	43	AGND	-4175	-251
11	VGH	-6095	-251	44	DUMMY	-4115	-251
12	VGH	-6035	-251	45	DUMMY	-4055	-251
13	DUMMY	-5975	-251	46	DUMMY	-3995	-251
14	VGL	-5915	-251	47	DUMMY	-3935	-251
15	VGL	-5855	-251	48	DUMMY	-3875	-251
16	VGL	-5795	-251	49	DUMMY	-3815	-251
17	VGL	-5735	-251	50	DUMMY	-3755	-251
18	VGL	-5675	-251	51	DUMMY	-3695	-251
19	DUMMY	-5615	-251	52	DUMMY	-3635	-251
20	VPP	-5555	-251	53	DUMMY	-3575	-251
21	VPP	-5495	-251	54	DUMMY	-3515	-251
22	VPP	-5435	-251	55	DUMMY	-3455	-251
23	DUMMY	-5375	-251	56	DUMMY	-3395	-251
24	DUMMY	-5315	-251	57	DUMMY	-3335	-251
25	DUMMY	-5255	-251	58	DUMMY	-3275	-251
26	DUMMY	-5195	-251	59	DUMMY	-3215	-251
27	DUMMY	-5135	-251	60	DUMMY	-3155	-251
28	DUMMY	-5075	-251	61	DUMMY	-3095	-251
29	DUMMY	-5015	-251	62	DUMMY	-3035	-251
30	DUMMY	-4955	-251	63	DUMMY	-2975	-251
31	DUMMY	-4895	-251	64	DUMMY	-2915	-251
32	DUMMY	-4835	-251	65	DUMMY	-2855	-251
33	DUMMY	-4775	-251	66	DUMMY	-2795	-251

PAD No.	PIN Name	X	Y	PAD No.	PIN Name	X	Y
67	DUMMY	-2735	-251	101	VDD	-695	-251
68	DUMMY	-2675	-251	102	VDD	-635	-251
69	DUMMY	-2615	-251	103	VDD	-575	-251
70	DUMMY	-2555	-251	104	VDD	-515	-251
71	DUMMY	-2495	-251	105	VDD	-455	-251
72	DUMMY	-2435	-251	106	AVCL	-395	-251
73	DUMMY	-2375	-251	107	AVCL	-335	-251
74	DUMMY	-2315	-251	108	AVCL	-275	-251
75	DUMMY	-2255	-251	109	AVCL	-215	-251
76	DUMMY	-2195	-251	110	AVCL	-155	-251
77	DUMMY	-2135	-251	111	DUMMY	-95	-251
78	DUMMY	-2075	-251	112	DCX(RS)	-35	-251
79	DUMMY	-2015	-251	113	CSX	25	-251
80	DUMMY	-1955	-251	114	VSYNC	85	-251
81	DUMMY	-1895	-251	115	HSYNC	145	-251
82	DUMMY	-1835	-251	116	DOTCLK	205	-251
83	DUMMY	-1775	-251	117	ENABLE	265	-251
84	DUMMY	-1715	-251	118	RESET	325	-251
85	DUMMY	-1655	-251	119	SDI(SDA)	385	-251
86	DUMMY	-1595	-251	120	RDX	445	-251
87	DUMMY	-1535	-251	121	WRX(SCL)	505	-251
88	AVDD	-1475	-251	122	DB17	565	-251
89	AVDD	-1415	-251	123	DB16	650	-251
90	AVDD	-1355	-251	124	DB15	735	-251
91	AVDD	-1295	-251	125	DB14	820	-251
92	AVDD	-1235	-251	126	DB13	905	-251
93	AVDD	-1175	-251	127	DB12	990	-251
94	AVDD	-1115	-251	128	DB11	1075	-251
95	AVDD	-1055	-251	129	DB10	1160	-251
96	VDD	-995	-251	130	DB9	1245	-251
97	VDD	-935	-251	131	DB8	1330	-251
98	VDD	-875	-251	132	DB7	1415	-251
99	VDD	-815	-251	133	DB6	1500	-251
100	VDD	-755	-251	134	DB5	1585	-251

PAD No.	PIN Name	X	Y	PAD No.	PIN Name	X	Y
135	DB4	1670	-251	169	DGND	3935	-251
136	DB3	1755	-251	170	DGND	3995	-251
137	DB2	1840	-251	171	DGND	4055	-251
138	DB1	1925	-251	172	DGND	4115	-251
139	DB0	2010	-251	173	DGND	4175	-251
140	IM3	2095	-251	174	DGND	4235	-251
141	IM2	2155	-251	175	DGND	4295	-251
142	IM1	2215	-251	176	AGND	4355	-251
143	IM0_ID	2275	-251	177	AGND	4415	-251
144	SDO	2335	-251	178	VCC	4475	-251
145	DUMMY	2420	-251	179	VCC	4535	-251
146	FMARK	2505	-251	180	VCC	4595	-251
147	TPI0	2590	-251	181	VCC	4655	-251
148	TPI1	2675	-251	182	VCC	4715	-251
149	TPI2	2735	-251	183	VCC	4775	-251
150	TPI3	2795	-251	184	VCC	4835	-251
151	TPO0	2855	-251	185	VCC	4895	-251
152	TPO1	2915	-251	186	VCC	4955	-251
153	TPO2	2975	-251	187	VCC	5015	-251
154	TPO3	3035	-251	188	VCC	5075	-251
155	DUMMY	3095	-251	189	VCC	5135	-251
156	OSC	3155	-251	190	VDDI	5195	-251
157	AGND	3215	-251	191	VDDI	5255	-251
158	AGND	3275	-251	192	VDDI	5315	-251
159	AGND	3335	-251	193	VDDI	5375	-251
160	AGND	3395	-251	194	VDDI	5435	-251
161	AGND	3455	-251	195	VDDI	5495	-251
162	AGND	3515	-251	196	DUMMY	5555	-251
163	AGND	3575	-251	197	DUMMY	5615	-251
164	AGND	3635	-251	198	GVDD	5675	-251
165	AGND	3695	-251	199	GVDD	5735	-251
166	DGND	3755	-251	200	GVDD	5795	-251
167	DGND	3815	-251	201	GVDD	5855	-251
168	DGND	3875	-251	202	GVCL	5915	-251



PAD No.	PIN Name	X	Y	PAD No.	PIN Name	X	Y
203	GVCL	5975	-251	237	G36	6436	77
204	VCL	6035	-251	238	G38	6420	230
205	VCL	6095	-251	239	G40	6404	77
206	DUMMY	6155	-251	240	G42	6388	230
207	DUMMY	6215	-251	241	G44	6372	77
208	DUMMY	6275	-251	242	G46	6356	230
209	DUMMY	6335	-251	243	G48	6340	77
210	VCOM	6395	-251	244	G50	6324	230
211	VCOM	6455	-251	245	G52	6308	77
212	VCOM	6515	-251	246	G54	6292	230
213	VCOM	6575	-251	247	G56	6276	77
214	DUMMY	6635	-251	248	G58	6260	230
215	DUMMY	6695	-251	249	G60	6244	77
216	DUMMY	6772	230	250	G62	6228	230
217	DUMMY	6756	77	251	G64	6212	77
218	DUMMY	6740	230	252	G66	6196	230
219	DUMMY	6724	77	253	G68	6180	77
220	G2	6708	230	254	G70	6164	230
221	G4	6692	77	255	G72	6148	77
222	G6	6676	230	256	G74	6132	230
223	G8	6660	77	257	G76	6116	77
224	G10	6644	230	258	G78	6100	230
225	G12	6628	77	259	G80	6084	77
226	G14	6612	230	260	G82	6068	230
227	G16	6596	77	261	G84	6052	77
228	G18	6580	230	262	G86	6036	230
229	G20	6564	77	263	G88	6020	77
230	G22	6548	230	264	G90	6004	230
231	G24	6532	77	265	G92	5988	77
232	G26	6516	230	266	G94	5972	230
233	G28	6500	77	267	G96	5956	77
234	G30	6484	230	268	G98	5940	230
235	G32	6468	77	269	G100	5924	77
236	G34	6452	230	270	G102	5908	230

PAD No.	PIN Name	X	Y	PAD No.	PIN Name	X	Y
271	G104	5892	77	305	G172	5348	77
272	G106	5876	230	306	G174	5332	230
273	G108	5860	77	307	G176	5316	77
274	G110	5844	230	308	G178	5300	230
275	G112	5828	77	309	G180	5284	77
276	G114	5812	230	310	G182	5268	230
277	G116	5796	77	311	G184	5252	77
278	G118	5780	230	312	G186	5236	230
279	G120	5764	77	313	G188	5220	77
280	G122	5748	230	314	G190	5204	230
281	G124	5732	77	315	G192	5188	77
282	G126	5716	230	316	G194	5172	230
283	G128	5700	77	317	G196	5156	77
284	G130	5684	230	318	G198	5140	230
285	G132	5668	77	319	G200	5124	77
286	G134	5652	230	320	G202	5108	230
287	G136	5636	77	321	G204	5092	77
288	G138	5620	230	322	G206	5076	230
289	G140	5604	77	323	G208	5060	77
290	G142	5588	230	324	G210	5044	230
291	G144	5572	77	325	G212	5028	77
292	G146	5556	230	326	G214	5012	230
293	G148	5540	77	327	G216	4996	77
294	G150	5524	230	328	G218	4980	230
295	G152	5508	77	329	G220	4964	77
296	G154	5492	230	330	DUMMY	4948	230
297	G156	5476	77	331	DUMMY	4932	77
298	G158	5460	230	332	DUMMY	4916	230
299	G160	5444	77	333	DUMMY	4900	77
300	G162	5428	230	334	DUMMY	4884	230
301	G164	5412	77	335	DUMMY	4868	77
302	G166	5396	230	336	DUMMY	4852	230
303	G168	5380	77	337	DUMMY	4836	77
304	G170	5364	230	338	DUMMY	4820	230

PAD No.	PIN Name	X	Y	PAD No.	PIN Name	X	Y
339	S528	4804	77	373	S494	4260	77
340	S527	4788	230	374	S493	4244	230
341	S526	4772	77	375	S492	4228	77
342	S525	4756	230	376	S491	4212	230
343	S524	4740	77	377	S490	4196	77
344	S523	4724	230	378	S489	4180	230
345	S522	4708	77	379	S488	4164	77
346	S521	4692	230	380	S487	4148	230
347	S520	4676	77	381	S486	4132	77
348	S519	4660	230	382	S485	4116	230
349	S518	4644	77	383	S484	4100	77
350	S517	4628	230	384	S483	4084	230
351	S516	4612	77	385	S482	4068	77
352	S515	4596	230	386	S481	4052	230
353	S514	4580	77	387	S480	4036	77
354	S513	4564	230	388	S479	4020	230
355	S512	4548	77	389	S478	4004	77
356	S511	4532	230	390	S477	3988	230
357	S510	4516	77	391	S476	3972	77
358	S509	4500	230	392	S475	3956	230
359	S508	4484	77	393	S474	3940	77
360	S507	4468	230	394	S473	3924	230
361	S506	4452	77	395	S472	3908	77
362	S505	4436	230	396	S471	3892	230
363	S504	4420	77	397	S470	3876	77
364	S503	4404	230	398	S469	3860	230
365	S502	4388	77	399	S468	3844	77
366	S501	4372	230	400	S467	3828	230
367	S500	4356	77	401	S466	3812	77
368	S499	4340	230	402	S465	3796	230
369	S498	4324	77	403	S464	3780	77
370	S497	4308	230	404	S463	3764	230
371	S496	4292	77	405	S462	3748	77
372	S495	4276	230	406	S461	3732	230

PAD No.	PIN Name	X	Y	PAD No.	PIN Name	X	Y
407	S460	3716	77	441	S426	3172	77
408	S459	3700	230	442	S425	3156	230
409	S458	3684	77	443	S424	3140	77
410	S457	3668	230	444	S423	3124	230
411	S456	3652	77	445	S422	3108	77
412	S455	3636	230	446	S421	3092	230
413	S454	3620	77	447	S420	3076	77
414	S453	3604	230	448	S419	3060	230
415	S452	3588	77	449	S418	3044	77
416	S451	3572	230	450	S417	3028	230
417	S450	3556	77	451	S416	3012	77
418	S449	3540	230	452	S415	2996	230
419	S448	3524	77	453	S414	2980	77
420	S447	3508	230	454	S413	2964	230
421	S446	3492	77	455	S412	2948	77
422	S445	3476	230	456	S411	2932	230
423	S444	3460	77	457	S410	2916	77
424	S443	3444	230	458	S409	2900	230
425	S442	3428	77	459	S408	2884	77
426	S441	3412	230	460	S407	2868	230
427	S440	3396	77	461	S406	2852	77
428	S439	3380	230	462	S405	2836	230
429	S438	3364	77	463	S404	2820	77
430	S437	3348	230	464	S403	2804	230
431	S436	3332	77	465	S402	2788	77
432	S435	3316	230	466	S401	2772	230
433	S434	3300	77	467	S400	2756	77
434	S433	3284	230	468	S399	2740	230
435	S432	3268	77	469	S398	2724	77
436	S431	3252	230	470	S397	2708	230
437	S430	3236	77	471	S396	2642	77
438	S429	3220	230	472	S395	2626	230
439	S428	3204	77	473	S394	2610	77
440	S427	3188	230	474	S393	2594	230

PAD No.	PIN Name	X	Y	PAD No.	PIN Name	X	Y
475	S392	2578	77	509	S358	2034	77
476	S391	2562	230	510	S357	2018	230
477	S390	2546	77	511	S356	2002	77
478	S389	2530	230	512	S355	1986	230
479	S388	2514	77	513	S354	1970	77
480	S387	2498	230	514	S353	1954	230
481	S386	2482	77	515	S352	1938	77
482	S385	2466	230	516	S351	1922	230
483	S384	2450	77	517	S350	1906	77
484	S383	2434	230	518	S349	1890	230
485	S382	2418	77	519	S348	1874	77
486	S381	2402	230	520	S347	1858	230
487	S380	2386	77	521	S346	1842	77
488	S379	2370	230	522	S345	1826	230
489	S378	2354	77	523	S344	1810	77
490	S377	2338	230	524	S343	1794	230
491	S376	2322	77	525	S342	1778	77
492	S375	2306	230	526	S341	1762	230
493	S374	2290	77	527	S340	1746	77
494	S373	2274	230	528	S339	1730	230
495	S372	2258	77	529	S338	1714	77
496	S371	2242	230	530	S337	1698	230
497	S370	2226	77	531	S336	1682	77
498	S369	2210	230	532	S335	1666	230
499	S368	2194	77	533	S334	1650	77
500	S367	2178	230	534	S333	1634	230
501	S366	2162	77	535	S332	1618	77
502	S365	2146	230	536	S331	1602	230
503	S364	2130	77	537	S330	1586	77
504	S363	2114	230	538	S329	1570	230
505	S362	2098	77	539	S328	1554	77
506	S361	2082	230	540	S327	1538	230
507	S360	2066	77	541	S326	1522	77
508	S359	2050	230	542	S325	1506	230

PAD No.	PIN Name	X	Y	PAD No.	PIN Name	X	Y
543	S324	1490	77	577	S290	946	77
544	S323	1474	230	578	S289	930	230
545	S322	1458	77	579	S288	914	77
546	S321	1442	230	580	S287	898	230
547	S320	1426	77	581	S286	882	77
548	S319	1410	230	582	S285	866	230
549	S318	1394	77	583	S284	850	77
550	S317	1378	230	584	S283	834	230
551	S316	1362	77	585	S282	818	77
552	S315	1346	230	586	S281	802	230
553	S314	1330	77	587	S280	786	77
554	S313	1314	230	588	S279	770	230
555	S312	1298	77	589	S278	754	77
556	S311	1282	230	590	S277	738	230
557	S310	1266	77	591	S276	722	77
558	S309	1250	230	592	S275	706	230
559	S308	1234	77	593	S274	690	77
560	S307	1218	230	594	S273	674	230
561	S306	1202	77	595	S272	658	77
562	S305	1186	230	596	S271	642	230
563	S304	1170	77	597	S270	626	77
564	S303	1154	230	598	S269	610	230
565	S302	1138	77	599	S268	594	77
566	S301	1122	230	600	S267	578	230
567	S300	1106	77	601	S266	562	77
568	S299	1090	230	602	S265	546	230
569	S298	1074	77	603	S264	-554	77
570	S297	1058	230	604	S263	-570	230
571	S296	1042	77	605	S262	-586	77
572	S295	1026	230	606	S261	-602	230
573	S294	1010	77	607	S260	-618	77
574	S293	994	230	608	S259	-634	230
575	S292	978	77	609	S258	-650	77
576	S291	962	230	610	S257	-666	230

PAD No.	PIN Name	X	Y	PAD No.	PIN Name	X	Y
611	S256	-682	77	645	S222	-1226	77
612	S255	-698	230	646	S221	-1242	230
613	S254	-714	77	647	S220	-1258	77
614	S253	-730	230	648	S219	-1274	230
615	S252	-746	77	649	S218	-1290	77
616	S251	-762	230	650	S217	-1306	230
617	S250	-778	77	651	S216	-1322	77
618	S249	-794	230	652	S215	-1338	230
619	S248	-810	77	653	S214	-1354	77
620	S247	-826	230	654	S213	-1370	230
621	S246	-842	77	655	S212	-1386	77
622	S245	-858	230	656	S211	-1402	230
623	S244	-874	77	657	S210	-1418	77
624	S243	-890	230	658	S209	-1434	230
625	S242	-906	77	659	S208	-1450	77
626	S241	-922	230	660	S207	-1466	230
627	S240	-938	77	661	S206	-1482	77
628	S239	-954	230	662	S205	-1498	230
629	S238	-970	77	663	S204	-1514	77
630	S237	-986	230	664	S203	-1530	230
631	S236	-1002	77	665	S202	-1546	77
632	S235	-1018	230	666	S201	-1562	230
633	S234	-1034	77	667	S200	-1578	77
634	S233	-1050	230	668	S199	-1594	230
635	S232	-1066	77	669	S198	-1610	77
636	S231	-1082	230	670	S197	-1626	230
637	S230	-1098	77	671	S196	-1642	77
638	S229	-1114	230	672	S195	-1658	230
639	S228	-1130	77	673	S194	-1674	77
640	S227	-1146	230	674	S193	-1690	230
641	S226	-1162	77	675	S192	-1706	77
642	S225	-1178	230	676	S191	-1722	230
643	S224	-1194	77	677	S190	-1738	77
644	S223	-1210	230	678	S189	-1754	230

PAD No.	PIN Name	X	Y	PAD No.	PIN Name	X	Y
679	S188	-1770	77	713	S154	-2314	77
680	S187	-1786	230	714	S153	-2330	230
681	S186	-1802	77	715	S152	-2346	77
682	S185	-1818	230	716	S151	-2362	230
683	S184	-1834	77	717	S150	-2378	77
684	S183	-1850	230	718	S149	-2394	230
685	S182	-1866	77	719	S148	-2410	77
686	S181	-1882	230	720	S147	-2426	230
687	S180	-1898	77	721	S146	-2442	77
688	S179	-1914	230	722	S145	-2458	230
689	S178	-1930	77	723	S144	-2474	77
690	S177	-1946	230	724	S143	-2490	230
691	S176	-1962	77	725	S142	-2506	77
692	S175	-1978	230	726	S141	-2522	230
693	S174	-1994	77	727	S140	-2538	77
694	S173	-2010	230	728	S139	-2554	230
695	S172	-2026	77	729	S138	-2570	77
696	S171	-2042	230	730	S137	-2586	230
697	S170	-2058	77	731	S136	-2602	77
698	S169	-2074	230	732	S135	-2618	230
699	S168	-2090	77	733	S134	-2634	77
700	S167	-2106	230	734	S133	-2650	230
701	S166	-2122	77	735	S132	-2716	77
702	S165	-2138	230	736	S131	-2732	230
703	S164	-2154	77	737	S130	-2748	77
704	S163	-2170	230	738	S129	-2764	230
705	S162	-2186	77	739	S128	-2780	77
706	S161	-2202	230	740	S127	-2796	230
707	S160	-2218	77	741	S126	-2812	77
708	S159	-2234	230	742	S125	-2828	230
709	S158	-2250	77	743	S124	-2844	77
710	S157	-2266	230	744	S123	-2860	230
711	S156	-2282	77	745	S122	-2876	77
712	S155	-2298	230	746	S121	-2892	230



PAD No.	PIN Name	X	Y	PAD No.	PIN Name	X	Y
747	S120	-2908	77	781	S86	-3452	77
748	S119	-2924	230	782	S85	-3468	230
749	S118	-2940	77	783	S84	-3484	77
750	S117	-2956	230	784	S83	-3500	230
751	S116	-2972	77	785	S82	-3516	77
752	S115	-2988	230	786	S81	-3532	230
753	S114	-3004	77	787	S80	-3548	77
754	S113	-3020	230	788	S79	-3564	230
755	S112	-3036	77	789	S78	-3580	77
756	S111	-3052	230	790	S77	-3596	230
757	S110	-3068	77	791	S76	-3612	77
758	S109	-3084	230	792	S75	-3628	230
759	S108	-3100	77	793	S74	-3644	77
760	S107	-3116	230	794	S73	-3660	230
761	S106	-3132	77	795	S72	-3676	77
762	S105	-3148	230	796	S71	-3692	230
763	S104	-3164	77	797	S70	-3708	77
764	S103	-3180	230	798	S69	-3724	230
765	S102	-3196	77	799	S68	-3740	77
766	S101	-3212	230	800	S67	-3756	230
767	S100	-3228	77	801	S66	-3772	77
768	S99	-3244	230	802	S65	-3788	230
769	S98	-3260	77	803	S64	-3804	77
770	S97	-3276	230	804	S63	-3820	230
771	S96	-3292	77	805	S62	-3836	77
772	S95	-3308	230	806	S61	-3852	230
773	S94	-3324	77	807	S60	-3868	77
774	S93	-3340	230	808	S59	-3884	230
775	S92	-3356	77	809	S58	-3900	77
776	S91	-3372	230	810	S57	-3916	230
777	S90	-3388	77	811	S56	-3932	77
778	S89	-3404	230	812	S55	-3948	230
779	S88	-3420	77	813	S54	-3964	77
780	S87	-3436	230	814	S53	-3980	230

PAD No.	PIN Name	X	Y	PAD No.	PIN Name	X	Y
815	S52	-3996	77	849	S18	-4540	77
816	S51	-4012	230	850	S17	-4556	230
817	S50	-4028	77	851	S16	-4572	77
818	S49	-4044	230	852	S15	-4588	230
819	S48	-4060	77	853	S14	-4604	77
820	S47	-4076	230	854	S13	-4620	230
821	S46	-4092	77	855	S12	-4636	77
822	S45	-4108	230	856	S11	-4652	230
823	S44	-4124	77	857	S10	-4668	77
824	S43	-4140	230	858	S9	-4684	230
825	S42	-4156	77	859	S8	-4700	77
826	S41	-4172	230	860	S7	-4716	230
827	S40	-4188	77	861	S6	-4732	77
828	S39	-4204	230	862	S5	-4748	230
829	S38	-4220	77	863	S4	-4764	77
830	S37	-4236	230	864	S3	-4780	230
831	S36	-4252	77	865	S2	-4796	77
832	S35	-4268	230	866	S1	-4812	230
833	S34	-4284	77	867	DUMMY	-4828	77
834	S33	-4300	230	868	DUMMY	-4844	230
835	S32	-4316	77	869	DUMMY	-4860	77
836	S31	-4332	230	870	DUMMY	-4876	230
837	S30	-4348	77	871	DUMMY	-4892	77
838	S29	-4364	230	872	DUMMY	-4908	230
839	S28	-4380	77	873	DUMMY	-4924	77
840	S27	-4396	230	874	DUMMY	-4940	230
841	S26	-4412	77	875	G219	-4956	77
842	S25	-4428	230	876	G217	-4972	230
843	S24	-4444	77	877	G215	-4988	77
844	S23	-4460	230	878	G213	-5004	230
845	S22	-4476	77	879	G211	-5020	77
846	S21	-4492	230	880	G209	-5036	230
847	S20	-4508	77	881	G207	-5052	77
848	S19	-4524	230	882	G205	-5068	230

PAD No.	PIN Name	X	Y	PAD No.	PIN Name	X	Y
883	G203	-5084	77	917	G135	-5628	77
884	G201	-5100	230	918	G133	-5644	230
885	G199	-5116	77	919	G131	-5660	77
886	G197	-5132	230	920	G129	-5676	230
887	G195	-5148	77	921	G127	-5692	77
888	G193	-5164	230	922	G125	-5708	230
889	G191	-5180	77	923	G123	-5724	77
890	G189	-5196	230	924	G121	-5740	230
891	G187	-5212	77	925	G119	-5756	77
892	G185	-5228	230	926	G117	-5772	230
893	G183	-5244	77	927	G115	-5788	77
894	G181	-5260	230	928	G113	-5804	230
895	G179	-5276	77	929	G111	-5820	77
896	G177	-5292	230	930	G109	-5836	230
897	G175	-5308	77	931	G107	-5852	77
898	G173	-5324	230	932	G105	-5868	230
899	G171	-5340	77	933	G103	-5884	77
900	G169	-5356	230	934	G101	-5900	230
901	G167	-5372	77	935	G99	-5916	77
902	G165	-5388	230	936	G97	-5932	230
903	G163	-5404	77	937	G95	-5948	77
904	G161	-5420	230	938	G93	-5964	230
905	G159	-5436	77	939	G91	-5980	77
906	G157	-5452	230	940	G89	-5996	230
907	G155	-5468	77	941	G87	-6012	77
908	G153	-5484	230	942	G85	-6028	230
909	G151	-5500	77	943	G83	-6044	77
910	G149	-5516	230	944	G81	-6060	230
911	G147	-5532	77	945	G79	-6076	77
912	G145	-5548	230	946	G77	-6092	230
913	G143	-5564	77	947	G75	-6108	77
914	G141	-5580	230	948	G73	-6124	230
915	G139	-5596	77	949	G71	-6140	77
916	G137	-5612	230	950	G69	-6156	230

PAD No.	PIN Name	X	Y	PAD No.	PIN Name	X	Y
951	G67	-6172	77	985	DUMMY	-6716	77
952	G65	-6188	230	986	DUMMY	-6732	230
953	G63	-6204	77	987	DUMMY	-6748	77
954	G61	-6220	230	988	DUMMY	-6764	230
955	G59	-6236	77				
956	G57	-6252	230				
957	G55	-6268	77				
958	G53	-6284	230				
959	G51	-6300	77				
960	G49	-6316	230				
961	G47	-6332	77				
962	G45	-6348	230				
963	G43	-6364	77				
964	G41	-6380	230				
965	G39	-6396	77				
966	G37	-6412	230				
967	G35	-6428	77				
968	G33	-6444	230				
969	G31	-6460	77				
970	G29	-6476	230				
971	G27	-6492	77				
972	G25	-6508	230				
973	G23	-6524	77				
974	G21	-6540	230				
975	G19	-6556	77				
976	G17	-6572	230				
977	G15	-6588	77				
978	G13	-6604	230				
979	G11	-6620	77				
980	G9	-6636	230				
981	G7	-6652	77				
982	G5	-6668	230				
983	G3	-6684	77				
984	G1	-6700	230				

Preliminary

5 BLOCK DIAGRAM

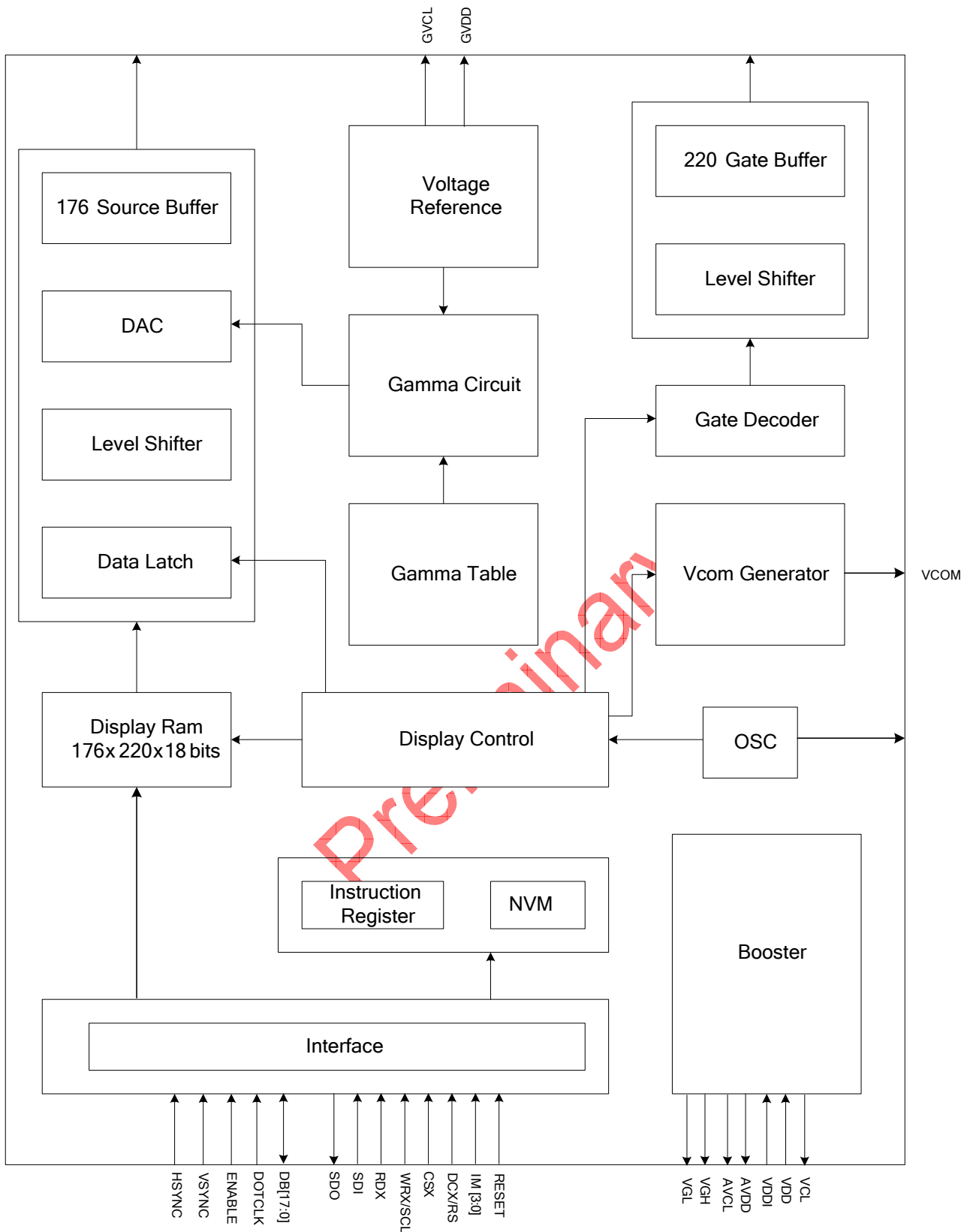

**6 PIN DESCRIPTION**

## 6.1.. Power Supply Pins

Name	I/O	Description	Connect Pin
VDD	I	Power Supply for Analog, Digital System and Booster Circuit.	VDD
VDDI	I	Power Supply for I/O System.	VDDI
AGND	I	System Ground for Analog System and Booster Circuit.	GND
DGND	I	System Ground for I/O System and Digital System.	GND

Preliminary

6.2.. Interface Logic Pins

Name	I/O	Description	Connect Pin																																																																														
IM3, IM2, IM1, IM0/ID	I	-The MCU interface mode select.	DGND/VDDI																																																																														
		<table border="1"> <thead> <tr> <th>IM3</th> <th>IM2</th> <th>IM1</th> <th>IM0</th> <th>MCU Interface Mode</th> <th>Data pin</th> </tr> </thead> <tbody> <tr> <td>0</td> <td>0</td> <td>0</td> <td>0</td> <td>68-16 bit</td> <td>DB[17:10], DB[8:1]</td> </tr> <tr> <td>0</td> <td>0</td> <td>0</td> <td>1</td> <td>68-8 bit</td> <td>DB[17:10]</td> </tr> <tr> <td>0</td> <td>0</td> <td>1</td> <td>0</td> <td>80-16 bit</td> <td>DB[17:10], DB[8:1]</td> </tr> <tr> <td>0</td> <td>0</td> <td>1</td> <td>1</td> <td>80-8 bit</td> <td>DB[17:10],</td> </tr> <tr> <td>0</td> <td>1</td> <td>0</td> <td>ID</td> <td>24-bit SPI</td> <td>CSX ,SCL ,SDI, SDO</td> </tr> <tr> <td>0</td> <td>1</td> <td>1</td> <td>0</td> <td>9- bit SPI</td> <td>CSX,SCL,SDA</td> </tr> <tr> <td>0</td> <td>1</td> <td>1</td> <td>1</td> <td>8- bit SPI</td> <td>CSX,SCL,SDA,DCX</td> </tr> <tr> <td>1</td> <td>0</td> <td>0</td> <td>0</td> <td>68-18 bit</td> <td>DB[17:0]</td> </tr> <tr> <td>1</td> <td>0</td> <td>0</td> <td>1</td> <td>68-9 bit</td> <td>DB[17:9]</td> </tr> <tr> <td>1</td> <td>0</td> <td>1</td> <td>0</td> <td>80-18bit</td> <td>DB[17:0]</td> </tr> <tr> <td>1</td> <td>0</td> <td>1</td> <td>1</td> <td>80-9bit</td> <td>DB[17:9]</td> </tr> <tr> <td>1</td> <td>1</td> <td>--</td> <td>--</td> <td>Setting invalid</td> <td></td> </tr> </tbody> </table>		IM3	IM2	IM1	IM0	MCU Interface Mode	Data pin	0	0	0	0	68-16 bit	DB[17:10], DB[8:1]	0	0	0	1	68-8 bit	DB[17:10]	0	0	1	0	80-16 bit	DB[17:10], DB[8:1]	0	0	1	1	80-8 bit	DB[17:10],	0	1	0	ID	24-bit SPI	CSX ,SCL ,SDI, SDO	0	1	1	0	9- bit SPI	CSX,SCL,SDA	0	1	1	1	8- bit SPI	CSX,SCL,SDA,DCX	1	0	0	0	68-18 bit	DB[17:0]	1	0	0	1	68-9 bit	DB[17:9]	1	0	1	0	80-18bit	DB[17:0]	1	0	1	1	80-9bit	DB[17:9]	1	1	--	--	Setting invalid	
		IM3		IM2	IM1	IM0	MCU Interface Mode	Data pin																																																																									
		0		0	0	0	68-16 bit	DB[17:10], DB[8:1]																																																																									
		0		0	0	1	68-8 bit	DB[17:10]																																																																									
		0		0	1	0	80-16 bit	DB[17:10], DB[8:1]																																																																									
		0		0	1	1	80-8 bit	DB[17:10],																																																																									
		0		1	0	ID	24-bit SPI	CSX ,SCL ,SDI, SDO																																																																									
		0		1	1	0	9- bit SPI	CSX,SCL,SDA																																																																									
		0		1	1	1	8- bit SPI	CSX,SCL,SDA,DCX																																																																									
		1		0	0	0	68-18 bit	DB[17:0]																																																																									
		1		0	0	1	68-9 bit	DB[17:9]																																																																									
		1		0	1	0	80-18bit	DB[17:0]																																																																									
1	0	1	1	80-9bit	DB[17:9]																																																																												
1	1	--	--	Setting invalid																																																																													
RESET	I	-This signal will reset the device and it must be applied to properly initialize the chip. -Signal is active low.	MCU																																																																														
CSX	I	-Chip selection pin Low enable. High disable.	MCU																																																																														
DCX (RS)	I	-Display data/command selection pin in MCU interface. DCX='1': display data or parameter. DCX='0': command data. -If not used, please fix this pin at VDDI or DGND level.	MCU																																																																														
RDX	I	-Read enable in 8080 MCU parallel interface. -If not used, please fix this pin at VDDI or DGND level.	MCU																																																																														
WRX (SCL)	I	-Write enable in MCU parallel interface. In SPI mode, this is used as SCL. -If not used, please fix this pin at VDDI or DGND level.	MCU																																																																														
VSYNC	I	-Vertical (Frame) synchronizing input signal for RGB interface operation. VSPL = "0": Active low. VSPL = "1": Active high. -Fix to the GND level when not in use.	MCU																																																																														

Name	I/O	Description	Connect Pin
HSYNC	I	-Horizontal (Line) synchronizing input signal for RGB interface operation. HSPL = "0": Active low, HSPL = "1": Active high. -Fix to the GND level when not in use	MCU
ENABLE	I	-Data enable signal for RGB interface operation. Low: Select (access enabled), High: Not select (access disabled) The EPL bit inverts the polarity of the ENABLE signal. -If not used, please fix this pin at VDDI or DGND level.	MCU
DOTCLK	I	-Dot clock signal for RGB interface operation. DPL = "0": Input data on the rising edge of DOTCLK DPL = "1": Input data on the falling edge of DOTCLK -If not used, please fix this pin at DGND level.	MCU
SDI (SDA)	I	-SPI interface input pin. -The data is latched on the rising edge of the SCL signal. -In the 24-bit serial peripheral interface, this pin is used as input Pin. -In the 8/9-bit serial peripheral interface, this pin is used as bi-directional data pin. -If not used, please fix this pin at DGND level.	MCU
SDO	I	-SPI interface output pin. -The data is outputted on the falling edge of the SCL signal. If not used, please fix this pin at floating.	MCU
DB[17:0]	I/O	-DB[17:0] are used as MCU parallel interface data bus. 8-bit I/F: DB[17:10] is used. 9-bit I/F: DB[17:9] is used. 16-bit I/F: DB[17:10] and DB[8:1] is used. 18-bit I/F: DB[17:0] is used. -DB[17:0] are used as RGB interface data bus. 6-bit RGB I/F: DB[17:12] are used. 16-bit RGB I/F: DB[17:13] and DB[11:1] are used. 18-bit RGB I/F: DB[17:0] are used. -If not used, please fix this pin at VDDI or DGND level.	MCU
FMARK	O	-Output frame head pulse signal is used as synchronies MCU to frame rate -If not used, Let this pin open	MCU

Note1. "1" = VDDI level, "0" = DGND level.

Note2. When in parallel mode, unused data pins must be connected to "1" or "0".

Note3. When CSX="1", there is no influence to the parallel and serial interface.



6.3.. Driver Output Pins

Name	I/O	Description	Connect pin
S1 to S528	O	-Source driver output pins -To change the shift direction of signal outputs, use the SS bit. SS = "0", the data in the RAM address "h00000" is output from S1. SS = "1", the data in the RAM address "h00000" is output from S528. -When SS="0" S1, S4, S7, ... display red (R), S2, S5, S8, ... display green (G), and S3, S6, S9 ... display blue (B)	LCD
G1 to G220	O	-Gate driver output pins. VGH: Selecting Gate Lines Level. VGL: Non-selecting Gate Lines Level.	LCD
AVDD	O	-Power pad for analog circuit. -Connect a capacitor for stabilization.	Capacitor
GVDD	O	- A power output of grayscale voltage generator. - When internal GVDD generator is not used, connect an external power supply (AVDD-0.5V) to this pin.	-
AVCL	O	- A power supply pin for generating GVCL. - Connect a capacitor for stabilization.	Capacitor
GVCL	O	- A power output (Negative) of grayscale voltage generator. - When internal GVCL generator is not used, connect an external power supply (AVCL+0.5V) to this pin.	-
VCL	O	- A power output of VCOM voltage (Negative) generator.	-
VGH	O	- Power output pin for gate driver	-
VGL	O	- Power output (Negative) pin for gate driver	-
VCC	O	- Monitoring pin of internal digital reference voltage.	-
VCOM	O	-A power supply for the TFT-LCD common electrode.	Common Electrode

6.4.. Test Pins

Name	I/O	Description	Connect pin
TPI0	I	-These test pins for Driver vender test used. Leave this pin open	Open
TPI1 TPI2 TPI3	I	-This pin is for testing. -In normal operation, connect this pin to DGND or VDDI	DGND/VDDI
TPO0 TPO1 TPO2	O	-These test pins for Driver vender test used. -Please open these pins.	Open
TPO3	O	-This pin is for testing -In normal operation, connect this pin to DGND or VDDI	DGND/VDDI
OSC	O	-This pin is for testing. - In normal operation, connect this pin to DGND or VDDI.	DGND/VDDI
Dummy	-	-These pins are dummy (have no function inside). -Can allow signal traces pass through these pads on TFT glass. -Please open these pins.	Open

Preliminary

## 7 DRIVER ELECTRICAL CHARACTERISTICS

### 7.1.. Absolute Operation Range

Item	Symbol	Rating	Unit
Supply Voltage	VDD	- 0.3 ~ +4.6	V
Supply Voltage (Logic)	VDDI	- 0.3 ~ +4.6	V
Supply Voltage (Digital)	VCC	- 0.3 ~ +4.6	V
Driver Supply Voltage	VGH-VGL	- 0.3 ~ +30.0	V
Logic Input Voltage Range	VIN	- 0.5 ~ VDDI + 0.5	V
Logic Output Voltage Range	VO	- 0.5 ~ VDDI + 0.5	V
Operating Temperature Range	TOPR	-30 ~ +85	°C
Storage Temperature Range	TSTG	-40 ~ +125	°C

Table 1 Absolute Operation Range

*Note: If one of the above items is exceeded its maximum limitation momentarily, the quality of the product may be degraded. Absolute maximum limitation, therefore, specify the values exceeding which the product may be physically damaged. Be sure to use the product within the recommend range.*

Preliminary

7.2.. DC Characteristics

Parameter	Symbol	Condition	Specification			Unit	Related Pins
			MIN.	TYP.	MAX.		
Power & Operation Voltage							
System Voltage	VDD	Operating voltage	2.5	2.75	3.3	V	
Interface Operation Voltage	VDDI	I/O Supply Voltage	1.65	1.8	3.3	V	
Gate Driver High Voltage	VGH		10		15	V	
Gate Driver Low Voltage	VGL		-12.4		-7.5	V	
Gate Driver Supply Voltage		VGH-VGL	17.5		27.4	V	
Input / Output							
Logic-High Input Voltage	VIH		0.8VDDI		VDDI	V	Note 1
Logic-Low Input Voltage	VIL		VSS		0.2VDDI	V	Note 1
Logic-High Output Voltage	VOH	IOH = -1.0mA	0.8VDDI		VDDI	V	Note 1
Logic-Low Output Voltage	VOL	IOL = +1.0mA	VSS		0.2VDDI	V	Note 1
Logic-High Input Current	IIH	VIN = VDDI			1	uA	Note 1
Logic-Low Input Current	IIL	VIN = VSS	-1			uA	Note 1
Input Leakage Current	IIL	IOH = -1.0mA	-0.1		+0.1	uA	Note 1
VCOM Voltage							
VCOM amplitude	VCOM		-2		-0.425	V	
Source Driver							
Source Output Range	VSout		GVCL		GVDD	V	
Gamma Reference Voltage(Positive)	GVDD		3.15		4.7	V	
Gamma Reference Voltage(Negative)	GVCL		-4.7		-3.15	V	
Source Output Settling Time	Tr	Below with 99% precision			20	us	Note 2
Output Offset Voltage	VOFFSET				35	mV	Note 3

Table 2 Basic DC Characteristics

Notes:

1. TA= -30 to 85°C.
2. Source channel loading= 2KΩ+12pF/channel, Gate channel loading=5KΩ+40pF/channel.
3. The Max. value is between measured point of source output and gamma setting value.

7.3.. Power Consumption

*Ta=25°C, Frame rate = 60Hz, Registers setting are IC default setting.*

Operation Mode	Image	Current Consumption			
		Typical		Maximum	
		IDD (mA)	IDD (mA)	IDD (mA)	IDD (mA)
Normal Mode	Note 1	TBD	TBD	TBD	TBD
Stand-by Mode	Note 1	TBD	TBD	TBD	TBD

Table 3 Power Consumption

Notes:

1. All pixels black.
2. All pixels white.
3. The Current Consumption is DC characteristics of ST7775R.
4. Typical: VDDI=1.8V, VDD=2.75V; Maximum: VDDI=1.65 to 3.3V, VDD=2.5 to 3.3V

Preliminary



Signal	Symbol	Parameter	Min	Max	Unit	Description
	TRAT	Read Access Time (ID)		TBD	ns	and 30pF Parallel Cap. To GND.
	TODH	Output Disable Time	TBD	TBD	ns	TODH: 3K ohm Pull up or Down.

Table 4 8080 Parallel Interface Characteristics

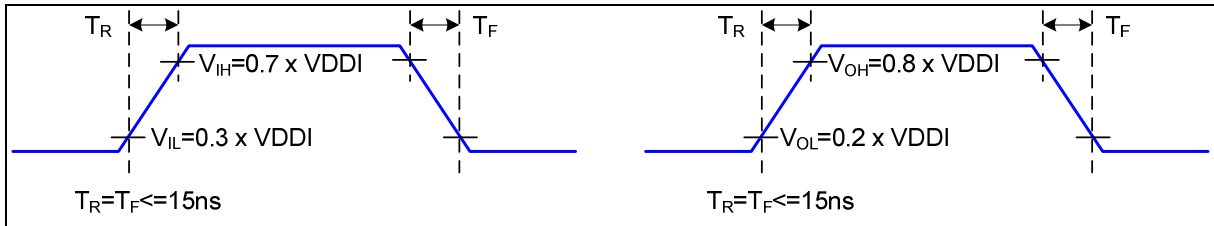

Figure 2 Rising and Falling Timing for I/O Signal

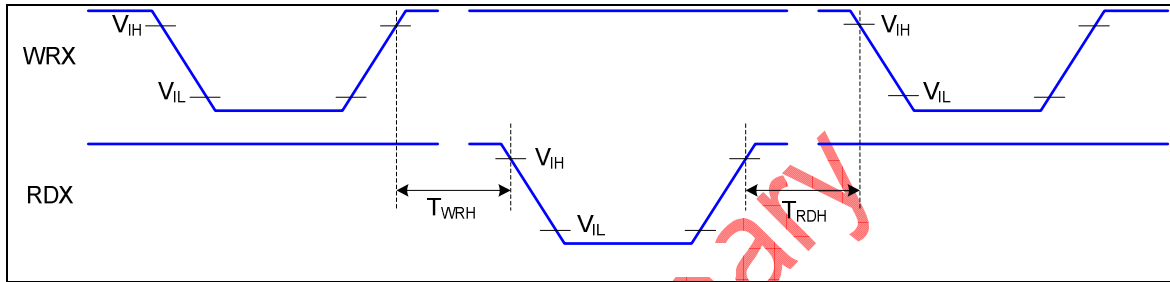

Figure 3 Write-to-Read and Read-to-Write Timing

Note: The rising time and falling time ( $T_r$ ,  $T_f$ ) of input signal and fall time are specified at 15 ns or less. Logic high and low levels are specified as 30% and 70% of VDDI for Input signals.

Preliminary

7.4.2 6800 Series MCU Parallel Interface Characteristics: 18/16/9/8-bit Bus

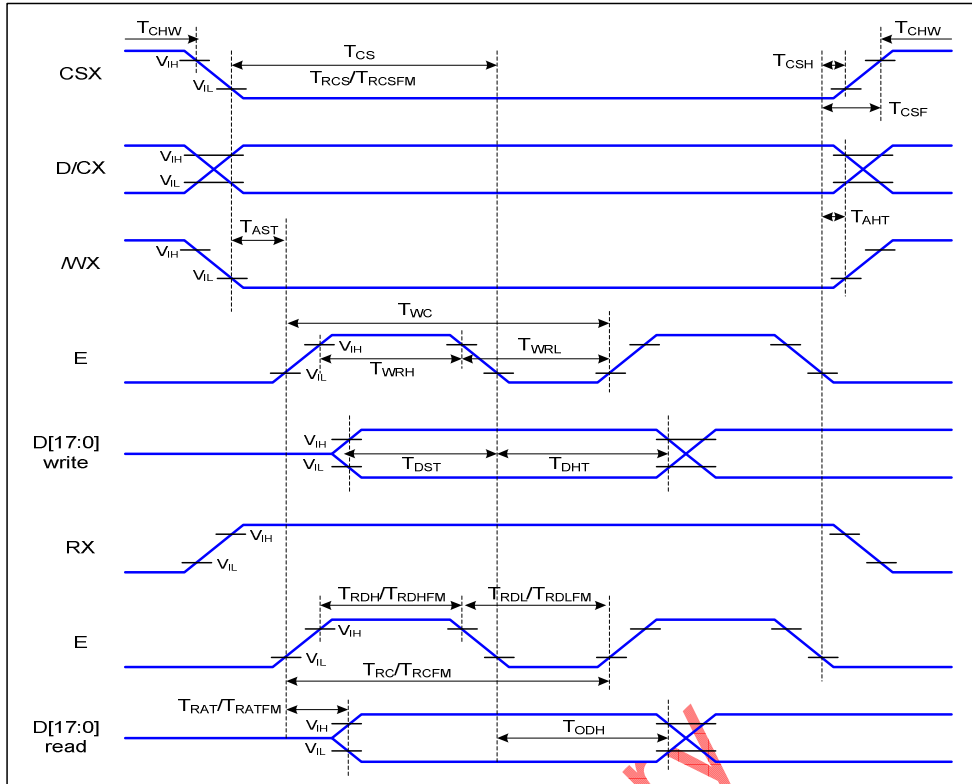

Figure 4 Parallel Interface Timing Characteristics (6800-Series MCU Interface)

VDD1=1.65 to 3.3V, VDD=2.5 to 3.3V, AGND=DGND=0V, Ta=25 °C

Signal	Symbol	Parameter	Min	Max	Unit	Description
DCX	T <sub>AST</sub>	Address setup time	TBD		ns	-
	T <sub>AHT</sub>	Address hold time (Write/Read)	TBD		ns	
E	T <sub>WC</sub>	Write cycle	TBD		ns	
	T <sub>WRH</sub>	Control pulse "H" duration	TBD		ns	
	T <sub>WRL</sub>	Control pulse "L" duration	TBD		ns	
RDX (ID)	T <sub>RC</sub>	Read cycle (ID)	TBD		ns	When read ID data
	T <sub>RDH</sub>	Control pulse "H" duration (ID)	TBD		ns	
	T <sub>RDL</sub>	Control pulse "L" duration (ID)	TBD		ns	
RDX (FM)	T <sub>RCFM</sub>	Read cycle (FM)	TBD		ns	When read from frame memory
	T <sub>RDHFM</sub>	Control pulse "H" duration (FM)	TBD		ns	
	T <sub>RDLFM</sub>	Control pulse "L" duration (FM)	TBD		ns	
DB[17:0]	T <sub>DST</sub>	Data setup time	TBD		ns	For maximum
	T <sub>DHT</sub>	Data hold time	TBD		ns	CL=30pF
	T <sub>ODH</sub>	Output disable time	TBD	TBD	ns	For minimum CL=8pF

Table 5 8080 Parallel Interface Characteristics



7.4.3 Serial Data Transfer Interface Characteristics:

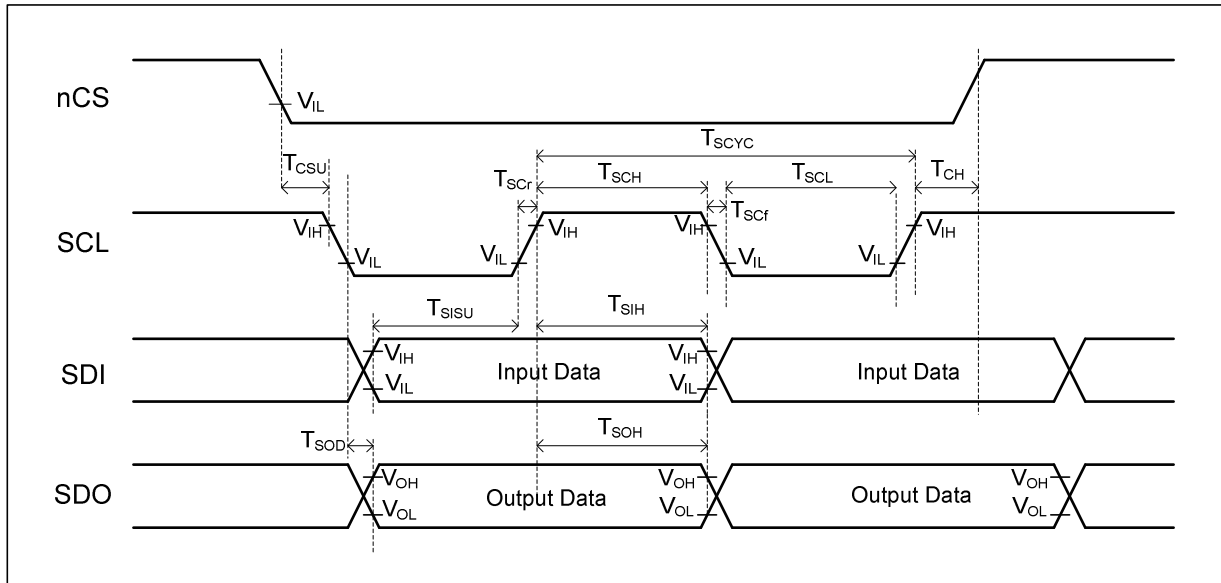

Figure 5 SPI Interface Timing Characteristics

VDDI=1.65 to 3.3V, VDD=2.5 to 3.3V, AGND=DGND=0V, Ta=25 °C

Signal	Symbol	Parameter	Min	Max	Unit	Description
CSX	TCSU	Chip Select Setup Time	TBD		ns	-
	TCH	Chip Select Hold Time	TBD		ns	
SCL	TSCr, TSCf	Serial clock rise/fall time	TBD		ns	
	TSCH	SCL "H" pulse width (Write)	TBD		ns	
	TSCH	SCL "H" pulse width (Read)	TBD		ns	
	TSCYC	Serial clock cycle (Write)	TBD		μs	
	TSCYC	Serial clock cycle (Read)	TBD		μs	
	TSCl	SCL "L" pulse width (Write)	TBD		ns	
	TSCl	SCL "L" pulse width (Read)	TBD		ns	
SDI	TSISU	Serial Input Data Setup Time	TBD		ns	
	TSIH	Serial Input Data Hold Time	TBD		ns	
SDO	TSOD	Serial Output Data Setup Time	TBD		ns	
	TSOH	Serial Output Data Hold Time	TBD	TBD	ns	

Table 6 SPI Interface Characteristics

7.4.4 RGB Interface Characteristics:

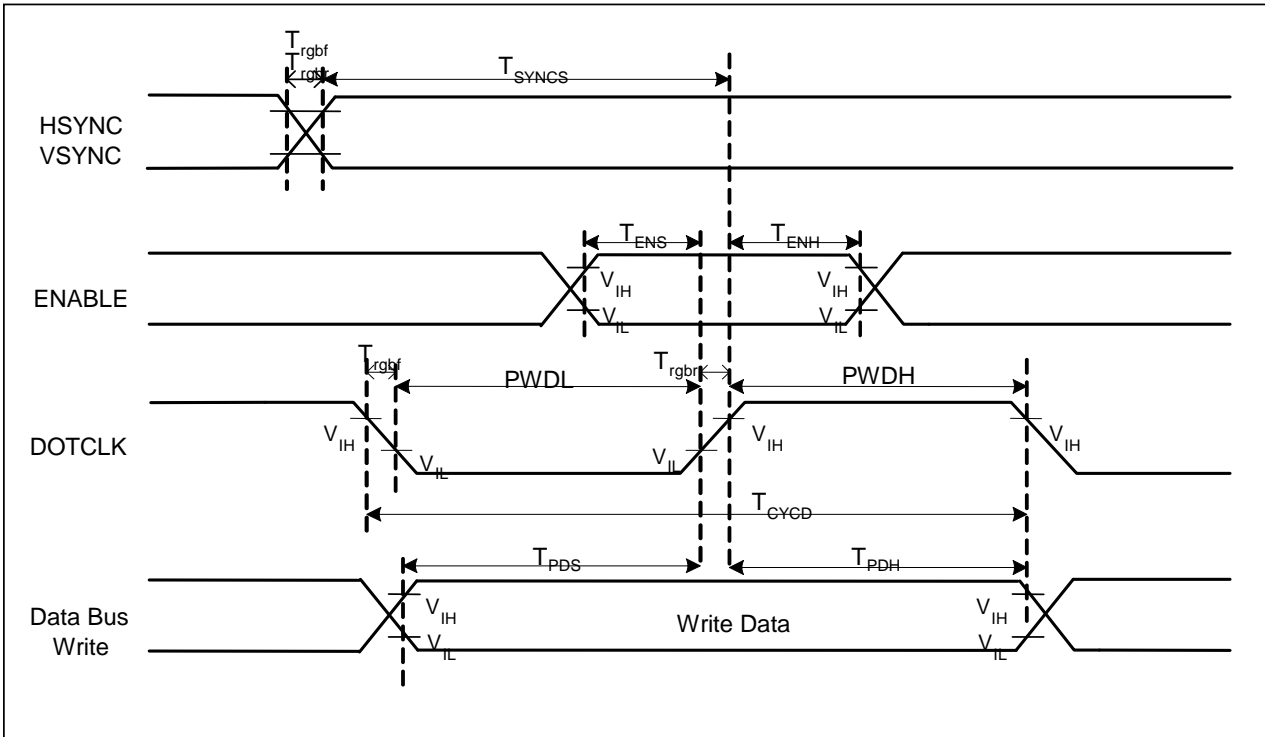

Figure 6 RGB Interface Timing Characteristics

$V_{DD1}=1.65$  to  $3.3V$ ,  $V_{DD}=2.5$  to  $3.3V$ ,  $AGND=DGND=0V$ ,  $T_a=25$  °C

Signal	Symbol	Parameter	MIN	MAX	Unit	Description
HSYNC, VSYNC	TSYNCS	VSYNC, HSYNC Setup Time	TBD		ns	
	Trghr, Trghf	VSYNC, HSYNC Rise/Fall time	TBD		ns	
ENABLE	TENS	Enable Setup Time	TBD		ns	
	TENH	Enable Hold Time	TBD		ns	
DOTCLK	PWDH	DOTCLK High-level Pulse Width	TBD		ns	
	PWDL	DOTCLK Low-level Pulse Width	TBD		ns	
	TCYCD	DOTCLK Cycle Time	TBD		ns	
	Trghr, Trghf	DOTCLK Rise/Fall time	TBD		ns	
DB	TPDS	PD Data Setup Time	TBD		ns	
	TPDH	PD Data Hold Time	TBD		ns	

Table 7 18/16 Bits RGB Interface Timing Characteristics

Signal	Symbol	Parameter	MIN	MAX	Unit	Description
HSYNC, VSYNC	TSYNCS	VSYNC, HSYNC Setup Time	TBD		ns	
	Trghr, Trghf	VSYNC, HSYNC Rise/Fall time	TBD		ns	
ENABLE	TENS	Enable Setup Time	TBD		ns	
	TENH	Enable Hold Time	TBD		ns	
DOTCLK	PWDH	DOTCLK High-level Pulse Width	TBD		ns	
	PWDL	DOTCLK Low-level Pulse Width	TBD		ns	
	TCYCD	DOTCLK Cycle Time	TBD		ns	
	Trghr, Trghf	DOTCLK Rise/Fall time	TBD		ns	
DB	TPDS	PD Data Setup Time	TBD		ns	
	TPDH	PD Data Hold Time	TBD		ns	

Table 8 6 Bits RGB Interface Timing Characteristics

Preliminary

**8 INTERFACE**

8.1.. MCU Interface Type Selection

ST7775R supports 8/16/9/18 bit parallel data bus for 8080 series CPU, 6800 series CPU, RGB serial interfaces. Selection of these interfaces are set by IM[3:0] pins as shown below.

IM3	IM2	IM1	IM0	Interface	Read Back Data Bus Selection
0	0	0	0	6800 MCU16-bit Parallel	DB[17:10], DB[8:1]
0	0	0	1	6800 MCU8-bit Parallel	DB[17:10]
0	0	1	0	8080 MCU16-bit Parallel	DB[17:10], DB[8:1]
0	0	1	1	8080 MCU8-bit Parallel	DB[17:10],
0	1	0	ID	Serial Peripheral Interface(SPI)	SDI, SDO
0	1	1	0	3-wire serial interface	CSX,SCL,SDA
0	1	1	1	4-wire serial interface	CSX,SCL,SDA,DCX
1	0	0	0	6800 MCU18-bit Parallel	DB[17:0]
1	0	0	1	6800 MCU9-bit Parallel	DB[17:9]
1	0	1	0	8080 MCU18-bit Parallel	DB[17:0]
1	0	1	1	8080 MCU9-bit Parallel	DB[17:9]
1	1	--	--	Setting invalid	-

Table 9 Interface Type Selection

Preliminary

8.2.. 8080-Series MCU Write Cycle Sequence

The write cycle means that the host writes information (command / data) to the display via the interface. Each write cycle (WRX high-low-high sequence) consists of 3 control signals (DCX, RDX, WRX) and data signals (DB[17:0]). DCX bit is a control signal, which tells if the data is a command or a data. The data signals are the command if the control signal is low (=‘0’) and vice versa it is data (=‘1’).

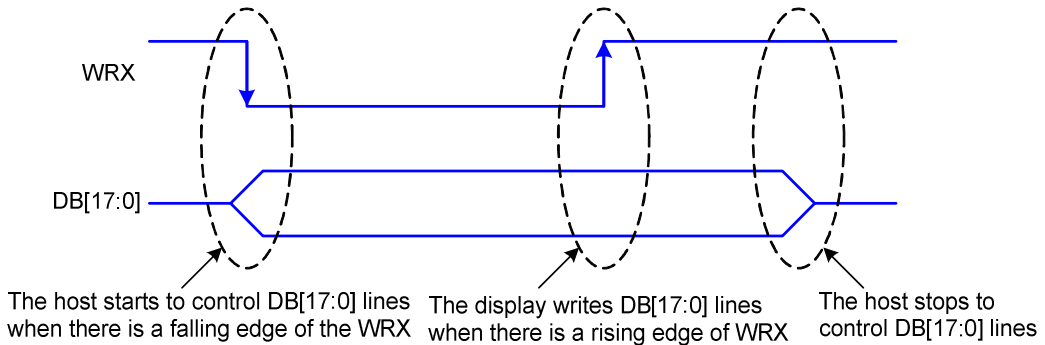

Figure 7 8080-Series WRX Protocol

Note: WRX is an unsynchronized signal (It can be stopped).

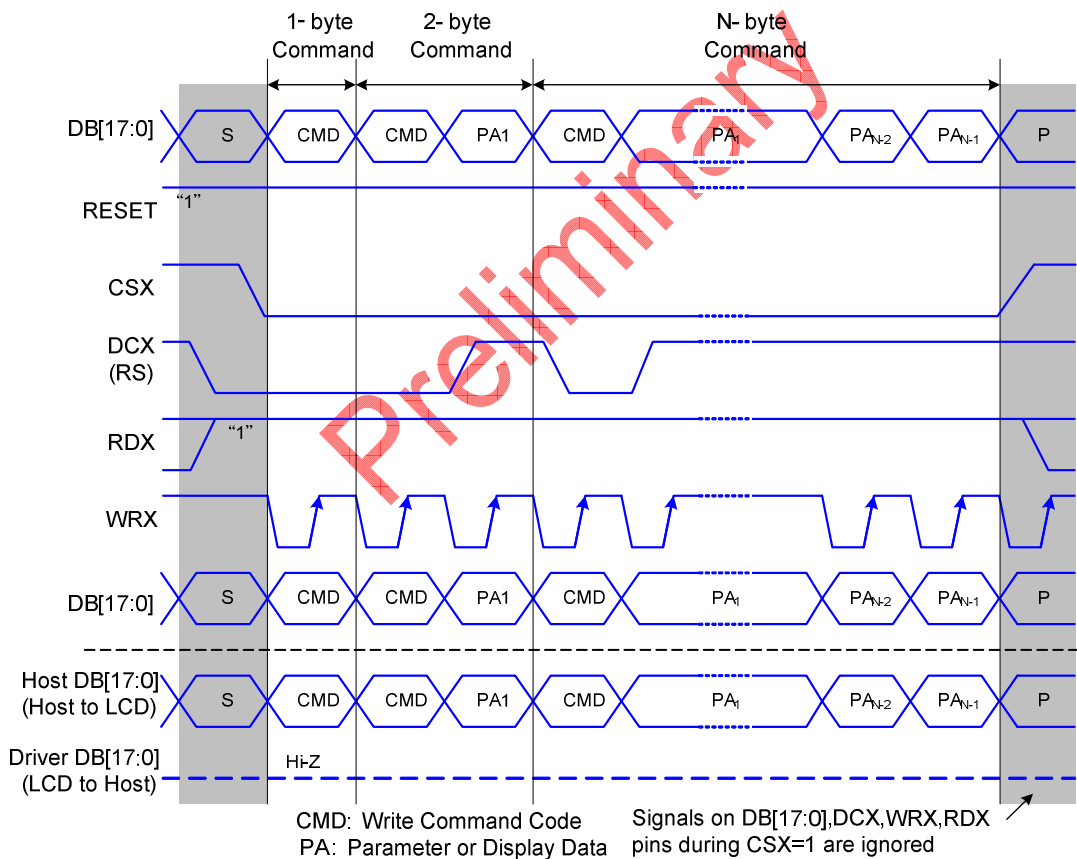

Figure 8 8080-Series Parallel Bus Protocol, Write to Register or Display RAM

### 8.3.. 6800-Series MCU Write Cycle Sequence

The write cycle means that the host writes information (command or/and data) to the display via the interface. Each write cycle (E low-high-low sequence) consists of 3 control signals (DCX, E, R/WX) and data signals (D[17:0]). DCX bit is a control signal, which tells if the data is a command or a data. The data signals are the command if the control signal is low (=‘0’) and vice versa it is data (=‘1’).

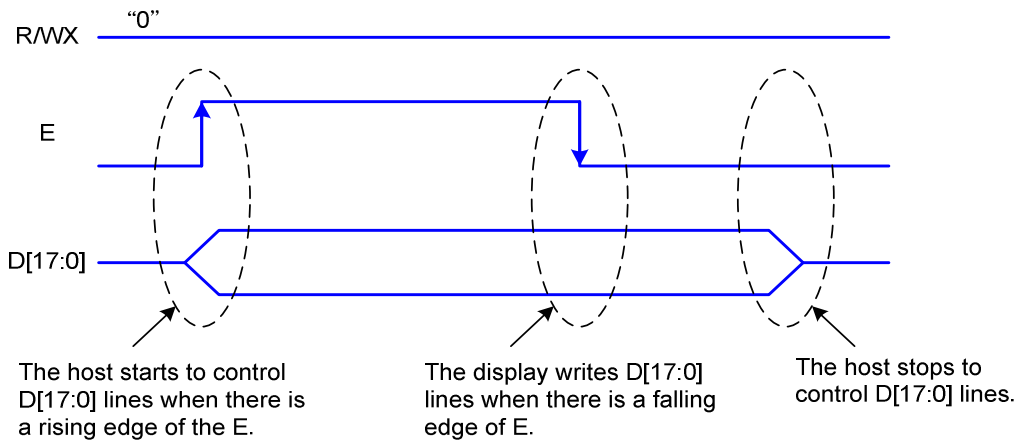

Figure 9 6800-Series WRX Protocol

Note: E is an unsynchronized signal (It can be stopped)

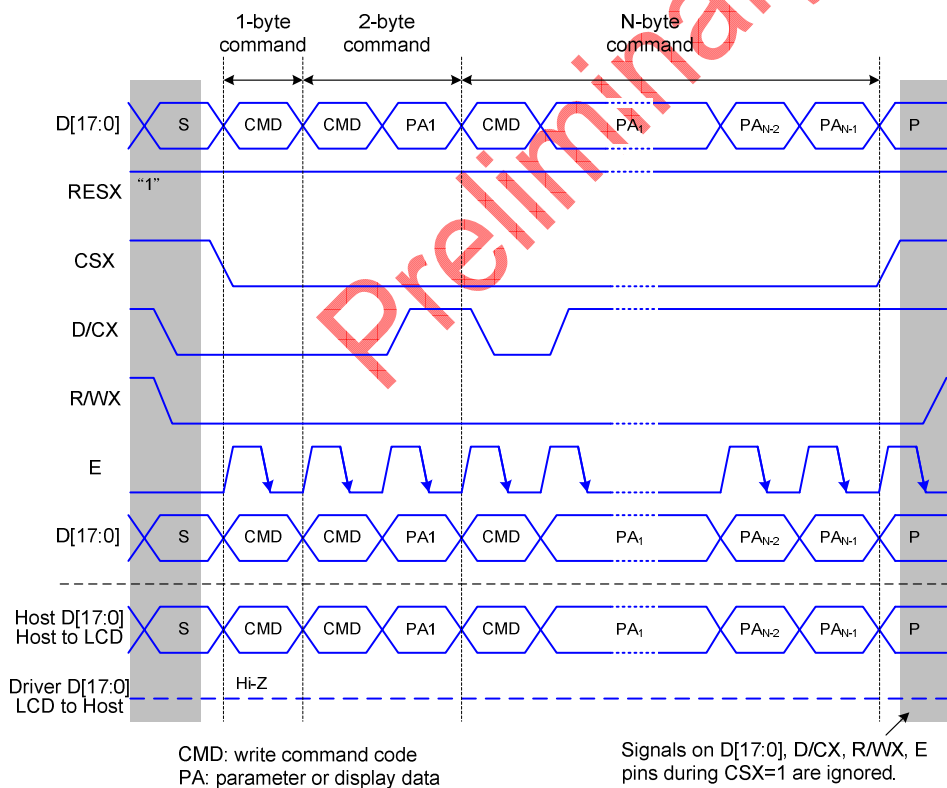

Figure 10 6800-Series Parallel Bus Protocol, Write to Register or Display RAM

8.3.1 18 bits Interface Write Data Format

The 8080-18bits interface is selected by setting the IM [3:0] = "1010". The 6800-18bits interface is selected by setting the IM [3:0] = "1000". The 18 bits mode only 262k colors format in display. In this interface write instructions and DRAM method following figure.

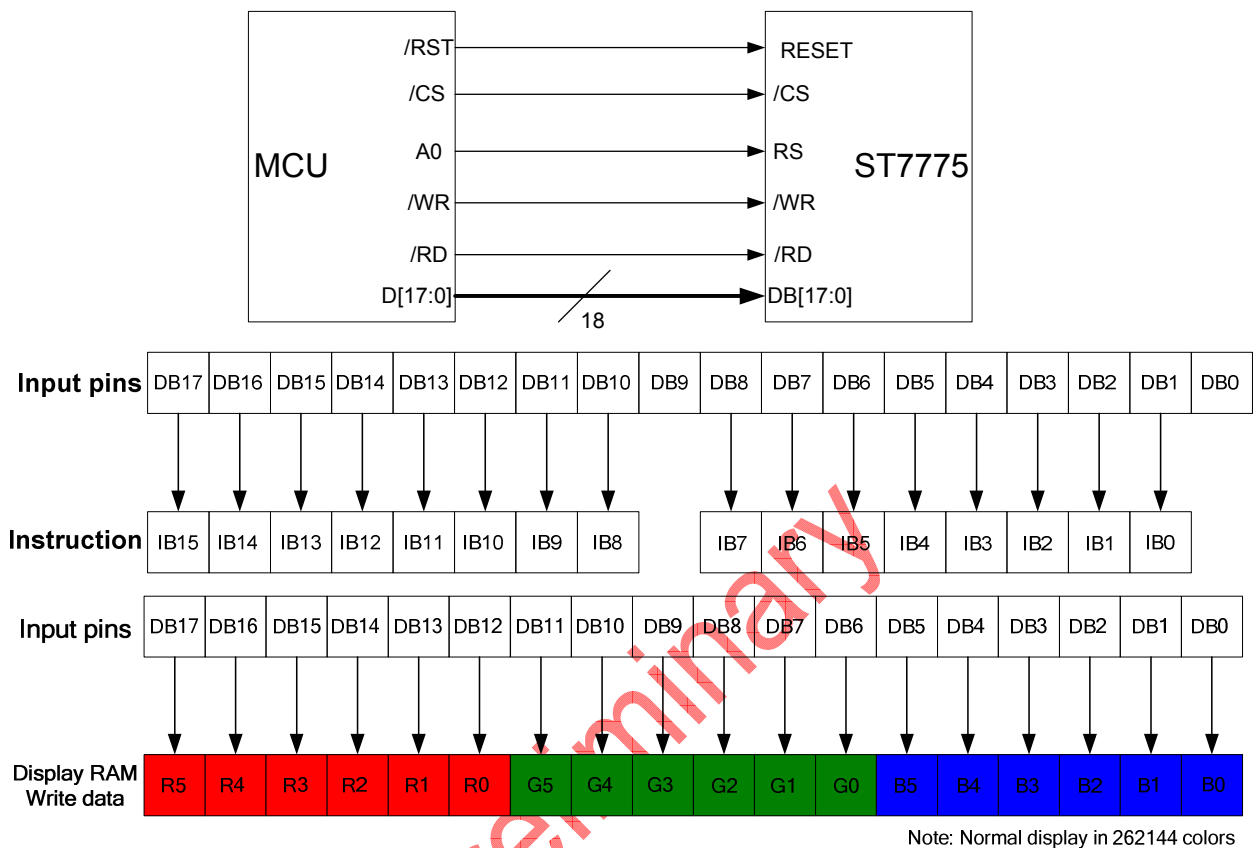
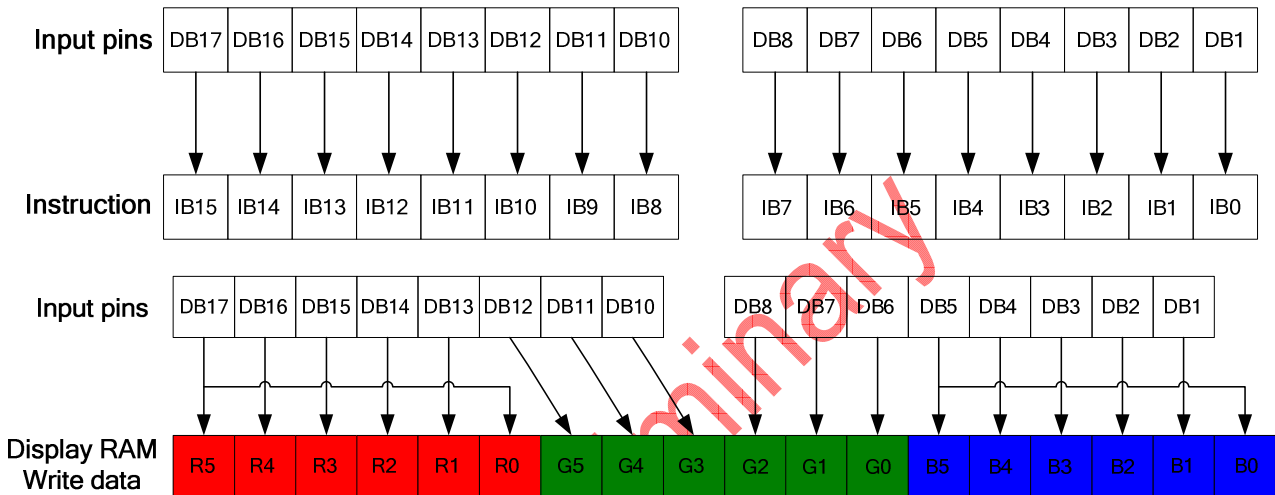
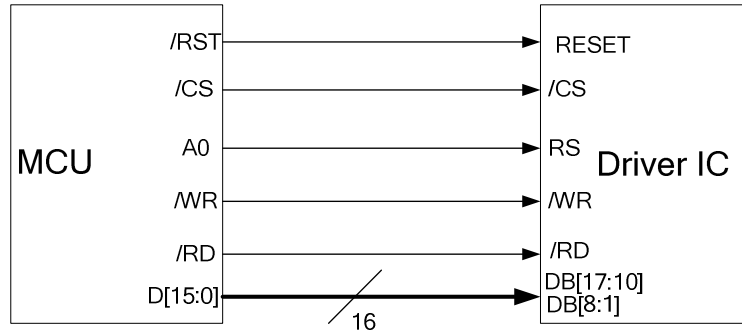

Figure 11 18 bits Interface Data Format (Command Write/DRAM Write)

8.3.2 16 bits Interface Write Data Format

The 8080-16bits interface is selected by setting IM [3:0] = "0010". The 6800-16bits interface is selected by setting IM [3:0] = "0000". The mode can display 262k or 65k colors format. When the 262k color format is display, two transfers mode is used (first transfer: 2 bits, second transfer: 16 bits or first transfer: 16 bits, second transfer: 2 bits).



Note: Normal display in 65K colors (MDT[1:0]="00")

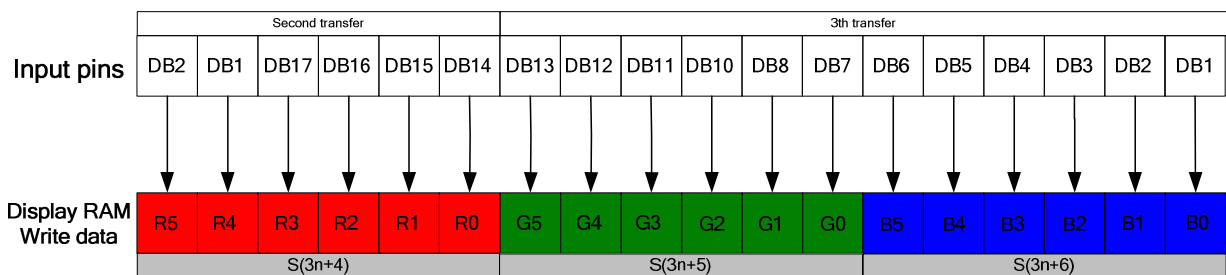
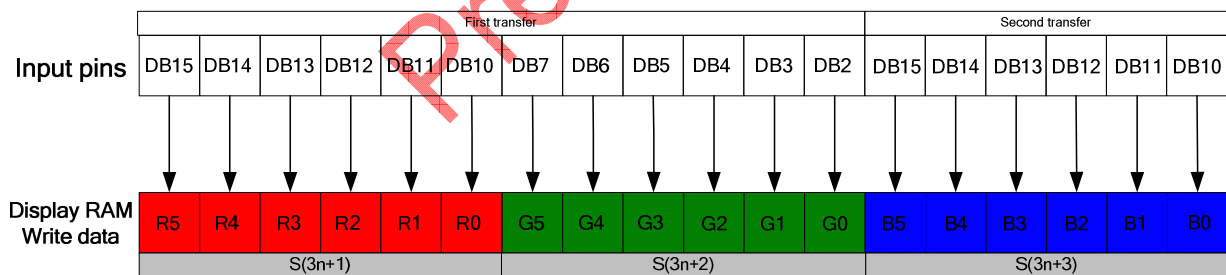

Note: Normal display in 262144 colors (MDT[1:0] = "01")



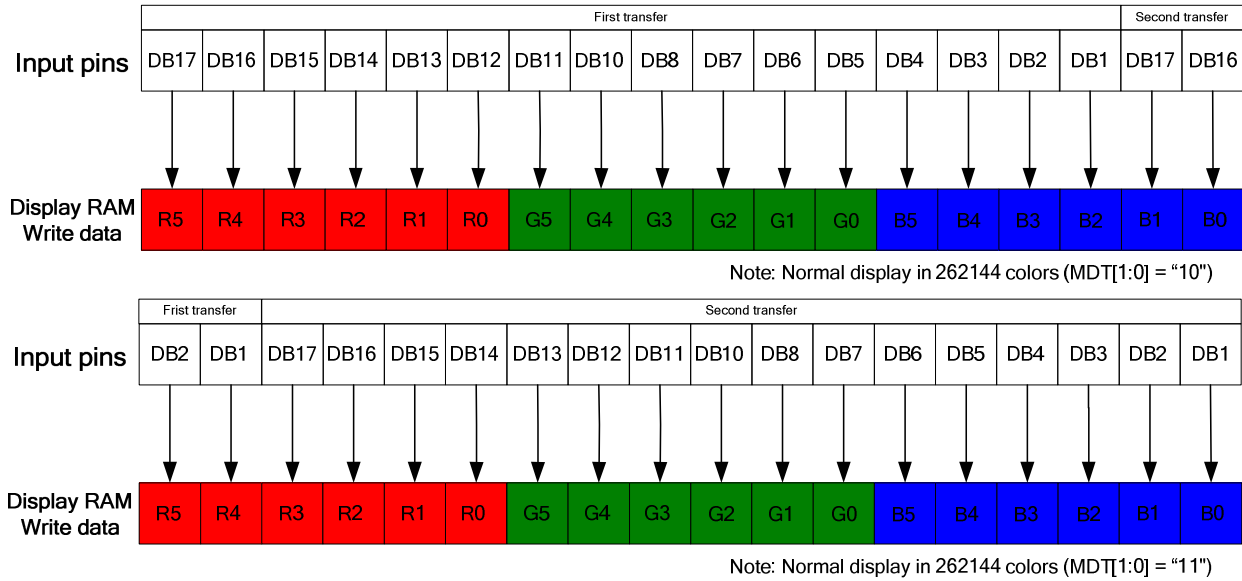
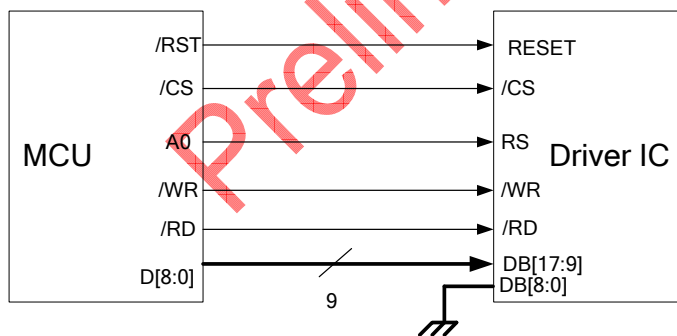

Figure 12 16 bits Interface Data Format (Command Write/Display RAM Write)

### 8.3.3 9 bits Interface Write Data Format

The 8080-9bits interface is selected by setting the IM [3:0] = "1011". The 6800-9bits interface is selected by setting the IM [3:0] = "1001" and the DB [17:9] pins are used to transfer the data. When writing the 16-bit register, the data is divided into upper byte and lower byte and the upper byte is transferred first. The display data is also divided in upper byte (9 bits) and lower byte, and the upper byte is transferred first. The unused DB [8:0] pins must be tied to either VDDI or DGND.



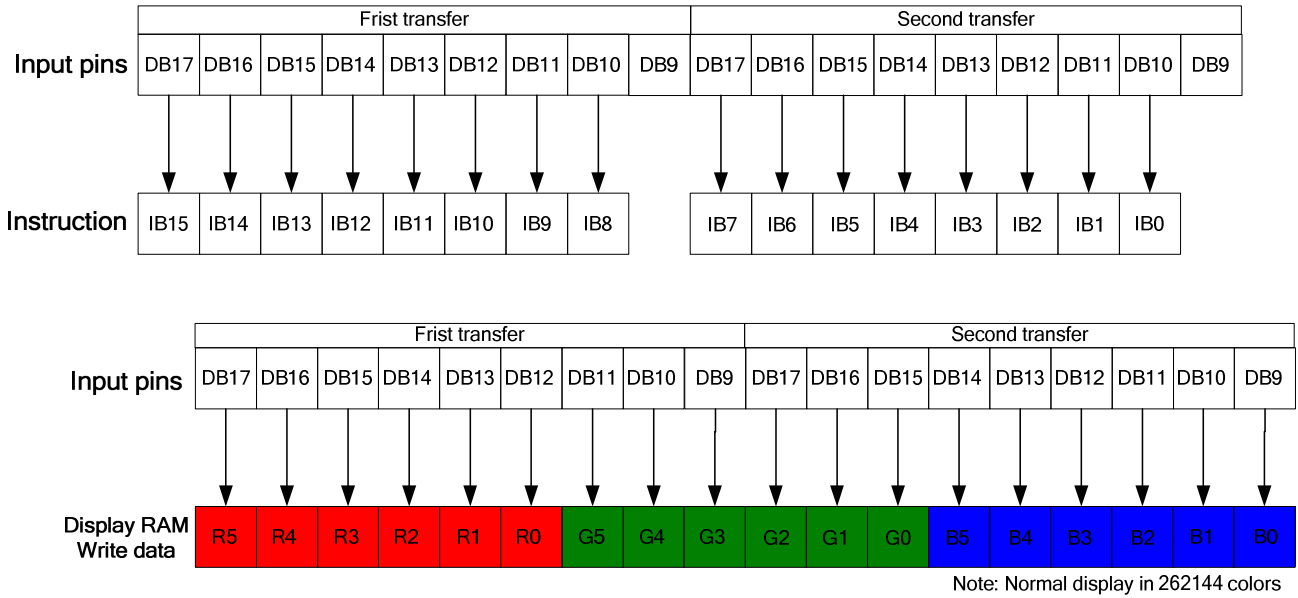
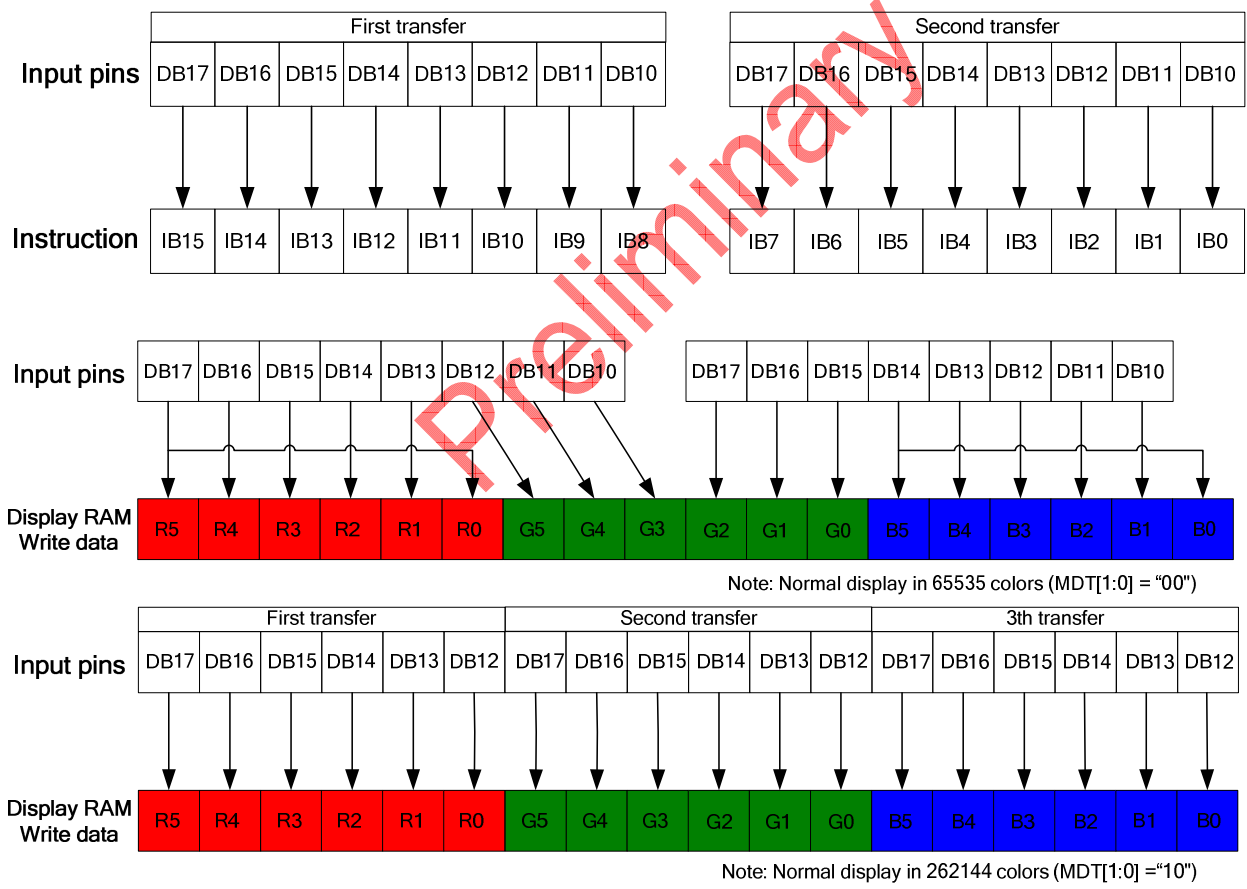
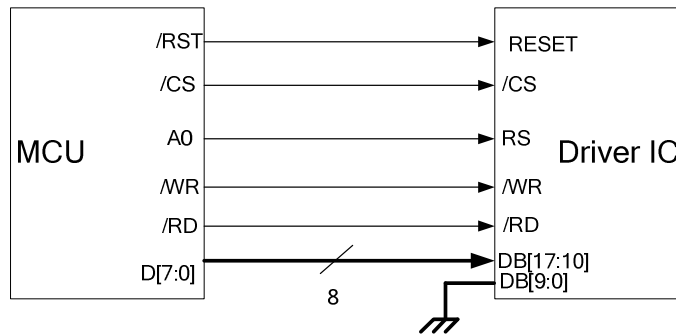

Figure 13 9 bits Interface Data Format (Command Write/Display RAM Write)

Preliminary

8.3.4 8 bits Interface Write Data Format

The 8080 8-bit interface is selected by setting the IM [3:0] as "0011". The 6800 8-bit interface is selected by setting the IM [3:0] as "0001" and the DB [17:10] pins are used to transfer the data. The mode can display 262k or 65k colors format. When writing the 16-bit register, the data is divided into upper byte lower byte and the upper byte is transferred first. The display data is also divided in upper byte (8 bits) and lower byte, and the upper byte is transferred first. The written data is expanded into 18 bits internally (see the figure below) and then written into DRAM. The unused DB [9:0] pins must be tied to either VDDI or DGND.



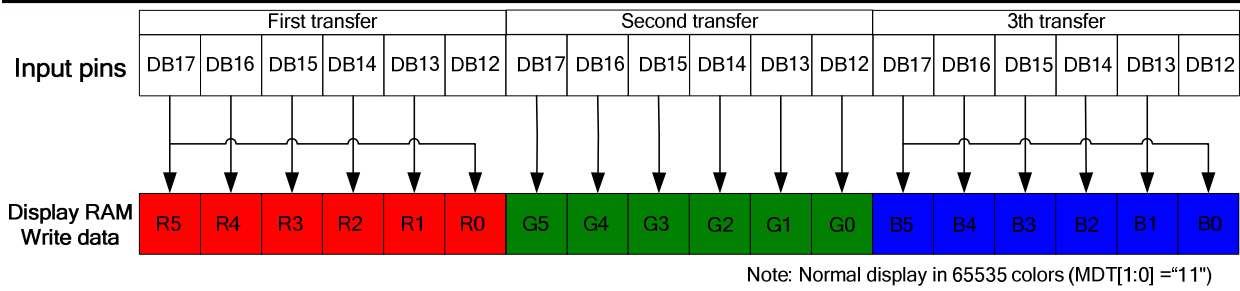

Figure 14 8 bits interface data format (command write/Display RAM write)

Preliminary

8.3.5 8080-series MCU Read Cycle Sequence

The read cycle (RDX “1”- “0”- “1” sequence) means that the host reads information from display via interface. The driver sends data (DB [17:0]) to the host when there is a falling edge of RDX and the host reads data when there is a rising edge of RDX.

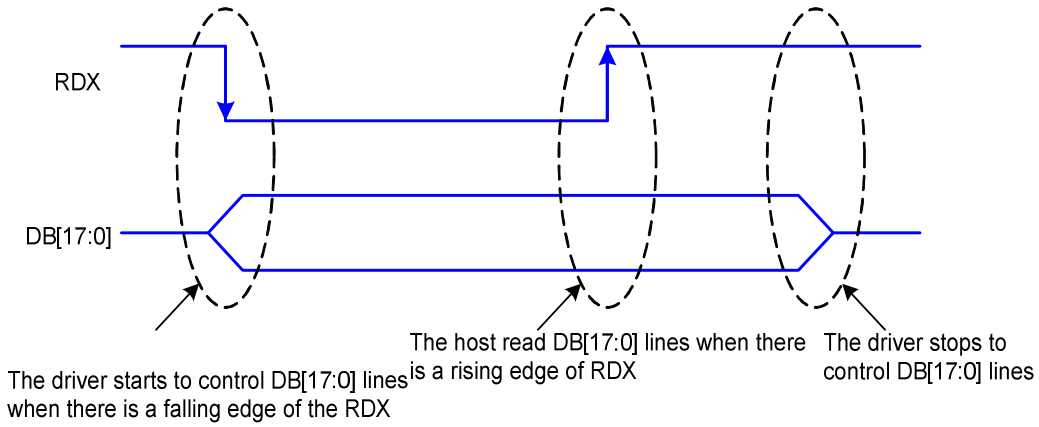

Figure 15 8080-Series Read Protocol

Note1: RDX is an unsynchronized signal (It can be stopped)

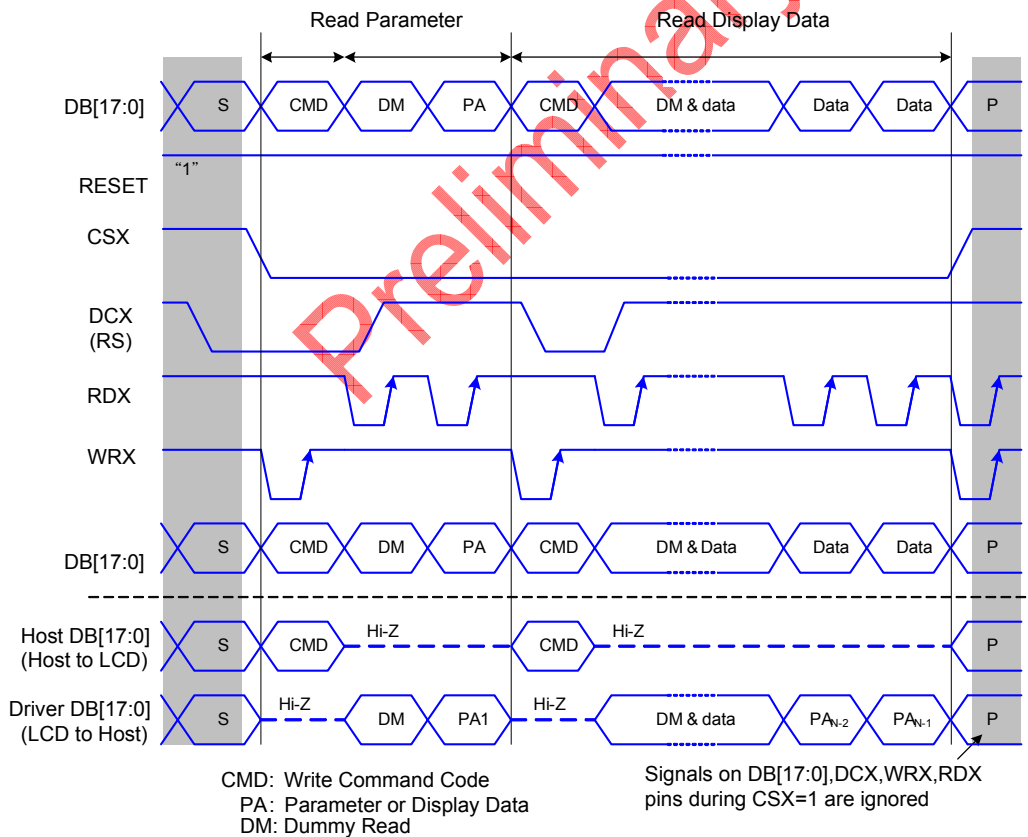

Figure 16 8080-series parallel bus protocol, read data from register or display RAM

8.3.6 6800-series MCU Read Cycle Sequence

The read cycle (E low-high-low sequence) means that the host reads information from LCD driver via interface. The driver sends data (DB [17:0]) to the host when there is a rising edge of E and the host reads data when there is a falling edge of E.

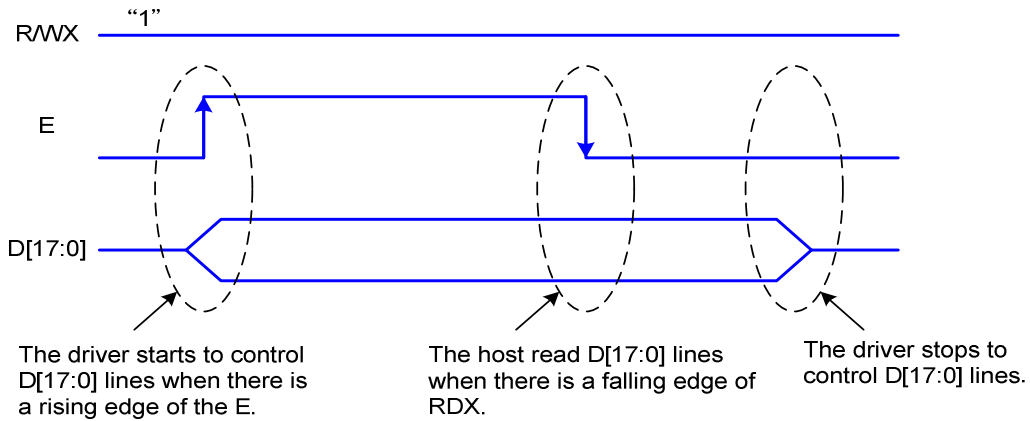

Figure 17 6800-Series Read Protocol

Note: E is an unsynchronized signal (It can be stopped)

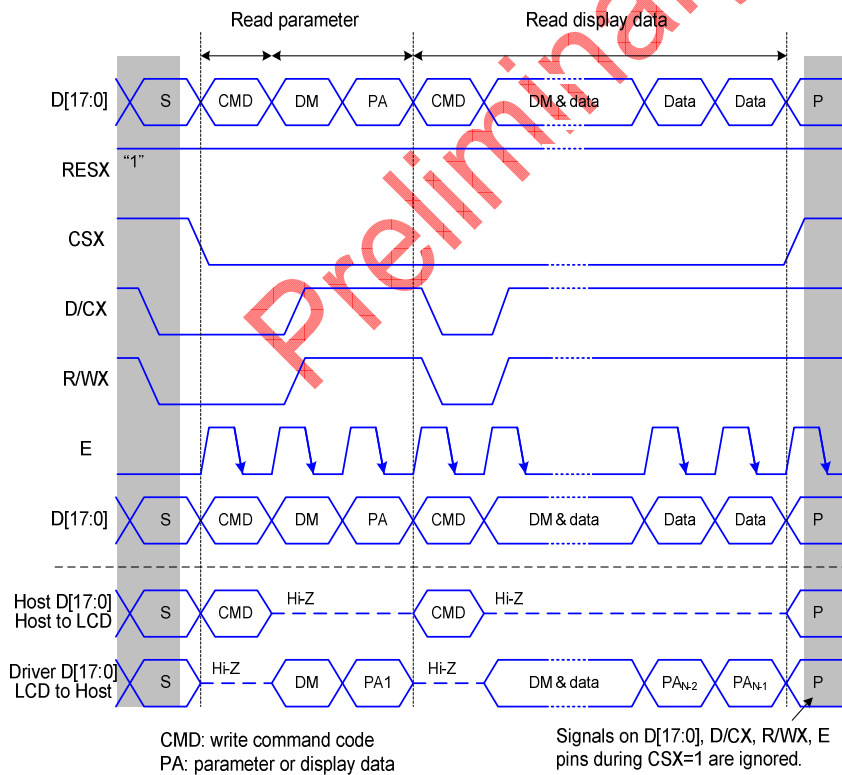

Figure 18 6800-series parallel bus protocol, read data from register or display RAM

8.3.7 18bits interface read data format

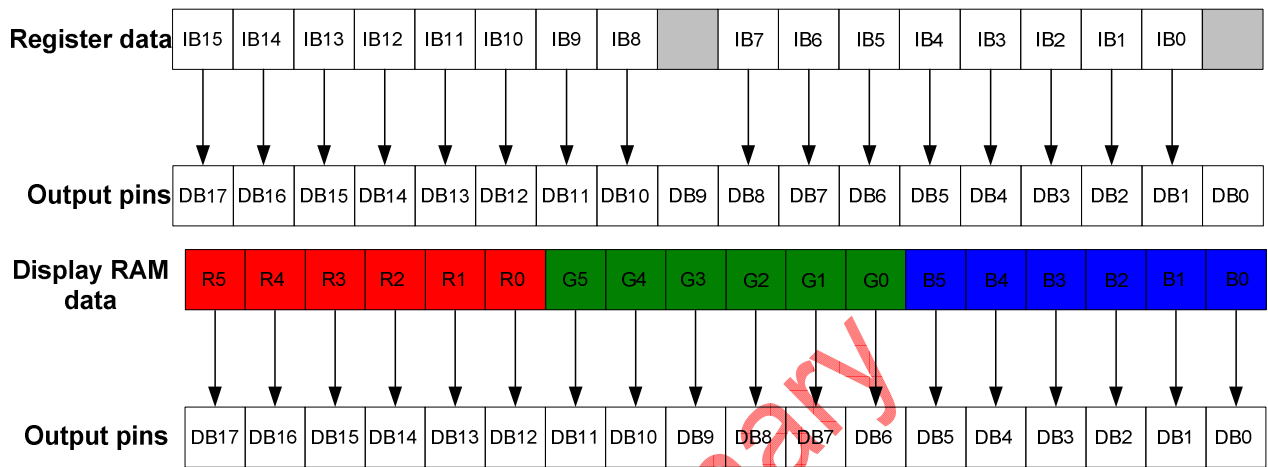
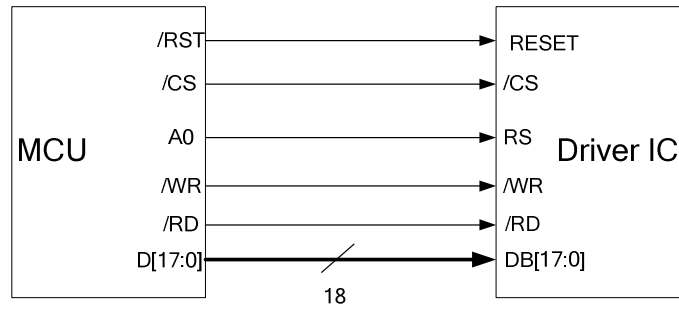

Figure 19 18 bits Interface Data Format (Command Read/Display RAM Read)

Preliminary

8.3.8 16bits Interface Read Data Format

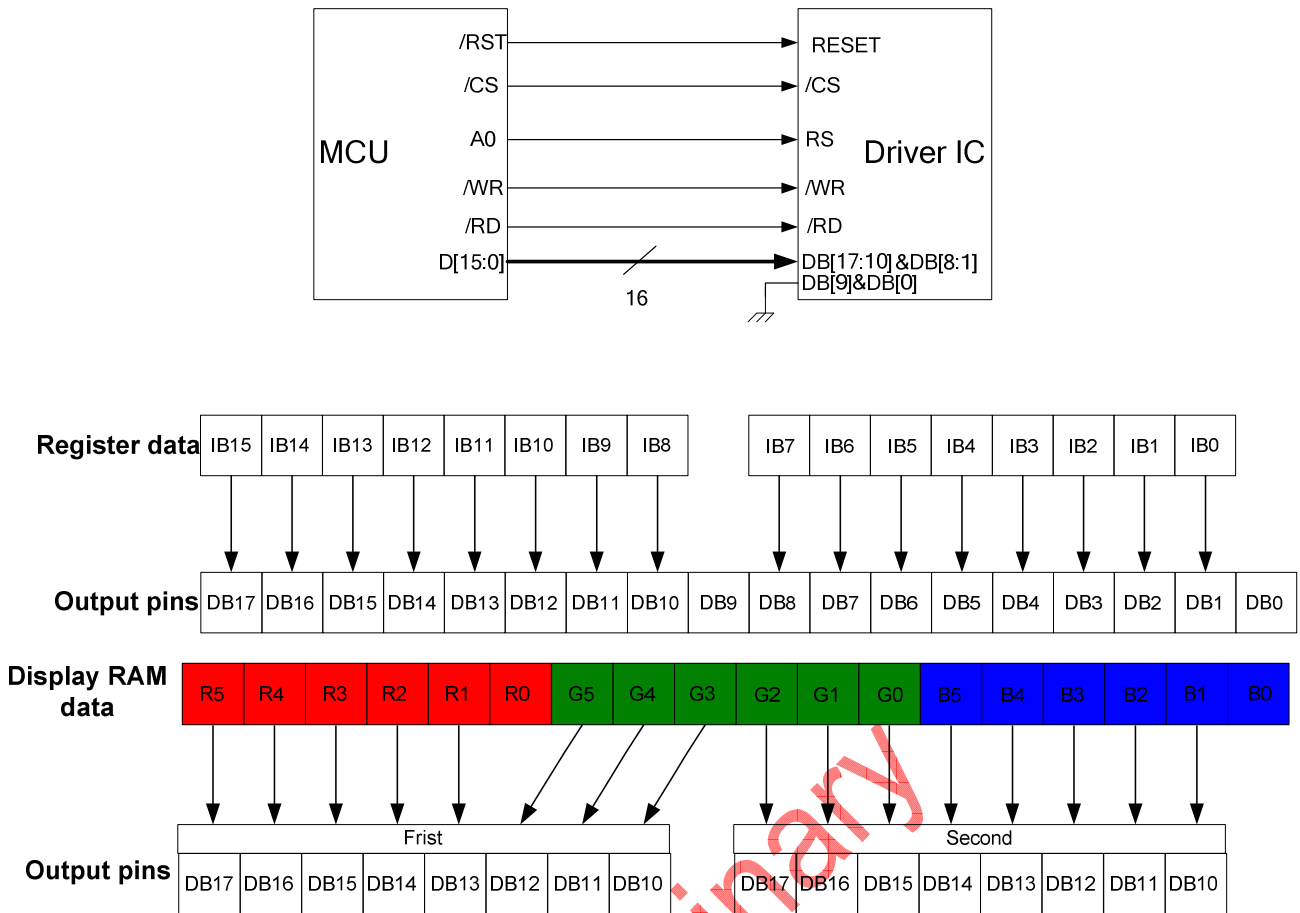

Figure 20 16 bits Interface Data Format (Command Read/Display RAM Read)

Preliminary



8.3.9 9bits Interface Read Data Format

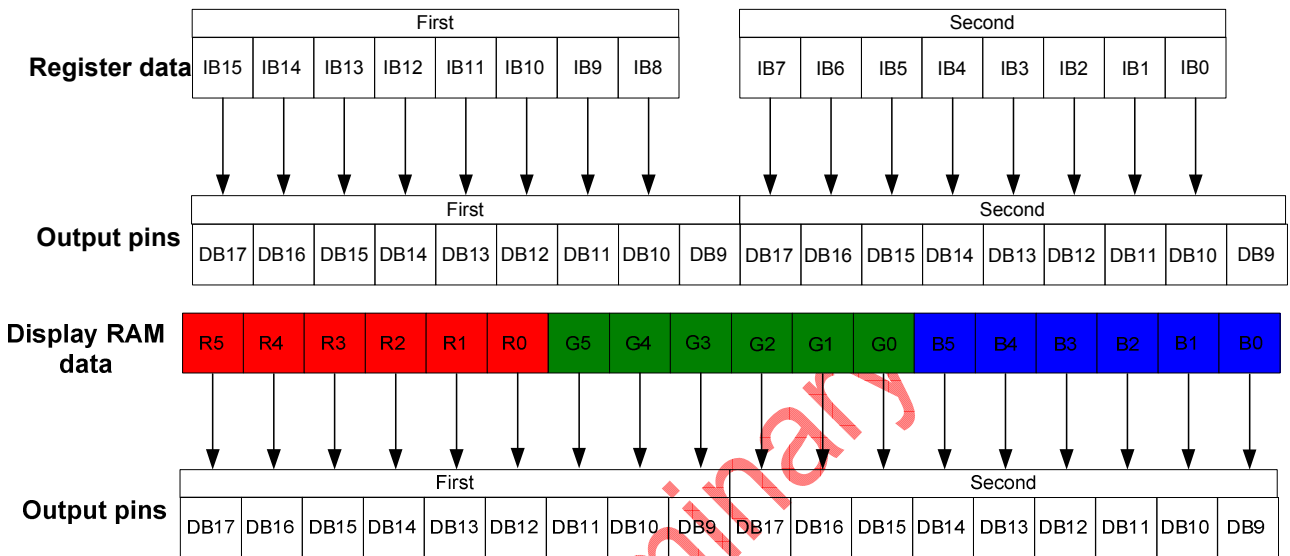
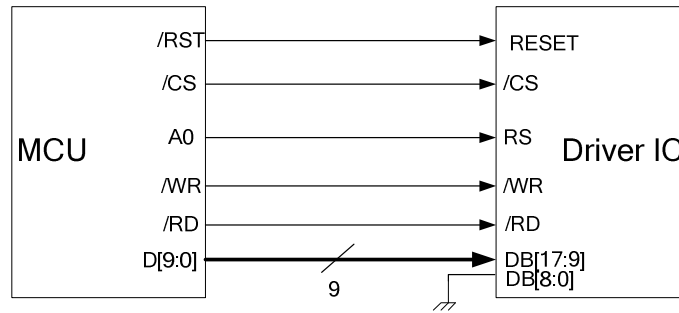

Figure 21 9 bits Interface Data Format (Command Read/Display RAM Read)

Preliminary

8.3.10 8bits Interface Read Data Format

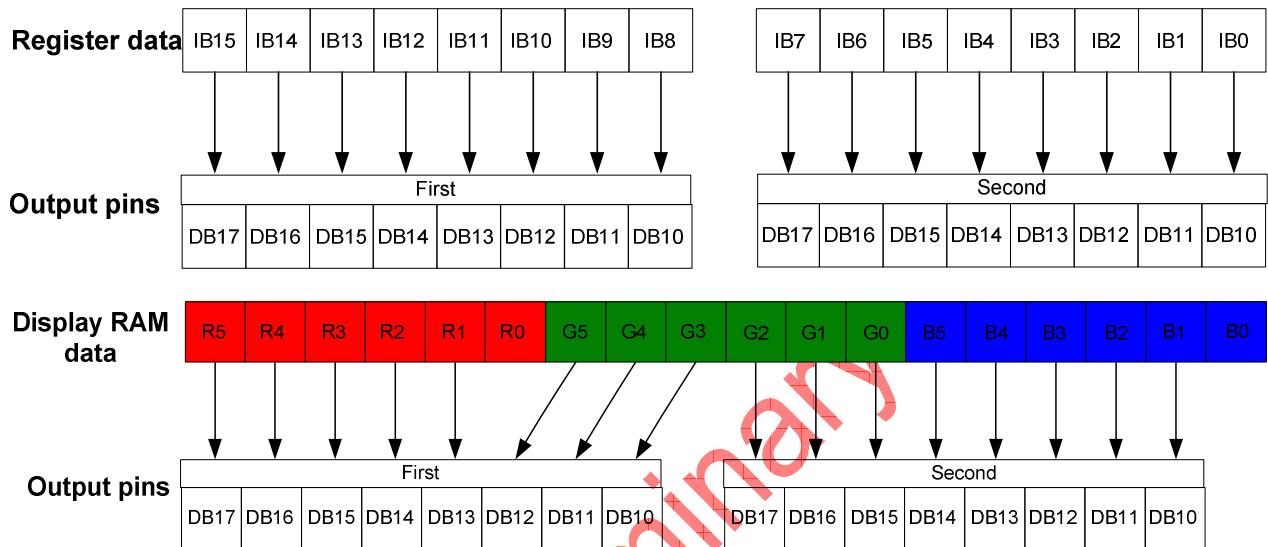
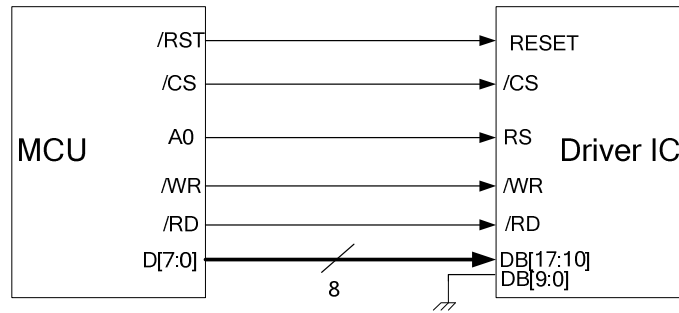

Figure 22 8 bits Interface Data Format (Command Read/Display RAM Read)

Preliminary

GS = '1'	GS = '0'	SS = '0'	S1	S2	S3	S4	S5	S6	-----	S523	S524	S525	S526	S527	S528
		SS = '1'	S526	S527	S528	S523	S524	S525	-----	S4	S5	S6	S1	S2	S3
		BGR='0'	R	G	B	R	G	B	-----	R	G	B	R	G	B
		BGR='1'	B	G	R	B	G	R		B	G	R	B	G	R
G220	G1	X Address	"0000" h			"0001" h			-----	"00AE" h			"00AF" h		
		Y Address	"0000" h			"0000" h			-----	"0000" h			"0000" h		
G219	G2	X Address	"0000" h			"0001" h			-----	"00AE" h			"00AF" h		
		Y Address	"0001" h			"0001" h			-----	"0001" h			"0001" h		
—	—							-----							
—	—							-----							
—	—							-----							
—	—							-----							
G2	G219	X Address	"0000" h			"0001" h			-----	"00AE" h			"00AF" h		
		Y Address	"00DA" h			"00DA" h			-----	"00DA" h			"00DA" h		
G1	G220	X Address	"0000" h			"0001" h			-----	"00AE" h			"00AF" h		
		Y Address	"00DB" h			"00DB" h			-----	"00DB" h			"00DB" h		

Figure 23 DRAM Address Map Table

Note:

X Address End Instruction : R36h

X Address Start Instruction : R37h

Y Address End Instruction : R38h

Y Address Start Instruction : R39h

SS/GS ,RGB Setting Instruction : R03h

Preliminary

8.4.. RGB Input Interface

The RGB Interface mode for ST7775R is selected by setting the RIM[1:0] bits as following table.

RIM1	RIM0	RGB Interface Mode	Data pins
0	0	18-bit RGB Interface	DB[17:0]
0	1	16-bit RGB Interface	DB[17:13], DB[11:1]
1	0	6-bit RGB Interface	DB[17:12]
1	1	Setting prohibited	

18-bit RGB Interface ( 262K colors )

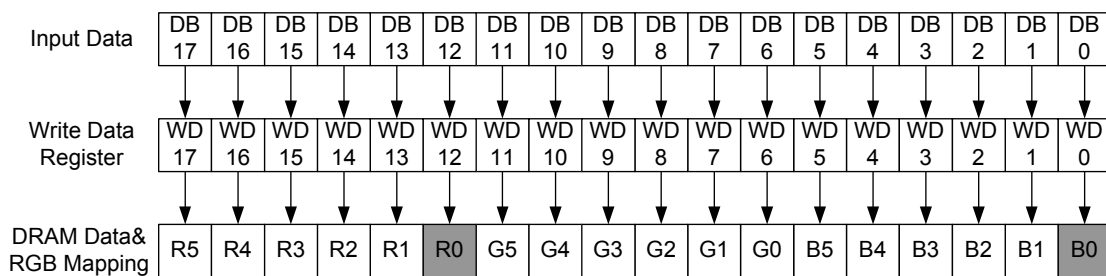

16-bit RGB Interface ( 65K colors )

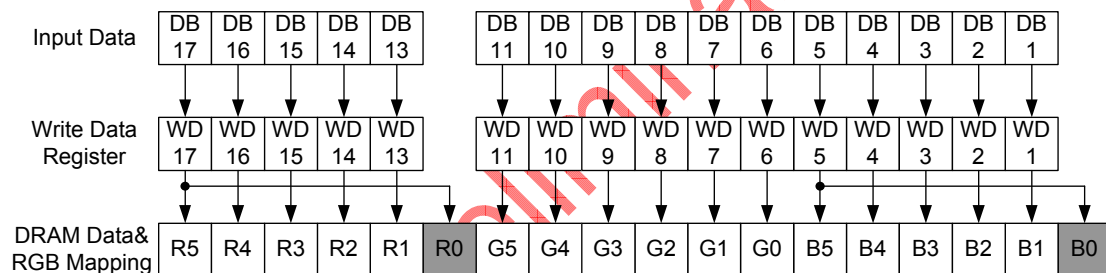

6-bit RGB Interface ( 262K colors )

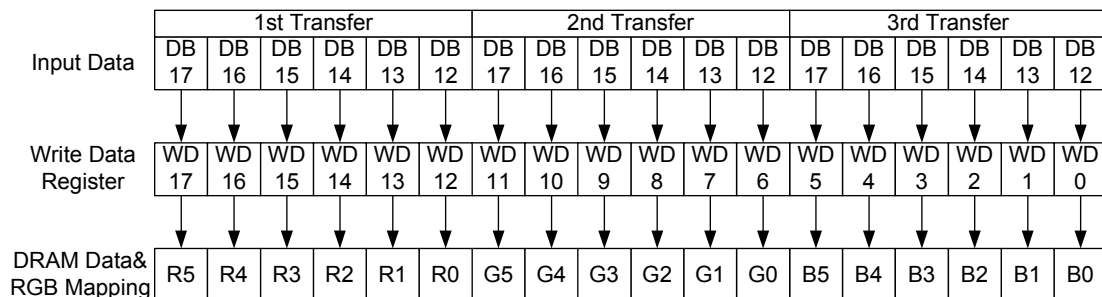

Figure 24 RGB Interface Data Format

8.4.1 RGB Interface

The display operation via the RGB interface is synchronized with the VSYNC, HSYNC, and DOTCLK signals. The data can be written only within the specified area with low power consumption by using window address function and high-speed write mode (HWM = 1). The back porch and front porch are used to set the RGB interface timing.

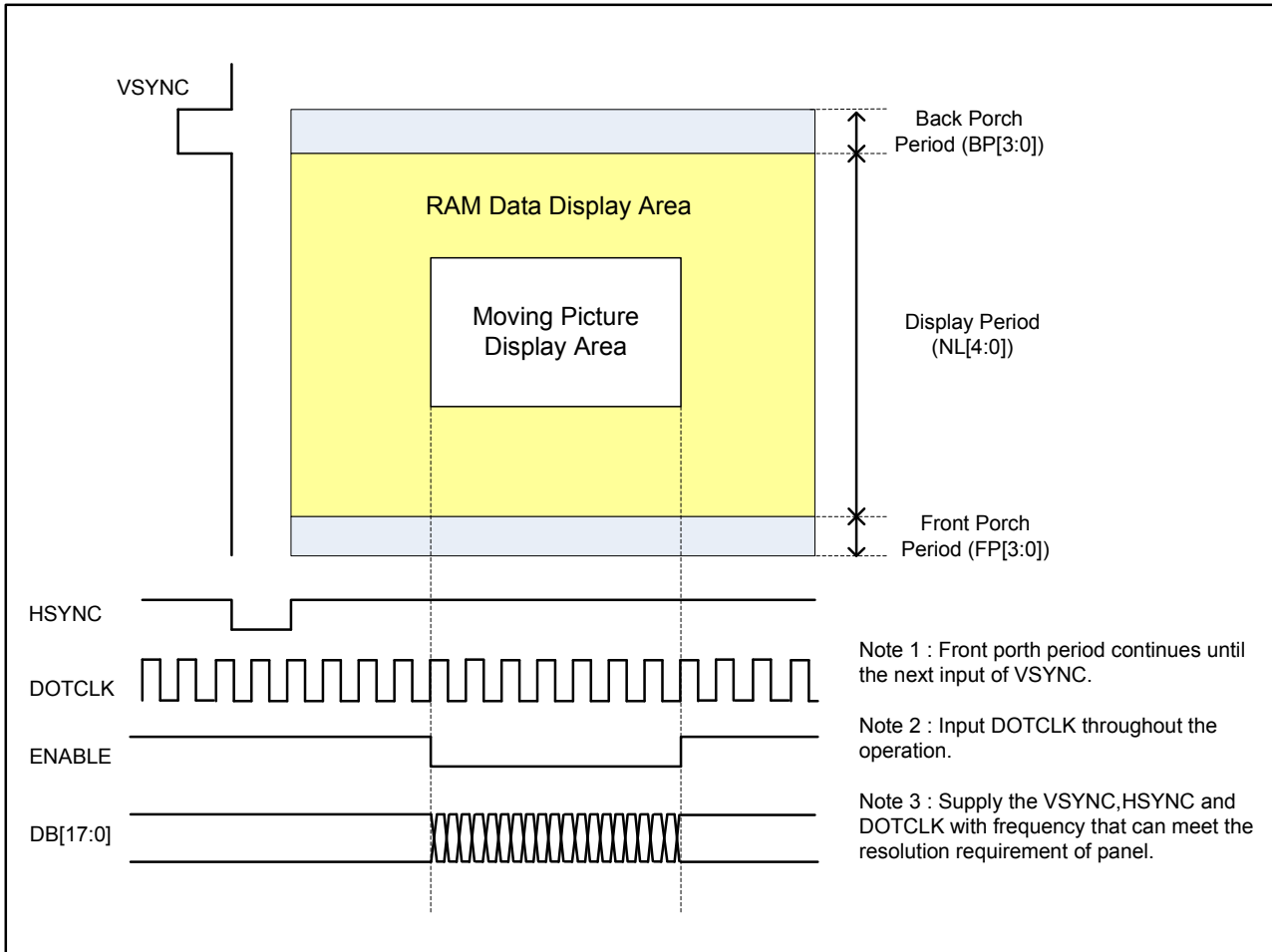

Figure 25 DRAM Access Area by RGB Interface

8.4.2 RGB Interface Timing

The timing chart of 18-/16-bit RGB interface mode is shown as follows.

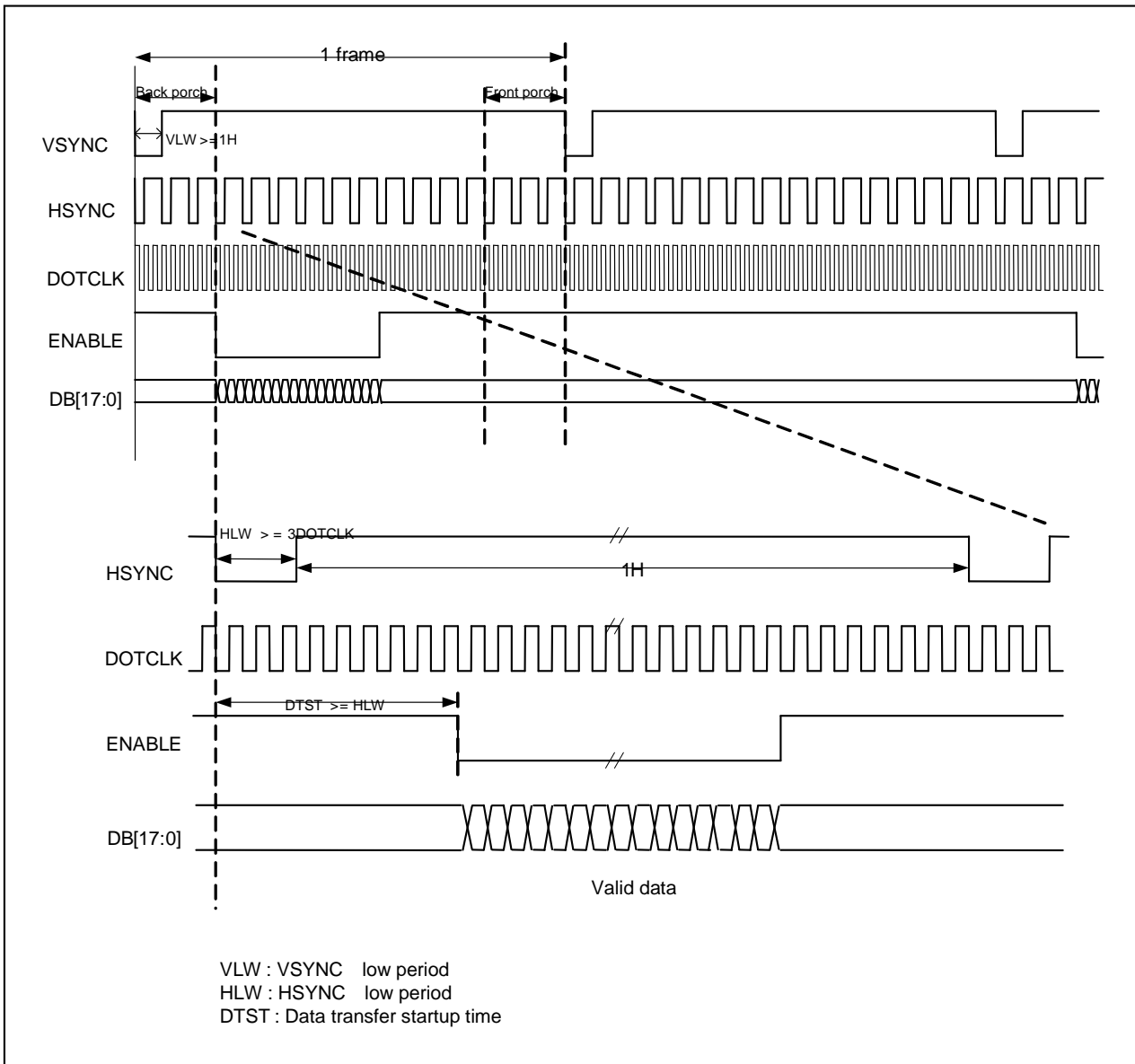

Figure 26 Timing Chart of Signals in 18-/16-bit RGB Interface Mode

The timing chart of 6-bit RGB interface mode is shown as follows.

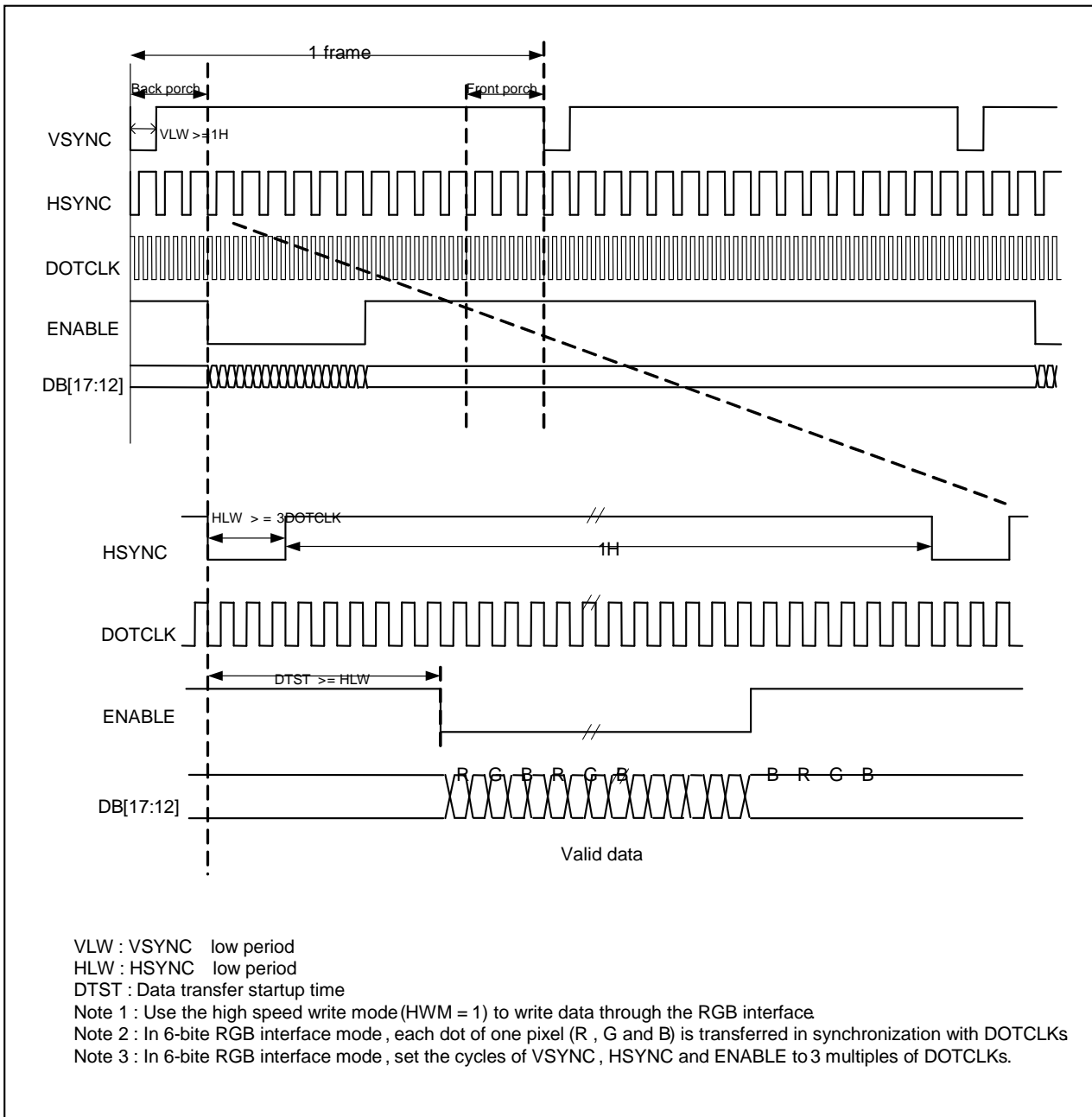

Figure 27 Timing chart of signals in 6-bit RGB interface mode

### 8.4.3 Moving Picture Mode

ST7775R has the RGB interface to display moving picture and incorporates DRAM to store display data, which has following merits in displaying a moving picture.

- The window address function defined the update area of DRAM.
- The DRAM is updated only the moving picture area.
- It can contribute to lower the power consumption of the system by reducing data transfer.
- When display the moving picture in RGB interface mode, the DB[17:0] can be switched as system interface to update still picture area and registers, such as icons.

#### RAM access via a system interface in RGB-I/F mode

ST7775R allows DRAM access via the system interface in RGB interface mode. In RGB interface mode, data are written to the internal DRAM in synchronization with DOTCLK while ENABLE signal is "Low". When write data to the internal DRAM by the system interface, set ENABLE("High") to stop write data via RGB interface. Then set RM = "0" to enable RAM access via system interface. When restart RAM access in RGB interface mode, wait one read/write cycle, set RM = "1" and then the index register (R22h) to start accessing RAM via the RGB interface. If RAM accesses via two interfaces conflicts, there is no guarantee that data are written to the internal DRAM.

The following figure illustrates the operation of the ST7775R when displaying a moving picture via the RGB interface and rewriting the still picture RAM area via the system interface.

Preliminary



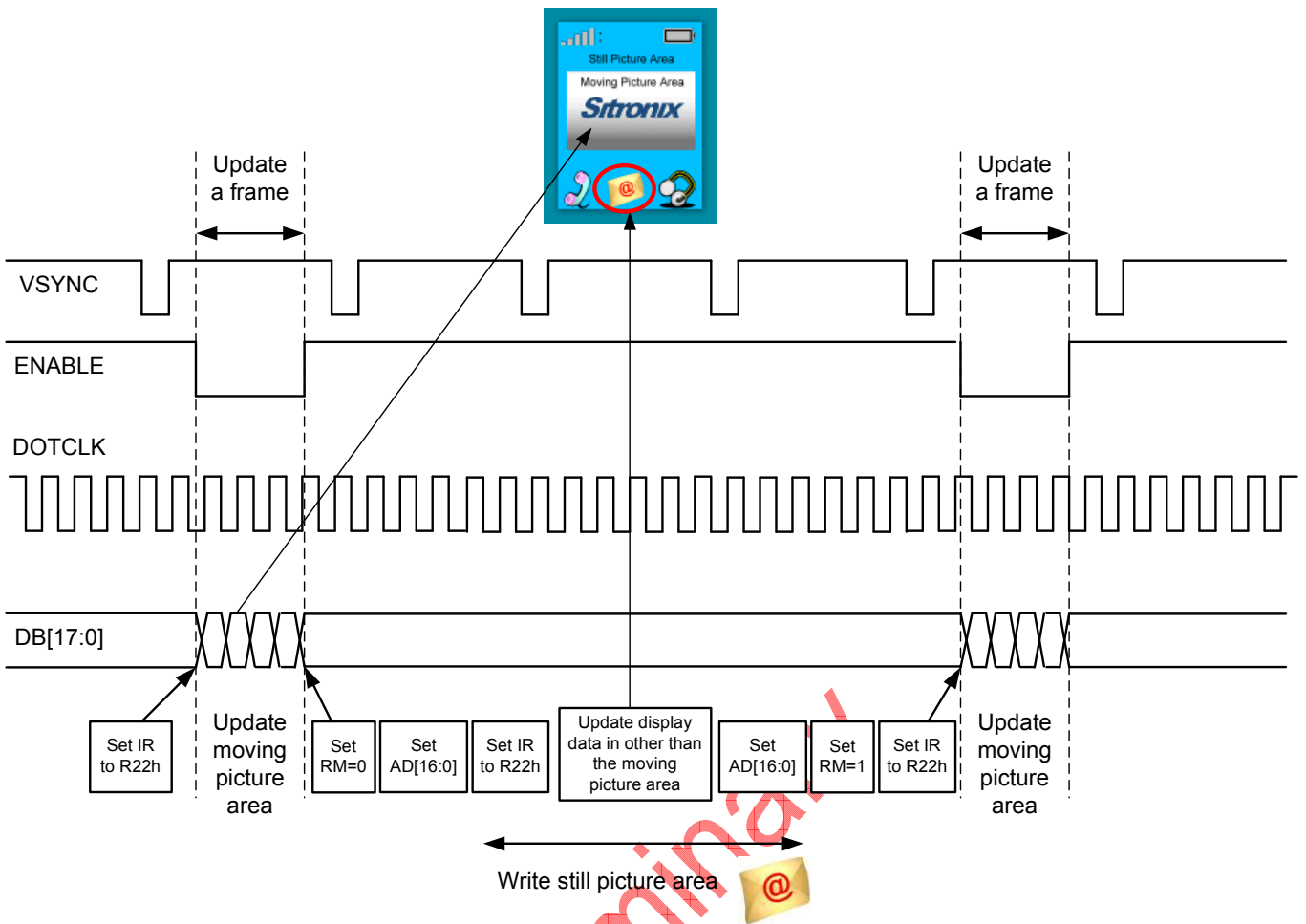

Figure 28 Example of update the still and moving picture

8.4.4 6-bit RGB Interface

The 6-bit RGB interface is selected by setting the RIM[1:0] bits to "10". The display operation is synchronized with VSYNC, HSYNC, and DOTCLK signals. Display data are transferred to the internal DRAM in synchronization with the display operation via 6-bit RGB data bus (DB[17:12]) according to the data enable signal (ENABLE). Unused pins (DB[11:0]) must be fixed at GND level. Registers can be set by the system interface (i80/SPI).

RGB Interface With 6-bit Data Bus (RIM=10)

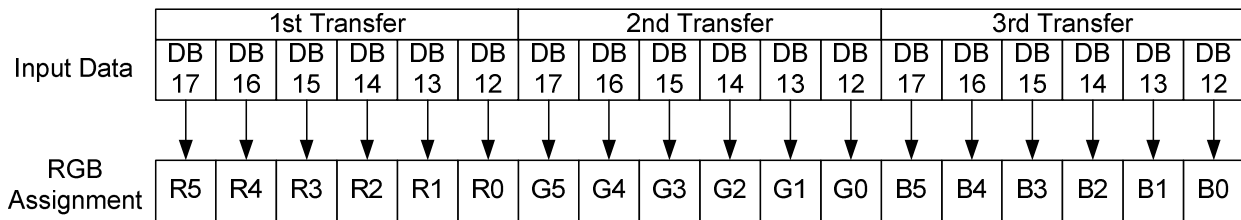

Figure 29 Example of 6-bit RGB interface data format

Data transfer synchronization in 6-bit RGB interface mode

ST7775R has counters to count the first, second, third 6 bit transfers via 6-bit RGB interface. The transfer counters are always reset to first data on the falling edge of VSYNC from the next frame period. If a mismatch data transfer occurs, the correct data transfer will be restart via 6 bit interface in next frame period. When data transfer is consecutively in moving picture operation, this function can help the display system restoring normal display operation and minimizes effects in occurring mismatch data transfer.

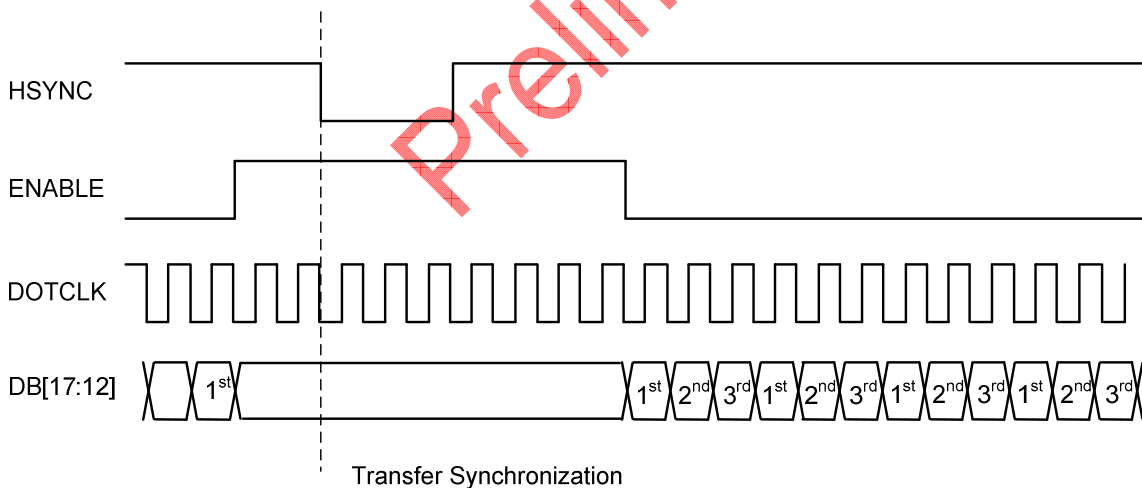

Figure 30 6-bit Transfer Synchronization

8.4.5 16-bit RGB Interface

The 16-bit RGB interface is selected by setting the RIM[1:0] bits to “01”. The display operation is synchronized with VSYNC, HSYNC, and DOTCLK signals. Display data are transferred to the internal RAM in synchronization with the display operation via 16-bit RGB data bus (DB[17:13], DB[11:1]) according to the data enable signal (ENABLE). Registers are set only via the system interface.

16-bit RGB Interface ( 65K colors )

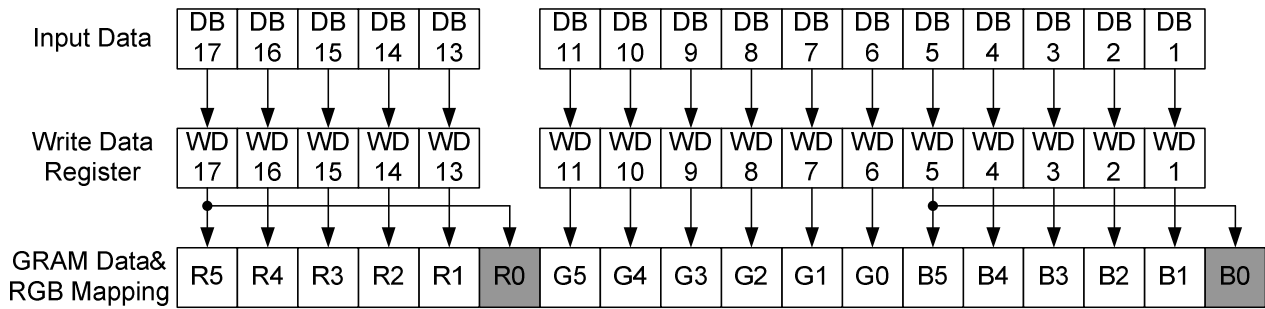

Figure 31 Example of 16-Bit RGB Interface and Data Format

Preliminary

8.4.6 18-bit RGB Interface

The 18-bit RGB interface is selected by setting the RIM[1:0] bits to “00”. The display operation is synchronized with VSYNC, HSYNC, and DOTCLK signals. Display data are transferred to the internal RAM in synchronization with the display operation via 18-bit RGB data bus (DB[17:0]) according to the data enable signal (ENABLE). Registers are set only via the system interface.

RGB Interface With 18-bit Data Bus

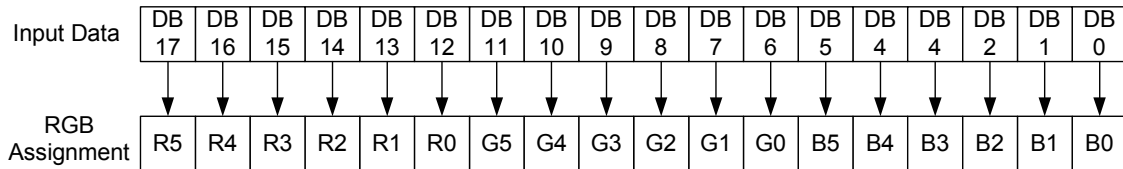

Figure 32 Example of 18-bit RGB Interface and Data Format

Notes to external display in using the RGB Input Interface

1. The following are the functions not available in RGB Input Interface mode.

Function	RGB Interface	I80 System Interface
Partial display	Not available	Available
Scroll function	Not available	Available
Interlaced scan	Not available	Available
Graphics operation function	Not available	Available

2. VSYNC, HSYNC, and DOTCLK signals must be supplied during a display operation period.
3. In RGB interface mode, the panel controlling signals are generated from DOTCLK, not the internal clock generated from the internal oscillator.
4. In 6-bit RGB interface mode, each of RGB dots are transferred in synchronization with DOTCLK signals. In other words, one pixel data needs to take three DOTCLKs to transfer.
5. In 6-bit RGB interface mode, the cycles of VSYNC, HSYNC, ENABLE, DOTCLK signals must be set correctly so that the data transfer is completed in units of pixels.
6. When switching between the internal operation mode and the external display interface operation mode, follow the sequences below in setting instruction.
7. In RGB interface mode, the front porch period continues until the next VSYNC input is detected after drawing one frame.
8. In RGB interface mode, a RAM address (AD[16:0]) is set in the address counter every frame on the falling edge of VSYNC.

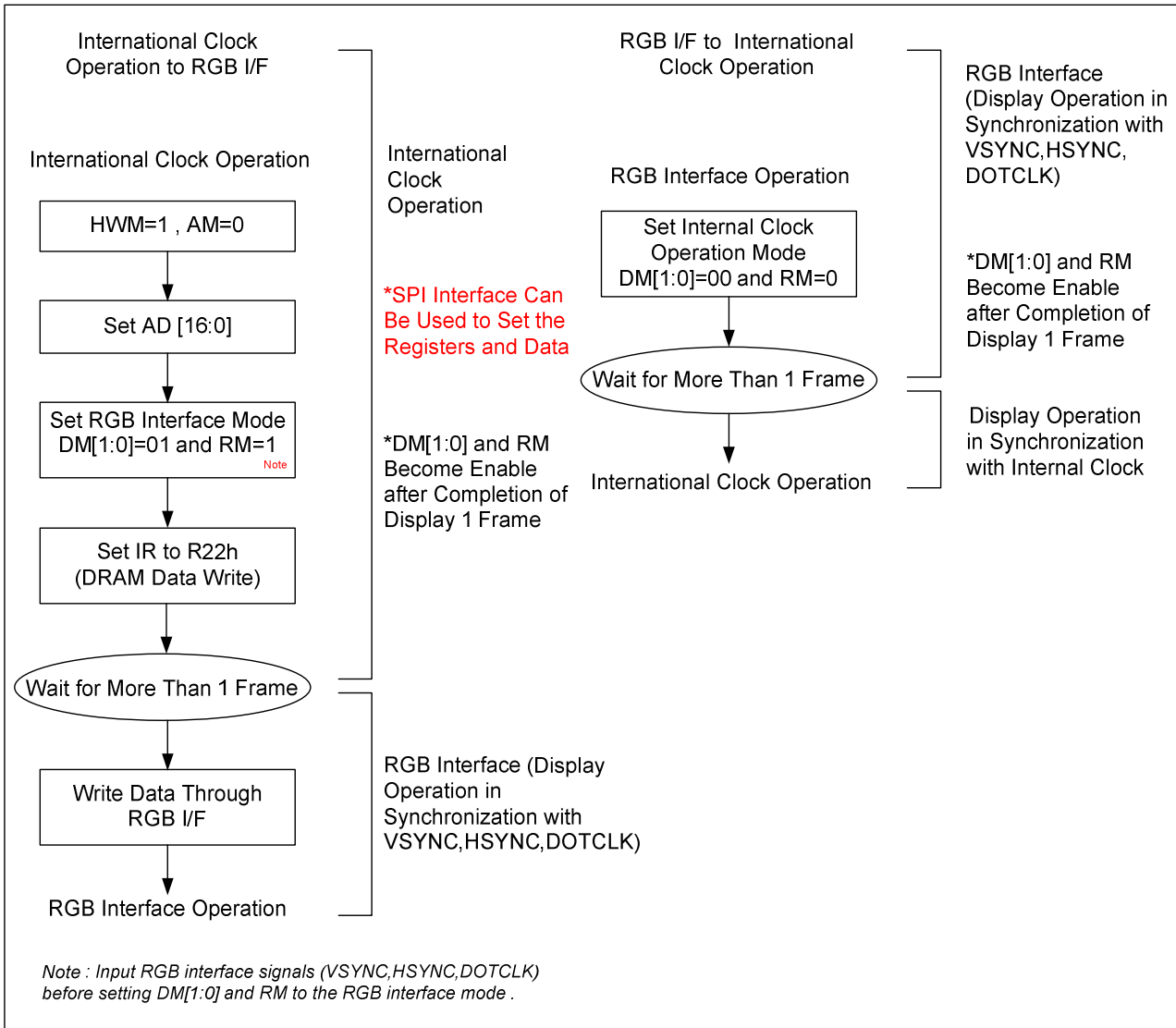

Figure 33 Internal clock operation/RGB interface mode switching

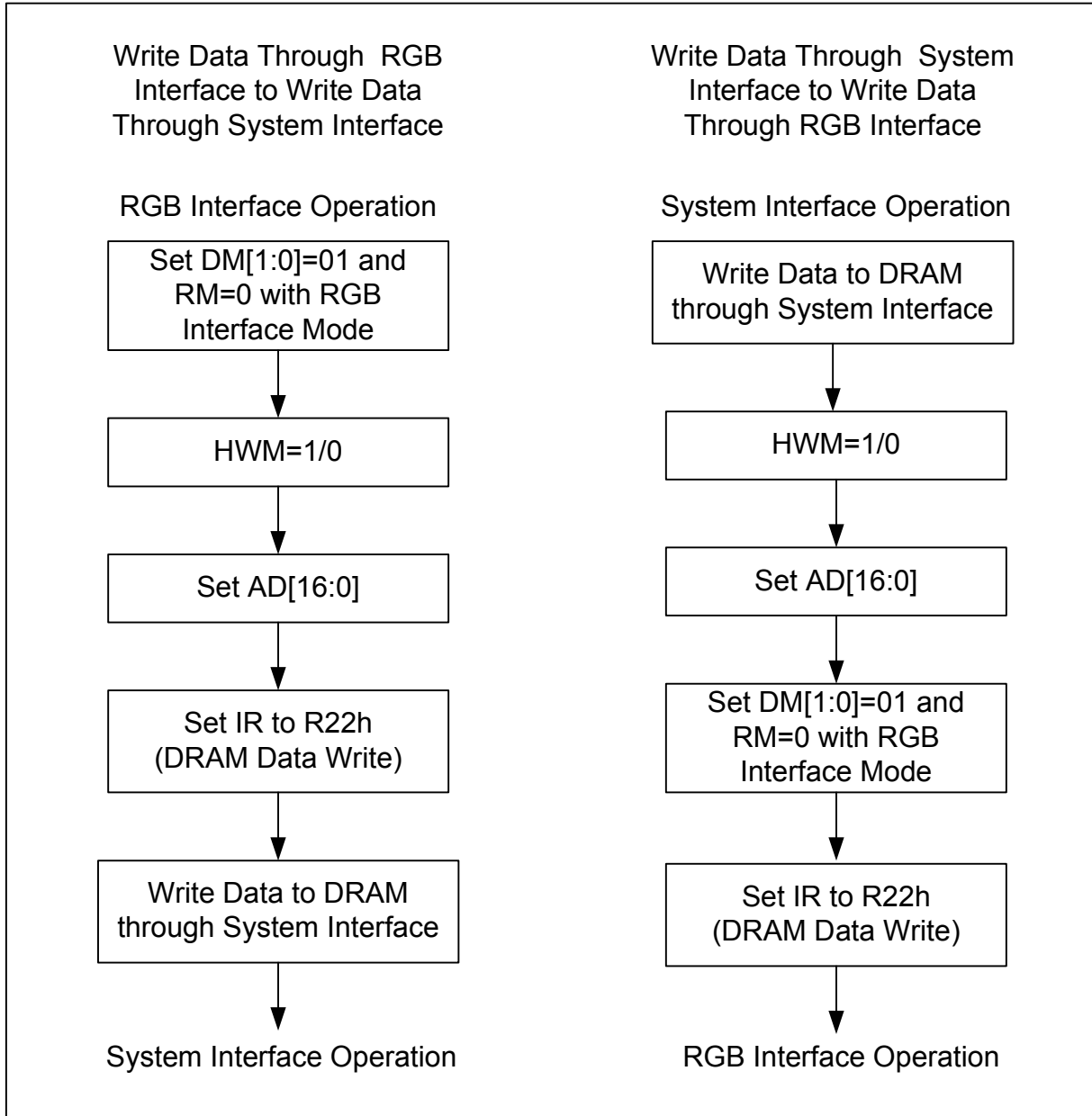

Figure 34 DRAM access between system interface and RGB interface

8.5.. Interface Timing

The following are diagrams of interfacing timing with LCD panel control signals in internal operation and RGB interface.

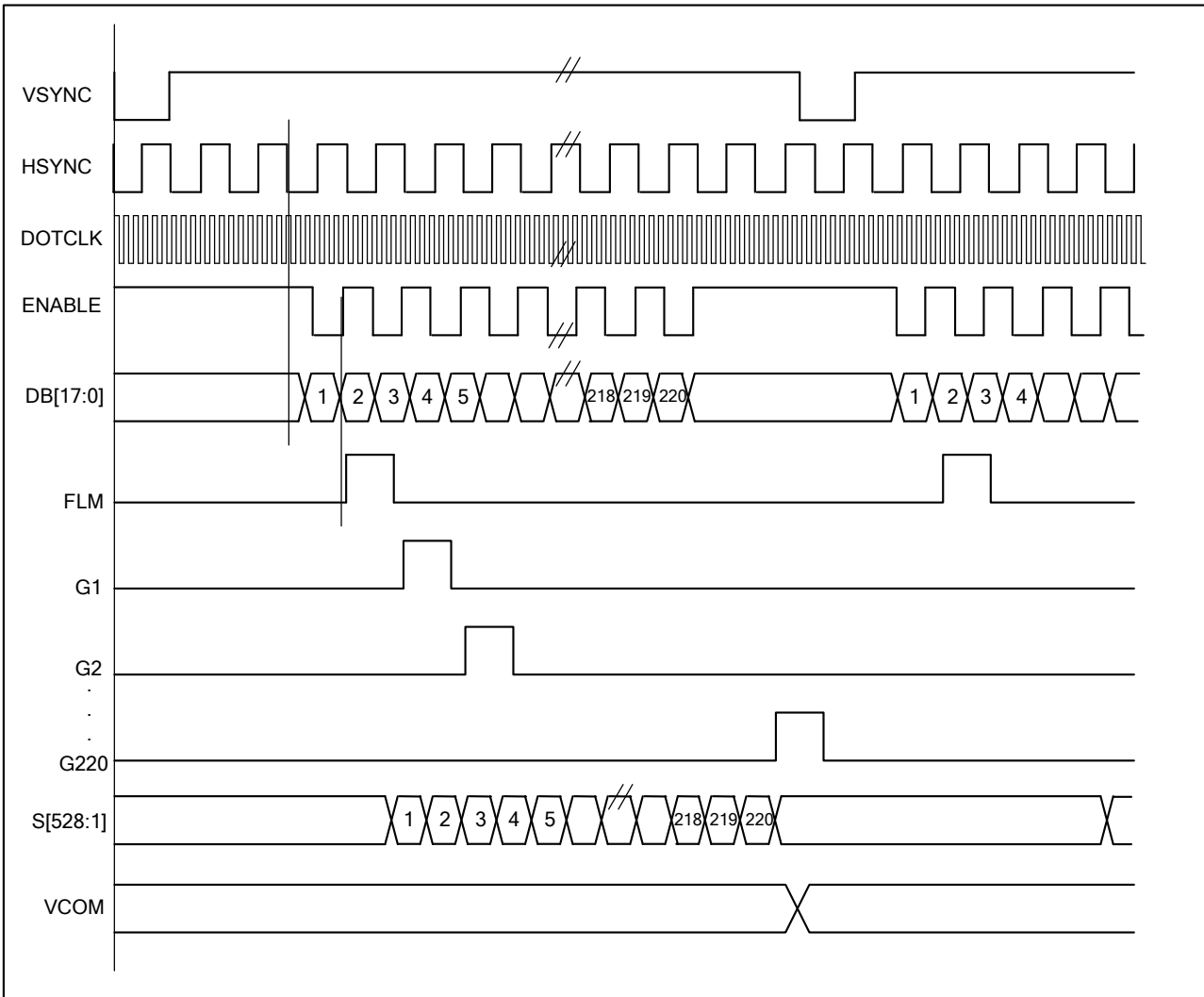

Figure 35 Relationship between RGB I/F signals and LCD Driving Signals for Pane

### 8.6.. 24-bit Serial Peripheral Interface (24-bit SPI)

The Serial Peripheral Interface (SPI) is selected by setting the IM[3:0] pins as “010x” level. The chip select pin (CSX), the serial transfer clock pin (SCL), the serial data input pin (SDI) and the serial data output pin (SDO) are used in SPI mode. The ID pin sets the least significant bit of the identification code. The DB[17:0] pins, which are not used, must be tied to GND.

The SPI interface operation enables from the falling edge of CSX and ends of data transfer on the rising edge of CSX. The start byte is transferred to start the SPI interface and the read/write operation and RS information are also included in the start byte. When the start byte is matched, the subsequent data is received by ST7775R.

The seventh bit of start byte is RS bit. When RS = “0”, either index write operation or status read operation is executed. When RS = “1”, either register write operation or RAM read/write operation is executed. The eighth bit of the start byte is used to select either read or write operation (R/W bit). Data is written when the R/W bit is “0” and read back when the R/W bit is “1”.

After receiving the start byte, ST7775R starts to transfer or receive the data in unit of byte and the data transfer starts from the MSB bit. All the registers of the ST7775R are 16-bit format and receive the first and the second byte data as the upper and the lower eight bits of the 16-bit register respectively. In SPI mode, 5 bytes dummy read is necessary and the valid data starts from 6th byte of read back data.

#### Start Byte Format

Transferred bits	S	8	7	6	5	4	3	2	1
Start byte format	Transfer start	R/W	RS	Device IC Code					
		1/0	1/0	ID	0	1	1	1	0

Notes: .ID bit is selected by setting the IM0/ID pin

#### RS and R/W Bit Function

RS	R/W	Function
0	0	Set an index register
0	1	Read a status
1	0	Write a register or DRAM data
1	1	Read a register or DRAM data



Serial Peripheral Interface for register access

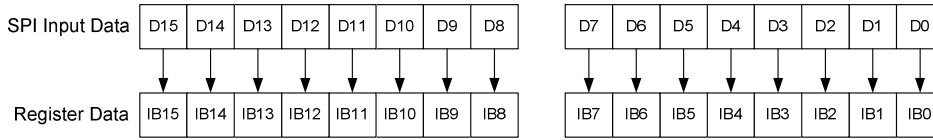

Serial Peripheral Interface 65K colors

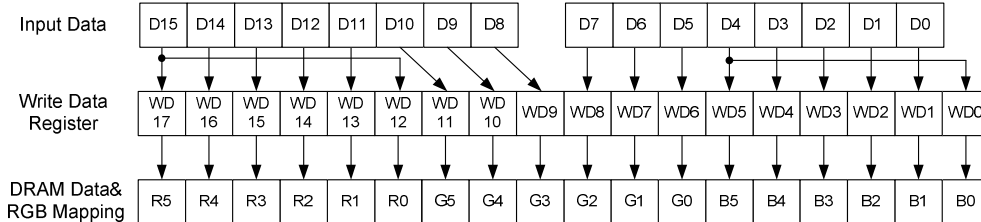

Serial Peripheral Interface 262K colors (TRI=1,DFM=0)

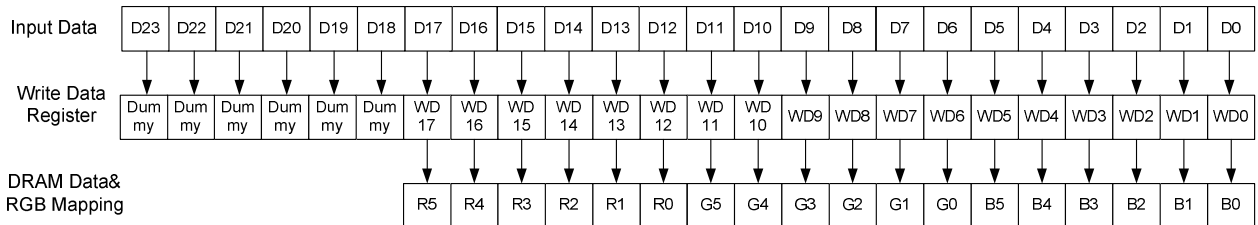

Serial Peripheral Interface 262K colors (TRI=1,DFM=1)

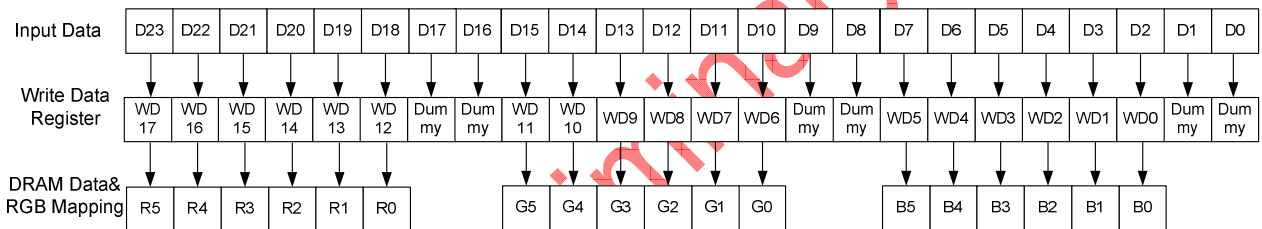

Figure 36 Data Format of SPI Interface

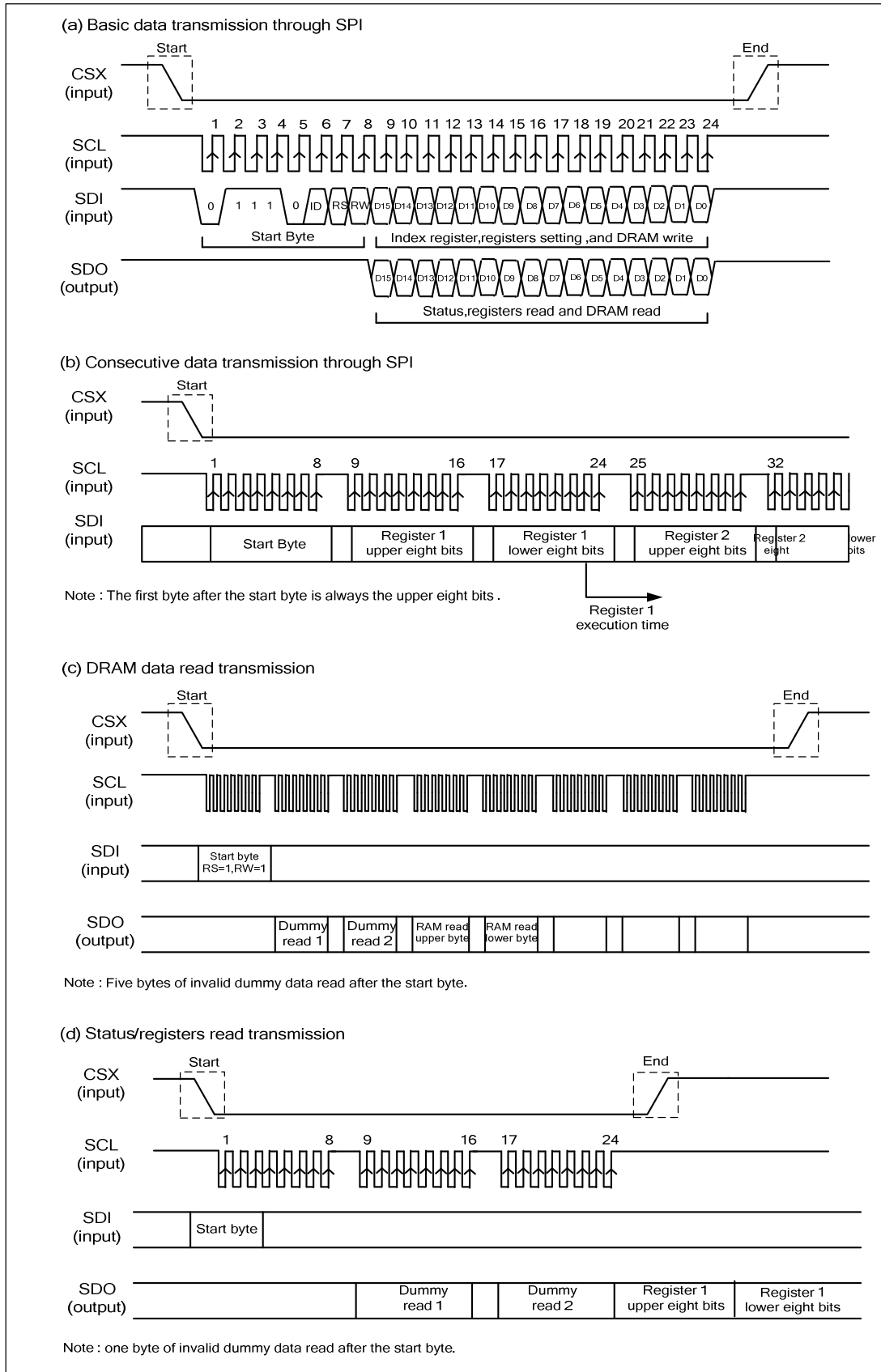
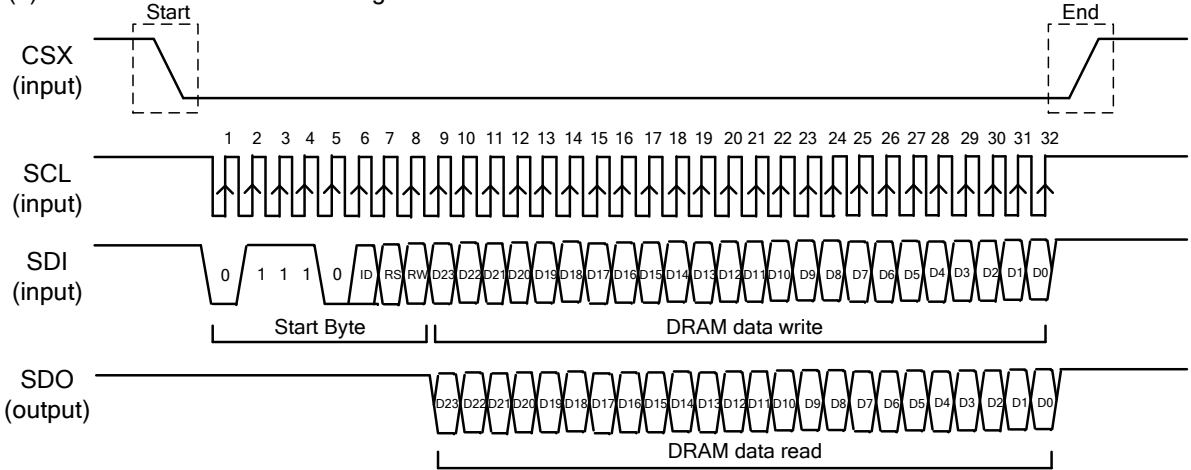
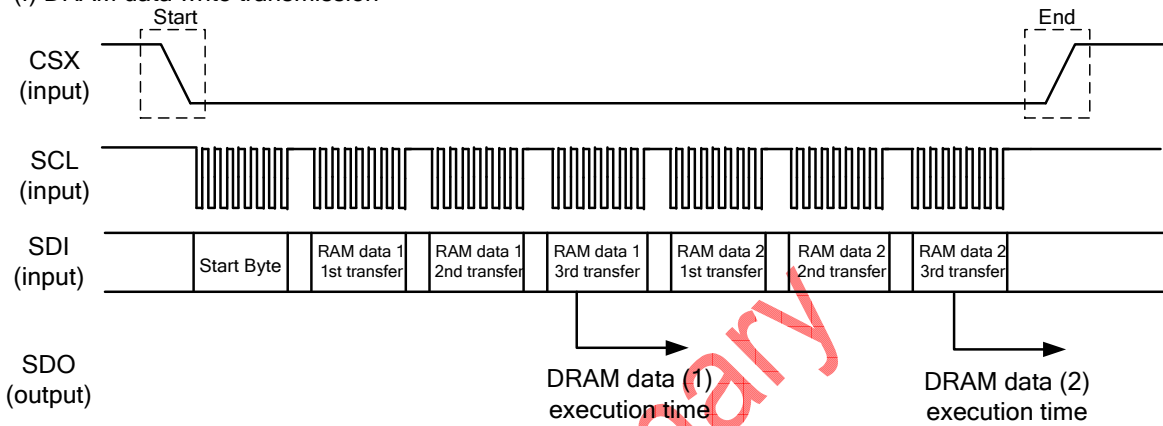

Figure 37 Data transmission through serial peripheral interface (SPI)

(e) Basic data transmission through SPI



(f) DRAM data write transmission



(g) DRAM data read transmission

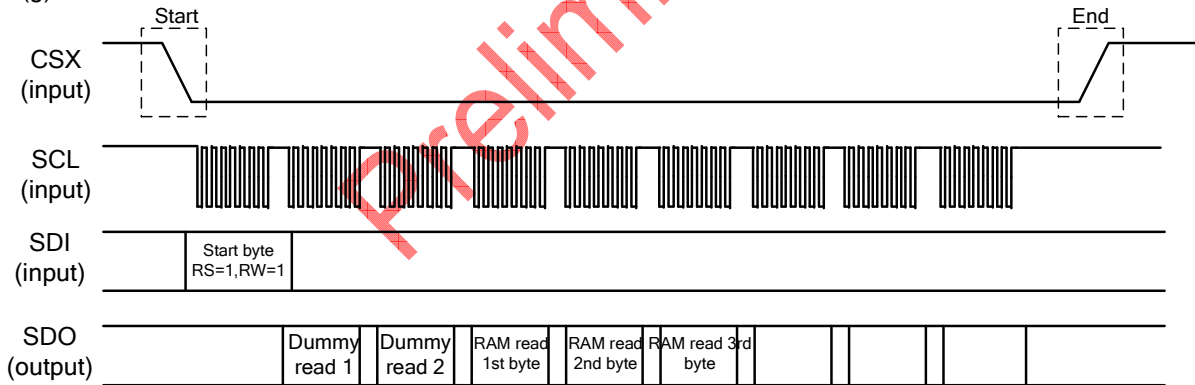

Note : Five bytes of invalid dummy data read after the start byte.

RAM data transfer in SPI mode when MDT[1] = 1 and MDT[0] = 1 or 0

Figure 38 Data transmission through serial peripheral interface (SPI, MDT[1:0] = "1 or 0")

8.7.. 9-bit Serial Peripheral Interface (9-bit SPI)

This SPI mode uses a 3-wire 9-bit serial interface. The chip-select CSX (active low) enables and disables the serial interface. SCL is the serial data clock and SDA is serial data.

Serial data must be input to SDA in the sequence DCX, D7 to D0. The ST7775R reads the data at the rising edge of SCL signal. The first bit of serial data DCX is data/command flag. When DCX = "1", D7 to D0 bits are DRAM data or command parameters. When DCX = "0" D7 to D0 bits are commands.

Register Write Mode:

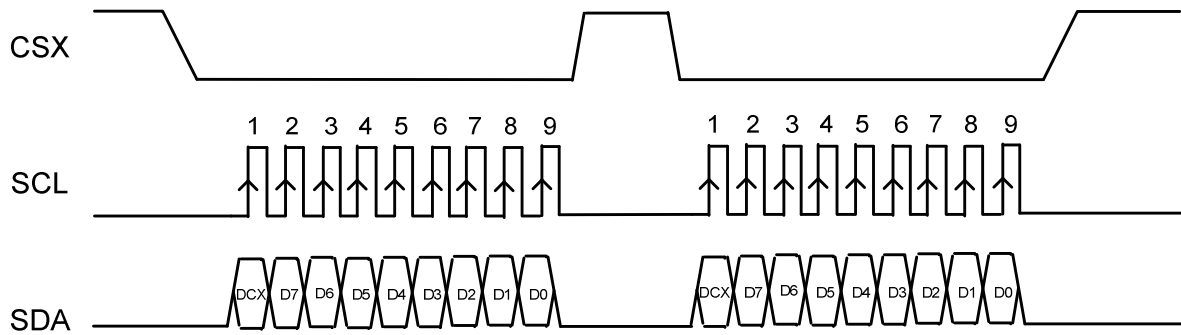

DCX=0: Register Index  
 DCX=1: Register data or DRAM data

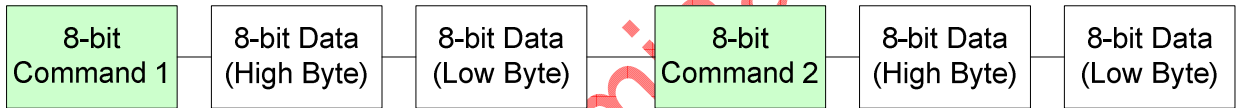

Figure 39 9-bit SPI Write Register Mode

Register Read Mode:

When users need to read back the register or DRAM data, the register R66h must be set as "1" first, and then write the register index to read back the register or DRAM data. The following timing diagrams show examples to read back the register data.

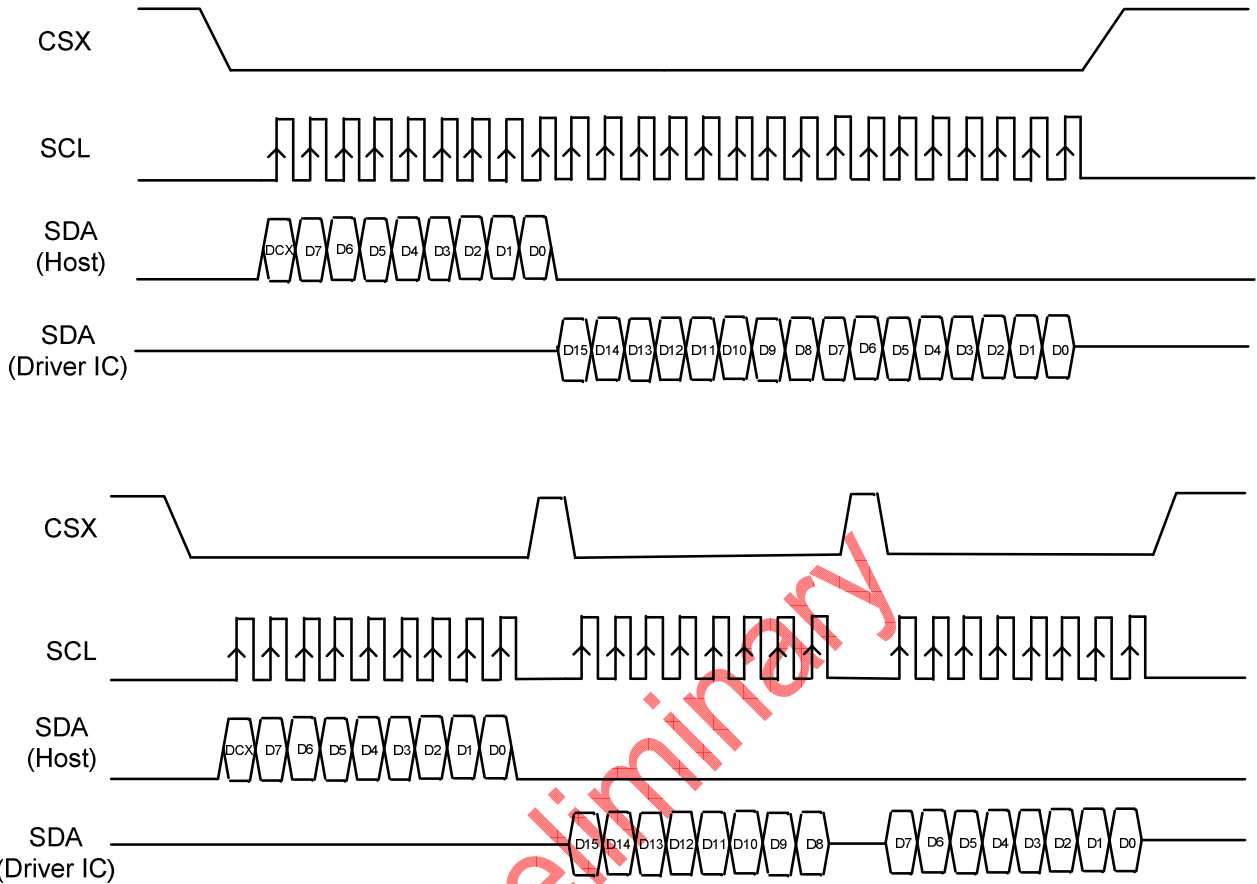

Figure 40 9-bit SPI Read Register mode

9-bit Serial Data Transfer Interface

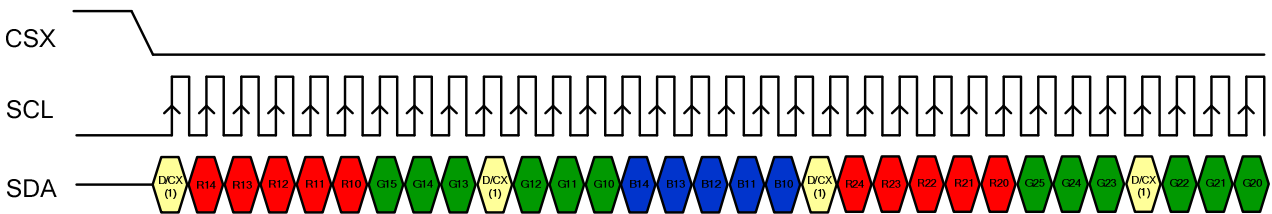

Figure 41 9-bit SPI 65K colors Serial Data Transfer,

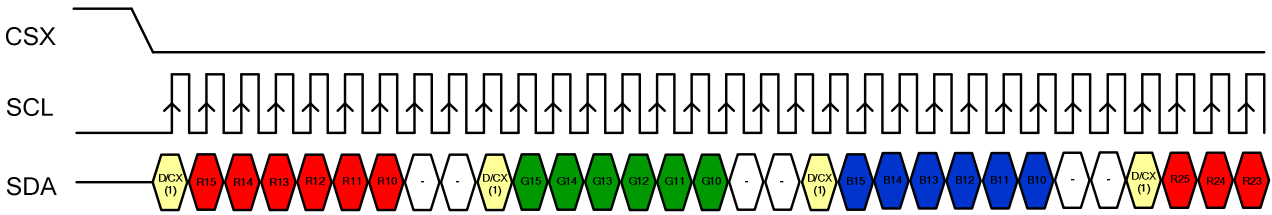

Figure 42 9-bit SPI 262K colors Serial Data Transfer

8.8.. 8-bit Serial Peripheral Interface (8-bit SPI)

This SPI mode uses a 4-wire 8-bit serial interface. The chip-select CSX (active low) enables and disables the serial interface. DCX is the command or data select signal, SCL is the serial data clock and SDA is serial data. Serial data must be input to SDA in the sequence D7 to D0. The ST7775R reads the data at the rising edge of SCL signal. The DCX signal indicates data/command. When DCX = "1", D7 to D0 bits are display RAM data or command parameters. When DCX = "0" D7 to D0 bits are commands.

Register Write Mode:

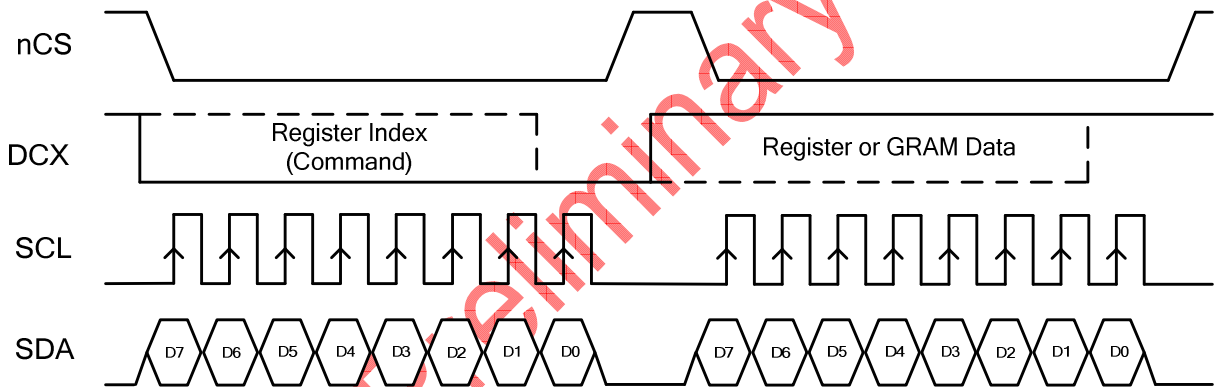

Figure 43 8-bit SPI Write Register Mode

Register Read Mode:

When users need to read back the register or DRAM data, the register R66h must be set as "1" first, and then write the register index to read back the register or DRAM data. The following timing diagrams show examples to read back the register data.

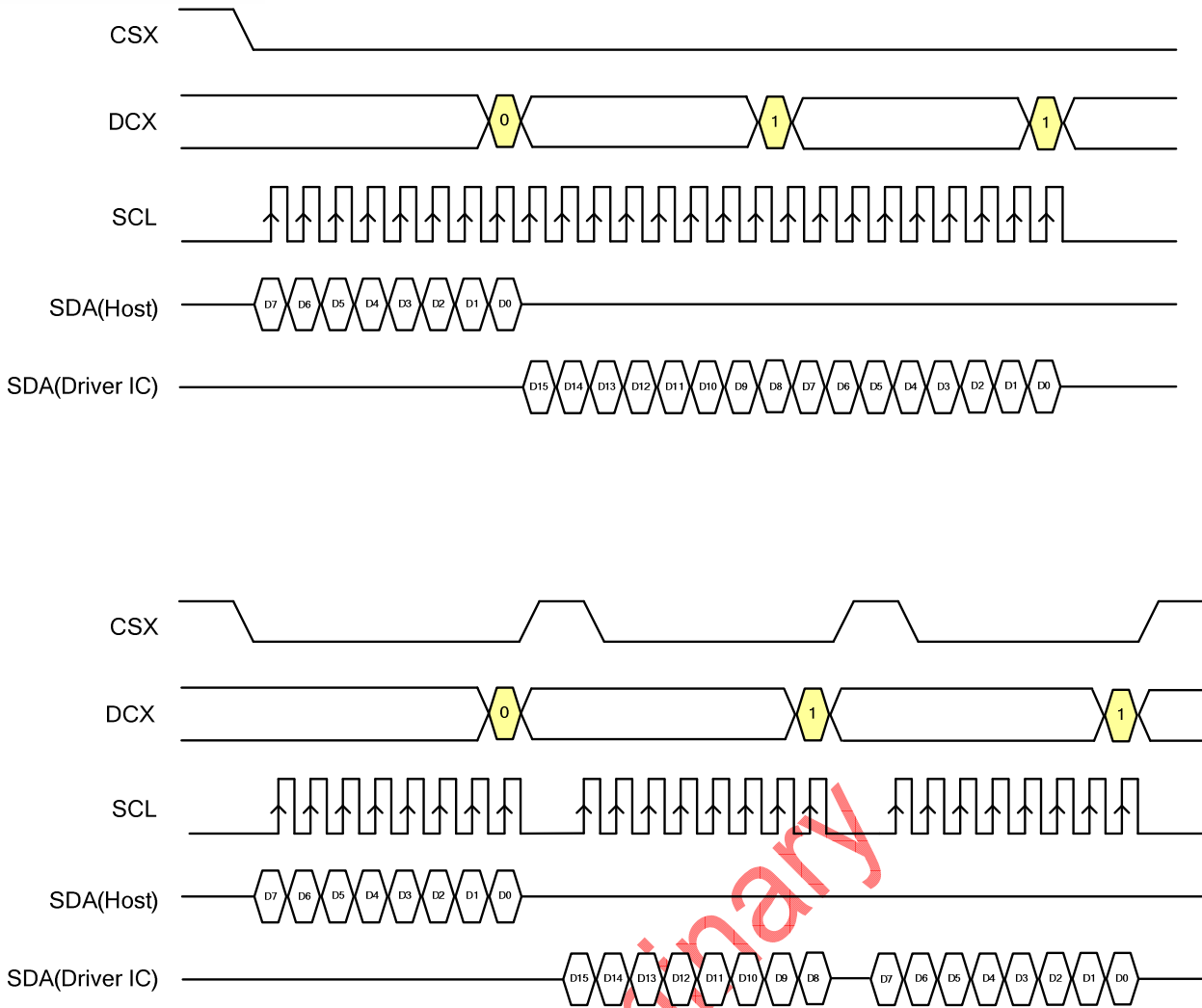

Figure 44 8-bit SPI Read Register mode

8-bit Serial Data Transfer

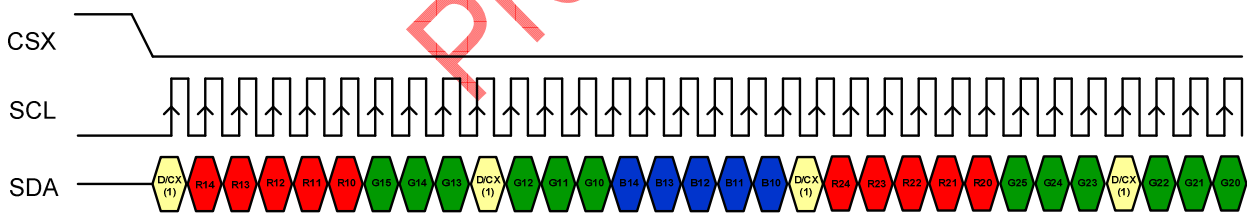

Figure 45 8-bit SPI 65K colors Serial Data Transfer,

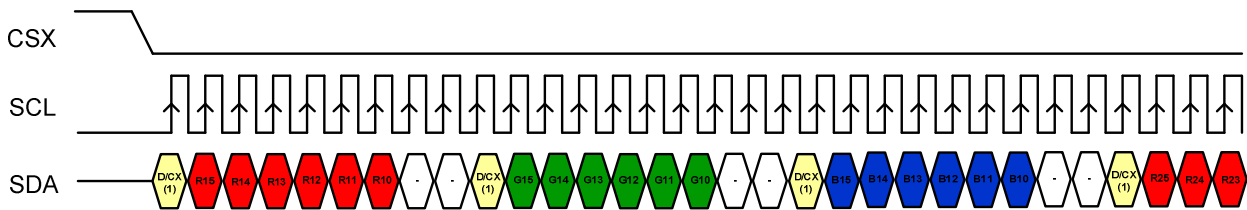

Figure 46 8-bit SPI 262K colors Serial Data Transfer

### 8.9.. Data Transfer Recovery

If there is a break in data transmission while transferring a command or DRAM data or multiple register data, before Bit D0 of the byte has been completed, then the ST7775R will reject the previous bits and have reset the interface such that it will be ready to receive the same byte retransmitted when the chip select line (CSX) is next activated. See the following example:

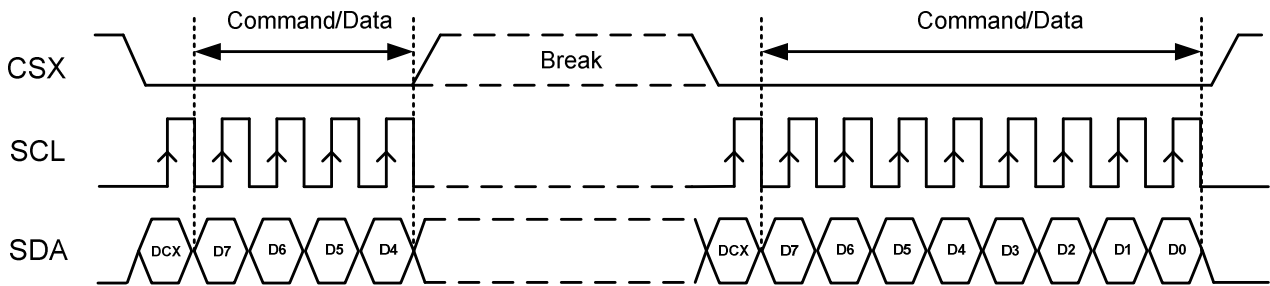

Figure 47 Data Transfer Recovery

If the 2 parameter of command is being sent and a break occurs while sending any parameter before the last one and if the host then sends a new command rather than re-transmitting the parameter that was interrupted, then the parameters that were successfully sent are stored and the parameter where the break occurred is rejected. The interface is ready to receive next byte as show below.

*Note: Break can be e.g. another command or noise pulse.*

### 8.10.. Register Descriptions

ST7775R adopts 18-bit bus interface architecture for high-performance microprocessor. All the functional Blocks of ST7775R starts to work after receiving the correct instruction from the external microprocessor by the 18-, 16-, 9-, 8-bit interface. The index register (IR) stores the register address to which the instructions and Display data will be written. The register selection signal (RS), the read/write signals (RDX/WRX) and data bus D[17:0] are used to read/write the instructions and data of ST7775R. The registers of the ST7775R are categorized into the following groups.

1. Specify the index of register (IR)
2. Read a status
3. Display control
4. Power management Control
5. Graphics data processing



6. Set internal DRAM address (AC)
7. Transfer data to/from the internal DRAM (R22)
8. Internal grayscale  $\gamma$ -correction (R30 ~ R39)

Normally, the display data (DRAM) is most often updated, and in order since the ST7775R can update internal DRAM address automatically as it writes data to the internal DRAM and minimize data transfer by using the window address function, there are fewer loads on the program in the microprocessor. The way of assigning data to the 16 register bits (D[15:0]) varies for each interface. Send registers in accordance with the following data transfer format.

**Serial Peripheral Interface for register access**

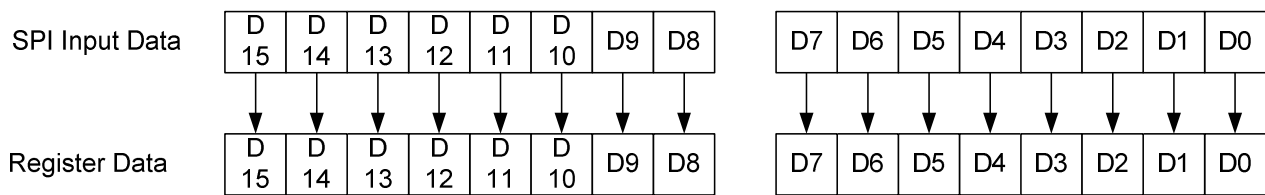
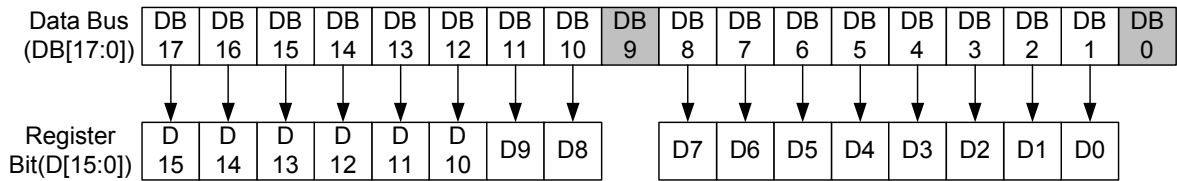

Figure 48 Register Setting with Serial Peripheral Interface (SPI)

Preliminary

**i80-18bits Data bus Interface**



**i80-16bits Data bus Interface**

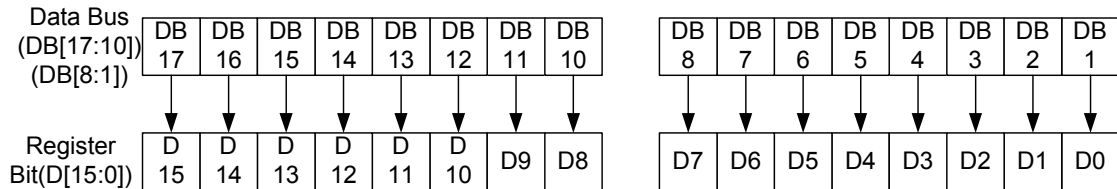

**i80-9bits Data bus Interface**

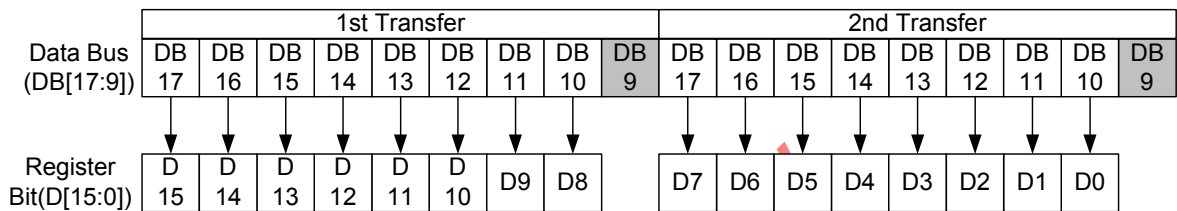

**i80-8bits Data bus Interface / Serial Peripheral Interface (2/3 transmission)**

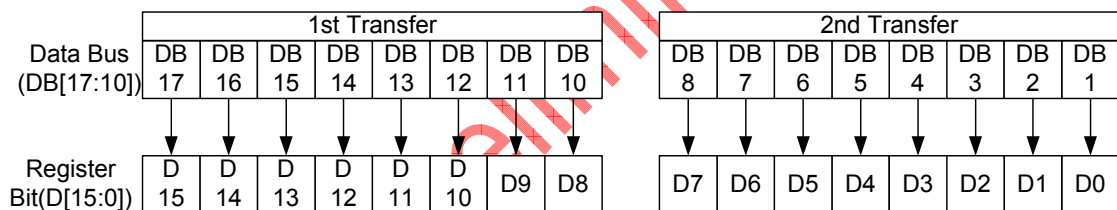
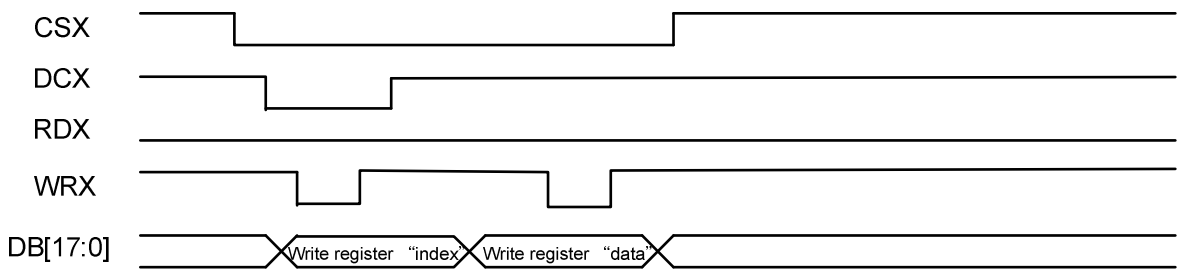

Figure 49 Register setting with i80 System Interface

i80 18-/16-bit System Bus Interface Timing

(a) Write to register



(b) Read from register

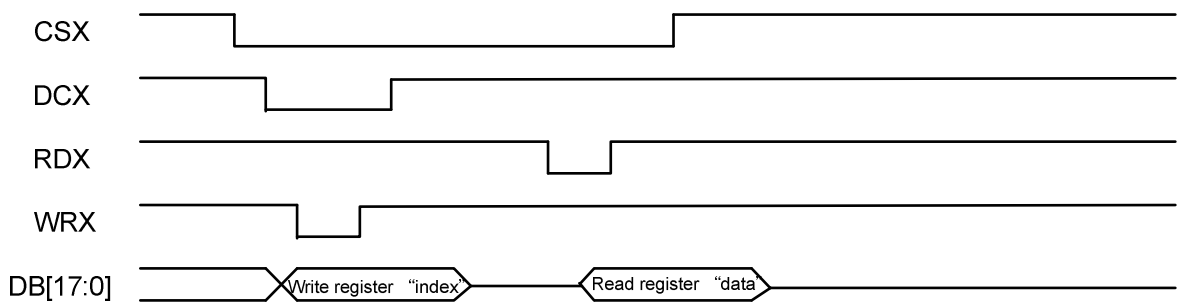

i80 9-/8-bit System Bus Interface Timing

(a) Write to register



(b) Read from register

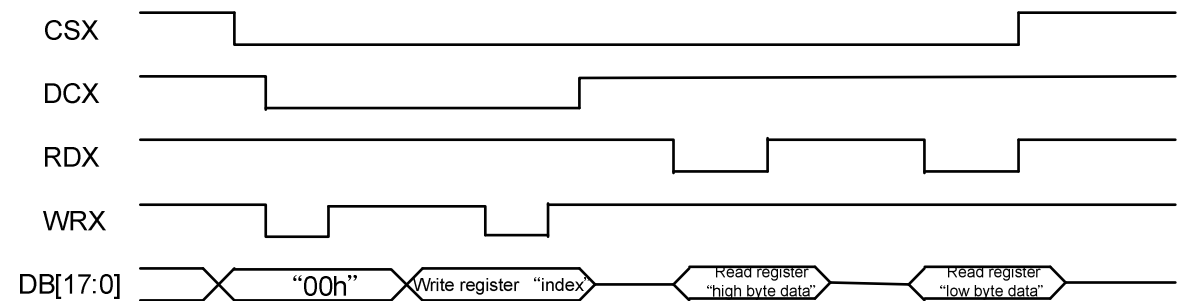

Figure 50 Register Read/Write Timing of i80 System Interface

9 COMMAND

9.1.. System Function Command List

No	Registers	W/R	RS	D15	D14	D13	D12	D11	D10	D9	D8	D7	D6	D5	D4	D3	D2	D1	D0
<a href="#">1R</a>	Index Register	W	0	-	-	-	-	-	-	-	-	ID7	ID6	ID5	ID4	ID3	ID2	ID1	ID0
<a href="#">00h</a>	Driver Code Read	R	1	0	1	1	1	0	1	1	1	0	1	1	1	0	1	0	1
<a href="#">01h</a>	Driver Output Control	W/R	1	VSPL	HSPL	DPL	EPL	0	SM	GS	SS	0	0	0	NL4	NL3	NL2	NL1	NL0
<a href="#">02h</a>	LCD Driving Control	W/R	1	0	0	0	0	0	0	0	INV	0	0	0	0	0	0	0	0
<a href="#">03h</a>	Entry Mode	W/R	1	0	0	0	BGR	0	0	MDT1	MDT0	0	0	I/D1	I/D0	AM	0	0	0
<a href="#">07h</a>	Display Control 1	W/R	1	0	0	0	TEMON	0	0	0	0	0	0	0	GON	CL	REV	D1	D0
<a href="#">08h</a>	Display control 2	W/R	0	0	0	0	FP3	FP2	FP1	FP0	0	0	0	0	BP3	BP2	BP1	BP0	0
<a href="#">0Bh</a>	Display Control 4	W/R	1	0	0	0	0	0	0	0	0	0	0	0	RTN3	RTN2	RTN1	RTN0	0
<a href="#">0Ch</a>	RGB Display Interface Control 1	W/R	1	0	0	0	0	0	0	0	RM	0	0	0	DM	0	0	RIM1	RIM0
<a href="#">0Fh</a>	Frame Marker Position	W/R	1	0	0	0	0	0	0	0	0	0	0	0	0	0	0	0	OSC_EN
<a href="#">10h</a>	Power Control 1	W/R	1	0	0	0	0	0	0	0	0	0	0	0	0	0	0	SLP	STB
<a href="#">11h</a>	Power Control 2	W/R	1	0	0	0	APON	0	0	0	0	0	0	0	0	0	0	0	0
<a href="#">20h</a>	Horizontal DRAM Address Set	W/R	1	0	0	0	0	0	0	0	0	AD7	AD6	AD5	AD4	AD3	AD2	AD1	AD0
<a href="#">21h</a>	Vertical DRAM Address Set	W/R	1	0	0	0	0	0	0	0	0	AD15	AD14	AD13	AD12	AD11	AD10	AD9	AD8
<a href="#">22h</a>	Write Data to GRAM	W	1	DRAM Write Data (WD17-0) / Read Data (RD17-0)															
<a href="#">22h</a>	Read Data from GRAM	R	1																
<a href="#">28h</a>	Software Reset	W	1	0	0	0	0	0	0	0	0	0	0	0	0	0	0	0	0
<a href="#">30h</a>	Gate Scan Control	W/R	1	0	0	0	0	0	0	0	0	0	0	0	SCN4	SCN3	SCN2	SCN1	SCN0
<a href="#">31h</a>	Vertical Scroll Control 1	W/R	1	0	0	0	0	0	0	0	0	SEA7	SEA6	SEA5	SEA4	SEA3	SEA2	SEA1	SEA0
<a href="#">32h</a>	Vertical Scroll Control 2	W/R	1	0	0	0	0	0	0	0	0	SSA7	SSA6	SSA5	SSA4	SSA3	SSA2	SSA1	SSA0
<a href="#">33h</a>	Vertical Scroll Control 3	W/R	1	0	0	0	0	0	0	0	0	SST7	SST6	SST5	SST4	SST3	SST2	SST1	SST0
<a href="#">34h</a>	Partial Driving Control 1	W/R	1	0	0	0	0	0	0	0	0	SE17	SE16	SE15	SE14	SE13	SE12	SE11	SE10
<a href="#">35h</a>	Partial Driving Control 2	W/R	1	0	0	0	0	0	0	0	0	SS17	SS16	SS15	SS14	SS13	SS12	SS11	SS10
<a href="#">36h</a>	Horizontal Address End Position	W/R	1	0	0	0	0	0	0	0	0	HEA7	HEA6	HEA5	HEA4	HEA3	HEA2	HEA1	HEA0
<a href="#">37h</a>	Horizontal Address Start Position	W/R	1	0	0	0	0	0	0	0	0	HSA7	HSA6	HSA5	HSA4	HSA3	HSA2	HSA1	HSA0
<a href="#">38h</a>	Vertical Address End Position	W/R	1	0	0	0	0	0	0	0	0	VEA7	VEA6	VEA5	VEA4	VEA3	VEA2	VEA1	VEA0

<b>39h</b>	Vertical Address Start Position	W/R	1	0	0	0	0	0	0	0	0	0	VSA7	VSA6	VSA5	VSA4	VSA3	VSA2	VSA1	VSA0		
<b>50h</b>	Gamma Control 1	W/R	1	0	0	0	0	0	0	KP1[2]	KP1[1]	KP1[0]	0	0	0	0	0	KP0[2]	KP0[1]	KP0[0]		
<b>51h</b>	Gamma Control 2	W/R	1	0	0	0	0	0	0	KP3[3]	KP3[2]	KP3[1]	KP3[0]	0	0	0	0	KP2[3]	KP2[2]	KP2[1]	KP2[0]	
<b>52h</b>	Gamma Control 3	W/R	1	0	0	0	0	0	0	KP5[2]	KP5[1]	KP5[0]	0	0	0	0	0	KP4[3]	KP4[2]	KP4[1]	KP4[0]	
<b>53h</b>	Gamma Control 4	W/R	1	0	0	SELV63 P[2]	SELV63 P[1]	SELV63 P[0]	SELV62 P[2]	SELV62 P[1]	SELV62 P[0]	SELV1 P[3]	SELV1 P[2]	SELV1 P[1]	SELV1 P[0]	SELV0 P[3]	SELV0 P[2]	SELV0 P[1]	SELV0 P[0]	SELV0 P[0]		
<b>54h</b>	Gamma Control 5	W/R	1	0	0	0	0	VOS0 P[3]	VOS0 P[2]	VOS0 P[1]	VOS0 P[0]	0	0	0	0	0	VRF0 P[3]	VRF0 P[2]	VRF0 P[1]	VRF0 P[0]		
<b>55h</b>	Gamma Control 6	W/R	1	0	0	0	0	0	KN1[2]	KN1[1]	KN1[0]	0	0	0	0	0	0	KN0[2]	KN0[1]	KN0[0]		
<b>56h</b>	Gamma Control 7	W/R	1	0	0	0	0	0	KN3[3]	KN3[2]	KN3[1]	KN3[0]	0	0	0	0	0	KN2[3]	KN2[2]	KN2[1]	KN2[0]	
<b>57h</b>	Gamma Control 8	W/R	1	0	0	0	0	0	KN5[2]	KN5[1]	KN5[0]	0	0	0	0	0	0	KN4[3]	PKN4[2]	KN4[1]	KN4[0]	
<b>58h</b>	Gamma Control 9	W/R	1	0	0	SELV63 N[2]	SELV63 N[1]	SELV63 N[0]	SELV62 N[2]	SELV62 N[1]	SELV62 N[0]	SELV1 N[3]	SELV1 N[2]	SELV1 N[1]	SELV1 N[0]	SELV0 N[3]	SELV0 N[2]	SELV0 N[1]	SELV0 N[0]	SELV0 N[0]		
<b>59h</b>	Gamma Control 10	W/R	1	0	0	0	0	VOS0 N[3]	VOS0 N[2]	VOS0 N[1]	VOS0 N[0]	0	0	0	0	0	0	VRF0 N[3]	VRF0 N[2]	VRF0 N[1]	VRF0 N[0]	
<b>65h</b>	ID code	R		0	0	0	0	0	0	0	0	0	0	0	0	0	0	ID3	ID2	ID1	ID0	
<b>66h</b>	SPI Read/Write Control	W/R	1	0	0	0	0	0	0	0	0	0	0	0	0	0	0	0	0	0	R/WX	
<b>B0h</b>	Power Control 3	W/R	1	0	0	VCM5	VCM4	VCM3	VCM2	VCM1	VCM0	0	0	VGLSEL 1	VGLSEL 0	0	0	0	0	VGHBT1	VGHBT0	
<b>B1h</b>	Power Control 4	W/R	1	0	0	0	VRHN4	VRHN3	VRHN2	VRHN1	VRHN0	0	0	0	0	0	0	VRHP4	VRHP3	VRHP2	VRHP1	VRHP0
<b>B2h</b>	Power Control 5	W/R	1	0	0	0	0	0	AVCLS2	AVCLS1	AVCLS0	0	0	BCLK_DI V1	BCLK_DI V0	0	0	AVDDS2	AVDDS1	AVDDS0		
<b>D2h</b>	NVM ID Code	W/R	1	0	0	0	0	0	0	0	0	0	0	0	0	0	0	ID3	ID2	ID1	ID0	
<b>D9h</b>	NVM Control Status	W/R	1	0	0	0	0	0	0	0	0	0	0	VMF_EN	0	0	0	0	0	0	0	
<b>DFh</b>	NVM Write Command	W	1	0	0	0	0	0	0	0	0	0	1	0	1	0	0	0	1	0	1	
<b>FAh</b>	NVM Enable	W/R	1	0	0	0	0	0	0	0	0	0	PROG _MODE	0	0	0	0	0	1	MTP _PROG	0	
<b>FEh</b>	NVM VCOM Offset	W/R	1	0	0	0	0	0	0	0	0	0	0	0	0	VMF4	VMF3	VMF2	VMF1	VMF0		
<b>FFh</b>	NVM Command Enable	W	1	0	0	0	0	0	0	0	0	0	0	0	0	0	0	0	0	CMD1_ EN	CMD2_ EN	

Table 10 System Function Command List

9.2.. System Function Command

9.2.1 Index (IR)

Note: “-“Don't care

Index(IR)																		
RS	WRX	RDX	D15	D14	D13	D12	D11	D10	D9	D8	D7	D6	D5	D4	D3	D2	D1	D0
0	↑	1	-	-	-	-	-	-	-	-	ID7	ID6	ID5	ID4	ID3	ID2	ID1	ID0
<b>Description</b>			The index register specifies the index R00h to RFFh of the control register or RAM control to be accessed. The access to the register and instruction bits in it is prohibited unless the index is specified in the index register.															

9.2.2 Device ID Code Read (R00h)

Device ID Code Read Out (R00h)																		
RS	WRX	RDX	D15	D14	D13	D12	D11	D10	D9	D8	D7	D6	D5	D4	D3	D2	D1	D0
1	1	↑	0	1	1	1	0	1	1	1	0	1	1	1	0	1	0	1
<b>Description</b>			When read this register, the device output device ID code															

9.2.3 Device Output Control (R01h)

Device Output Control (R01H)																		
RS	WRX	RDX	D15	D14	D13	D12	D11	D10	D9	D8	D7	D6	D5	D4	D3	D2	D1	D0
1	↑	1	VSPL	HSPL	DPL	EPL	0	SM	GS	SS	0	0	0	NL4	NL3	NL2	NL1	NL0
<b>Default value</b>			0	0	0	0	0	0	0	0	0	0	0	1	1	1	0	0
<b>Description</b>			<p><b>VSPL</b> : Sets the signal polarity of the VSYNC pin.                      VSPL="0", Low active                      VSPL="1", High active</p> <p><b>HSPL</b> : Sets the signal polarity of the HSYNC pin.                      HSPL="0", Low active                      HSPL="1", High active</p> <p><b>DPL</b> : Sets the signal polarity of the DOTCLK pin.                      DPL = "0" The data is input on the positive edge of DOTCLK                      DPL = "1" The data is input on the negative edge of DOTCLK</p> <p><b>EPL</b>: Sets the signal polarity of the ENABLE pin.                      EPL = "0"                      The data DB17-0 is written when ENABLE = "0".                      Disable write data operation when ENABLE = "1"</p>															

EPL = "1"

The data DB17-0 is written when ENABLE = "1".

Disable write data operation when ENABLE = "0".

**SS:** Select the shift direction of outputs from the source driver.

When SS = 0, the shift direction of outputs is from S1 to S528

When SS = 1, the shift direction of outputs is from S528 to S1.

In addition to the shift direction, the settings for both SS and BGR bits are required to change the Assignment of R, G, B dots to the source driver pins.

To assign R, G, B dots to the source driver pins from S1 to S528, set SS = 0.

To assign R, G, B dots to the source driver pins from S528 to S1, set SS = 1.

*Note: When changing SS or BGR bits, DRAM data must be rewritten.*

**GS:** Sets the direction of scan by the gate driver. Set GS bit in combination with SM and SS bits for the convenience of the display module configuration and the display direction.

**SM:** Sets the gate driver pin arrangement in combination with the GS bit to select the optimal scan mode for the module.

SM	GS	Scan Direction	Gate Output Sequence
0	0		<p>G1,G2,G3,G4.....,G220</p> <p>G217,G218,G219, G220</p>
0	1		<p>G220,G219,.....G216</p> <p>G7,G6,G5,G4,G3,G2,G1</p>

	1	0		<p>G1,G3,G5.....G211 G213,G215,G217,G219</p> <p>G2,G4,G6.....G212 G214,G216,G218,G220</p>
	1	1		<p>G220,G218,.....G14 G12,G10,G8,G6,G4,G2</p> <p>G219,G217.....G13 G11,G9,G7,G5,G3,G1</p>

**NL [4:0]:** Sets the number of lines to drive the LCD at an interval of 8 lines. The DRAM address mapping is not affected by the number of lines set by NL[4:0]. The number of lines must be the same or more than the number of lines necessary for the size of the liquid crystal panel.

NL[4:0]	LCD Drive Line	NL[4:0]	LCD Drive Line
6'h00	Reserved	.	.
6'h01	8 lines	.	.
6'h02	16 lines	.	.
6'h03	24 lines	6'h1A	208 lines
6'h04	32 lines	6'h1B	216 lines
6'h05	40 lines	6'h1C	220 lines

9.2.4 LCD Driving Wave Control (R02h)

LCD Driving Wave Control (R02h)																		
RS	WRX	RDX	D15	D14	D13	D12	D11	D10	D9	D8	D7	D6	D5	D4	D3	D2	D1	D0
1	↑	1	0	0	0	0	0	0	0	INV	0	0	0	0	0	0	0	0
<b>Default value</b>			0	0	0	0	0	0	0	0	0	0	0	0	0	0	0	0
<b>Description</b>			<p><b>INV:</b> VCOM Driving Wave Control.</p> <p>When INV = 0, the column inversion is selected</p> <p>When INV = 1, the dot inversion is selected.</p>															

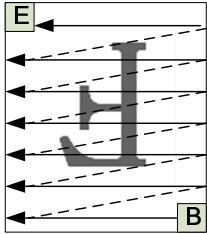
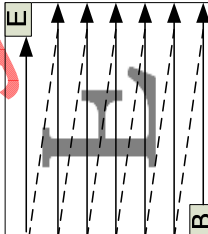
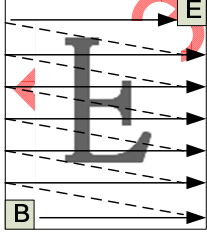
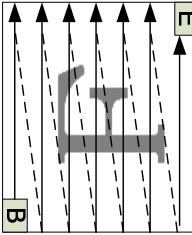
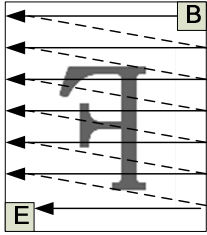
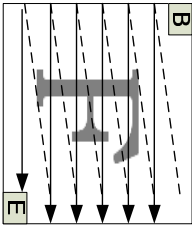

9.2.5 Entry Mode (R03h)

Entry Mode (R03h)																		
RS	WRX	RDX	D15	D14	D13	D12	D11	D10	D9	D8	D7	D6	D5	D4	D3	D2	D1	D0
1	↑	1	0	0	0	BGR	0	0	MDT1	MDT0	0	0	I/D1	I/D0	AM	0	0	0
Default value			0	0	0	0	0	0	0	0	0	0	1	1	0	0	0	0
Description			<p><b>AM:</b> Sets the DRAM Update Direction                      When AM = "0", set the horizontal writing direction.                      When AM = "1", set the vertical writing direction.                      When a window area is set by registers R36h/R37h and R38h/R39h, only the addressed DRAM area is updated based on I/D [1:0] and AM bits setting.</p> <p><b>I/D [1:0]:</b> Control the address counter (AC) to automatically increase or decrease by 1 when update one pixel display data.</p>															
			AM	ID[1:0]	Write DRAM Direction		AM	ID[1:0]	Write DRAM Direction									
			0	00			1	00										
			0	01			1	01										
0	10			1	10													

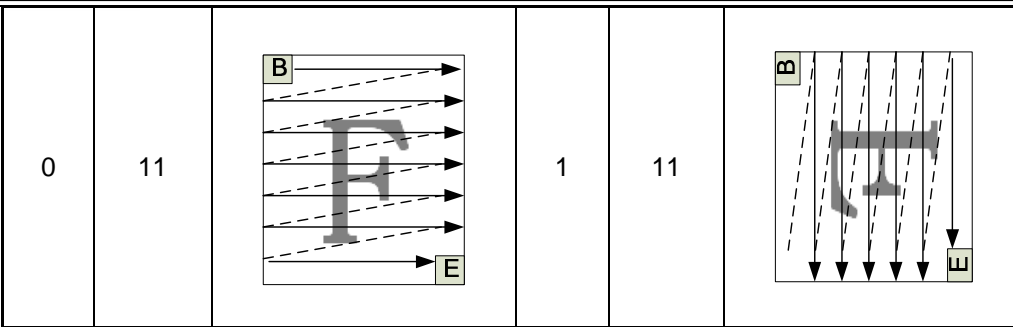

AM	I/D[1:0]	Register R20/R21 Start Address	
0/1	00	R20	00AFh
		R21	00DBh
	01	R20	0000h
		R21	00DBh
	10	R20	00AFh
		R21	0000h
	11	R20	0000h
		R21	0000h

**BGR:** Reverses the order from RGB to BGR in writing 18-bit pixel data in the DRAM.

BGR = 0: Write data in the order of RGB to the DRAM.

BGR=0																	
D17	D16	D15	D14	D13	D12	D11	D10	D9	D8	D7	D6	D5	D4	D3	D2	D1	D0
R5	R4	R3	R2	R1	R0	G5	G4	G3	G2	G1	G0	B5	B4	B3	B2	B1	B0

BGR = 1: Reverse the order from RGB to BGR in writing data to the DRAM.

BGR=1																	
D17	D16	D15	D14	D13	D12	D11	D10	D9	D8	D7	D6	D5	D4	D3	D2	D1	D0
B5	B4	B3	B2	B1	B0	G5	G4	G3	G2	G1	G0	R5	R4	R3	R2	R1	R0

**MDT1:** This bit is active on the 80-system of 8-bit bus and the data for 1-pixel is transported to the memory for 3 write cycles. This bit is on the 80-system of 16-bit bus, and the data for 1-pixel is transported to the memory for 2 write cycles. When the 80-system interface mode is not set in the 8-bit or 16-bit mode set MDT1 bit to be "0".

**MDT0:** When 8-bit or 16-bit 80 interface mode and MDT1 bit =1, MDT0 defines color depth for the IC.

Interface	MDT1	MDT0	Write data to DRAM
*	0	0	Default transfer value. Multiple data transfer (MDT[1:0]) function is not available. Data transfer is controlled by interface mode
	0	1	Multiple data transfer (MDT[1:0]) function is not available
8080-8 bit	1	0	
	1	1	

Interface	MDT1	MDT0	Write data to DRAM
8080-16bit	0	1	
		0	
	1	1	

- 8bit (8080-8 bit),MDT0=0:262k-coloer (3 times of 6-bit data transfer to DRAM)
- 8bit (8080-8 bit),MDT0=1:65k-coloer (5-bit,6-bit,5-bit data transfer to DRAM)
- 8bit (8080-16bit),MDT0=0:262k-coloer (16-bit ,2-bit data transfer to DRAM)
- 8bit (8080-16 bit),MDT0=1:262k-coloer (2-bit,16-bit data transfer to DRAM)

9.2.6 Display Control 1 (R07h)

Display Control 1 (R07h)

RS	WRX	RDX	D15	D14	D13	D12	D11	D10	D9	D8	D7	D6	D5	D4	D3	D2	D1	D0
1	↑	1	0	0	0	TEMON	0	0	0	0	0	0	0	GON	CL	REV	D1	D0
<b>Default value</b>			0	0	0	0	0	0	0	0	0	0	0	0	0	0	0	0

**D [1:0]:** A graphics display is turned on the screen when writing D1 = "1", and is turned off when writing D1 = "0". When writing D1 = "0", the graphics display data is retained in the internal DRAM and the ST7775R displays the data when writing D1 = "1". When D1 = "0", i.e. while no display is shown on the panel, all source outputs becomes the GND level to reduce charging/discharging current, which is generated within the LCD while driving liquid crystal with AC voltage.

When the display is turned off by setting D [1:0] =00, the ST7775R's internal display operation is halted completely. In combination with the GON setting, the D [1:0] setting controls display ON/OFF.

D1	D0	GON	Source Output	Gate Output	VCOM Output	Display
0	0	X	VSS	VGL	VSS	Off
0	1	0	VSS	VGL	VSS	Off
		1	VSS	Operate	VSS	Off
1	0	0	White on Normally White Panel Black on Normally Black Panel	VGL	Operate	Off
		1	White on Normally White Panel Black on Normally Black Panel	Operate	Operate	Off
1	1	0	Normally Display	VGL	Operate	Off
		1	Normally Display	Operate	Operate	On

Note1: Data write operation from the microcontroller is performed irrespective of the setting of D [1:0] bits.

**GON** Set the output level of gate driver G1 ~ G220 as follows

GON	G1~G220 Gate Output
0	VGL
1	Normal display

Description

**CL:** When CL = "1", the ST7775R halt grayscale amplifiers to display 8-color with low power consumption. When setting 8-color display mode, follow the sequence of 8-color display mode setting

CL	Display color
0	262,144
1	8

*Note: When CL = 1, do not write the data corresponding to the grayscales, for which the operation of amplifier is halted.*

**REV:** Enables the grayscale inversion of the image by setting REV = 1. This enables the ST7775R to display the same image from the same set of data whether the liquid crystal panel is normally black or white.

REV	DRAM Data	Non- Display Area	
		Positive Polarity	Negative Polarity
0	18'h00000	V63	V0
	.	.	.
	.	.	.
	.	.	.
1	18'h3FFFF	V0	V63
	18'h00000	V0	V63
	.	.	.
	.	.	.
1	.	.	.
	18'h3FFFF	V63	V0

**TEMON :** TEMON = 1, Enable the Frame flag output signal from the FMARK signal line for preventing Tearing Effect.

TEMON = 0, Disable the Frame flag output signal from the FMARK signal line for preventing Tearing Effect.

9.2.7 Display Control 2 (R08h)

Display Control 2 (R08h)																																		
RS	WRX	RDX	D15	D14	D13	D12	D11	D10	D9	D8	D7	D6	D5	D4	D3	D2	D1	D0																
1	↑	1	0	0	0	0	FP3	FP2	FP1	FP0	0	0	0	0	BP3	BP2	BP1	BP0																
Default value			0	0	0	0	1	0	0	0	0	0	0	0	1	0	0	0																
Description			<p><b>FP [3:0]:</b> Sets the number of lines for a front porch period (a blank period following the end of display).</p> <p><b>BP [3:0]:</b> Sets the number of lines for a back porch period (a blank period made before the beginning of display).</p> <p><i>Note: In 8080 interface operation mode, BP&gt;=2 lines, FP&gt;=2 lines, BP+FP&lt;=16 lines</i></p> <p>In external display interface operation, a back porch (BP) period starts on the falling edge of the FMARK signal and the display operation starts after the back porch period. A blank period will start after a front porch (FP) period and it will continue until next FMARK input is detected.</p>																															
			<table border="1"> <thead> <tr> <th>FP[3:0] BP[3:0]</th> <th>Porch Lines</th> </tr> </thead> <tbody> <tr><td>0000</td><td>Setting Prohibited</td></tr> <tr><td>0001</td><td>Setting Prohibited</td></tr> <tr><td>0010</td><td>2 lines</td></tr> <tr><td>0011</td><td>3 lines</td></tr> <tr><td>0100</td><td>4 lines</td></tr> <tr><td>0101</td><td>5 lines</td></tr> <tr><td>0110</td><td>6 lines</td></tr> <tr><td>0111</td><td>7 lines</td></tr> <tr><td>1000</td><td>8 lines</td></tr> <tr><td>1001</td><td>9 lines</td></tr> <tr><td>1010</td><td>10 lines</td></tr> <tr><td>1011</td><td>11 lines</td></tr> <tr><td>1100</td><td>12 lines</td></tr> <tr><td>1101</td><td>13 lines</td></tr> <tr><td>1110</td><td>14 lines</td></tr> <tr><td>1111</td><td>Setting Prohibited</td></tr> </tbody> </table>	FP[3:0] BP[3:0]	Porch Lines	0000	Setting Prohibited	0001	Setting Prohibited	0010	2 lines	0011	3 lines	0100	4 lines	0101	5 lines	0110	6 lines	0111	7 lines	1000	8 lines	1001	9 lines	1010	10 lines	1011	11 lines	1100	12 lines	1101	13 lines	1110
FP[3:0] BP[3:0]	Porch Lines																																	
0000	Setting Prohibited																																	
0001	Setting Prohibited																																	
0010	2 lines																																	
0011	3 lines																																	
0100	4 lines																																	
0101	5 lines																																	
0110	6 lines																																	
0111	7 lines																																	
1000	8 lines																																	
1001	9 lines																																	
1010	10 lines																																	
1011	11 lines																																	
1100	12 lines																																	
1101	13 lines																																	
1110	14 lines																																	
1111	Setting Prohibited																																	
			<p>Note: The output timing to the LCD is delayed by 2 lines period from the input FMARK signal.</p>																															

Set BP[3:0] and FP[3:0] bits as below for each operation mode				
Operation Mode	Number of Interface Scan Field	BP	FP	BP+FP
8080/6800 System Interface	FLD=0	BP>=2	BP>=2	FP+BP>=16
	FLD=0	BP>=3	BP>=5	
RGB Interface		BP>=2 l	BP>=2	FP+BP>=16
<i>Note: BP and FP unit is lines</i>				

9.2.8 Frame Cycle Control (R0Bh)

Frame Cycle Control (R0Bh)																																																				
RS	WRX	RDX	D15	D14	D13	D12	D11	D10	D9	D8	D7	D6	D5	D4	D3	D2	D1	D0																																		
1	↑	1	0	0	0	0	0	0	0	0	0	0	0	0	RTN3	RTN2	RTN1	RTN0																																		
<b>Default value</b>			0	0	0	0	0	0	0	0	0	0	0	0	0	0	0	0																																		
<b>Description</b>			<p><b>RTNI[3:0]:</b> Sets 1H (line) period. This setting is enabled while the ST7775R's display operation is synchronized with internal clock.</p> <table border="1" style="margin-left: auto; margin-right: auto;"> <thead> <tr> <th>RTN[3:0]</th> <th>Clocks/Line</th> </tr> </thead> <tbody> <tr><td>00h</td><td>0 clock</td></tr> <tr><td>01h</td><td>1 clock</td></tr> <tr><td>02h</td><td>2 clocks</td></tr> <tr><td>03h</td><td>3 clocks</td></tr> <tr><td>04h</td><td>4 clocks</td></tr> <tr><td>05h</td><td>5 clocks</td></tr> <tr><td>06h</td><td>6 clocks</td></tr> <tr><td>07h</td><td>7 clocks</td></tr> <tr><td>08h</td><td>8 clocks</td></tr> <tr><td>09h</td><td>9 clocks</td></tr> <tr><td>0Ah</td><td>10 clocks</td></tr> <tr><td>0Bh</td><td>11 clocks</td></tr> <tr><td>0Ch</td><td>12 clocks</td></tr> <tr><td>0Dh</td><td>13 clocks</td></tr> <tr><td>0Eh</td><td>14 clocks</td></tr> <tr><td>0Fh</td><td>15 clocks</td></tr> </tbody> </table>																RTN[3:0]	Clocks/Line	00h	0 clock	01h	1 clock	02h	2 clocks	03h	3 clocks	04h	4 clocks	05h	5 clocks	06h	6 clocks	07h	7 clocks	08h	8 clocks	09h	9 clocks	0Ah	10 clocks	0Bh	11 clocks	0Ch	12 clocks	0Dh	13 clocks	0Eh	14 clocks	0Fh	15 clocks
			RTN[3:0]	Clocks/Line																																																
			00h	0 clock																																																
			01h	1 clock																																																
			02h	2 clocks																																																
			03h	3 clocks																																																
			04h	4 clocks																																																
			05h	5 clocks																																																
			06h	6 clocks																																																
			07h	7 clocks																																																
			08h	8 clocks																																																
			09h	9 clocks																																																
			0Ah	10 clocks																																																
			0Bh	11 clocks																																																
			0Ch	12 clocks																																																
0Dh	13 clocks																																																			
0Eh	14 clocks																																																			
0Fh	15 clocks																																																			

9.2.9 RGB Display Interface Control 1 (R0Ch)

RGB Display Interface Control 1 (R0Ch)																																																				
RS	WRX	RDX	D15	D14	D13	D12	D11	D10	D9	D8	D7	D6	D5	D4	D3	D2	D1	D0																																		
1	↑	1	0	0	0	0	0	0	0	RM	0	0	0	DM	0	0	RIM1	RIM0																																		
<b>Default value</b>			0	0	0	0	0	0	0	0	0	0	0	0	0	0	0	0																																		
<b>Description</b>	<p><b>RIM [1:0]:</b> Select the RGB interface data format.</p> <table border="1"> <thead> <tr> <th>RIM[1:0]</th> <th>RGB Interface Mode</th> </tr> </thead> <tbody> <tr> <td>00</td> <td>18-bit RGB interface (1 transfer/pixel), DB[17:0]</td> </tr> <tr> <td>01</td> <td>16-bit RGB interface (1 transfer/pixel), DB[17:13] and DB[11:1]</td> </tr> <tr> <td>10</td> <td>6-bit RGB interface (3 transfers/pixel), DB[17:12]</td> </tr> <tr> <td>11</td> <td>Setting disabled</td> </tr> </tbody> </table> <p><i>Note1: Registers are set only by the system interface.</i></p> <p><i>Note2: Be sure that one pixel (3 dots) data transfer finished when interface switch.</i></p> <p><b>DM [1:0]:</b> Select the display operation mode.</p> <table border="1"> <thead> <tr> <th>DM[1:0]</th> <th>Display Interface</th> </tr> </thead> <tbody> <tr> <td>0</td> <td>Internal system clock</td> </tr> <tr> <td>1</td> <td>RGB interface</td> </tr> </tbody> </table> <p><i>Note1: The DM[1:0] setting allows switching between internal clock operation mode and external display interface operation mode. However, switching between the RGB interface operation mode and the VSYNC interface operation mode is prohibited.</i></p> <p><b>RM:</b> Select the interface to access the DRAM.</p> <table border="1"> <thead> <tr> <th>RM</th> <th>Interface FOR DRAM Access</th> </tr> </thead> <tbody> <tr> <td>0</td> <td>Internal system clock interface</td> </tr> <tr> <td>1</td> <td>RGB interface (when writing display data the RGB interface )</td> </tr> </tbody> </table> <table border="1"> <thead> <tr> <th>Display Status</th> <th>Operation Mode</th> <th>RAM Access(RM)</th> <th>Display Operation Mode(DM[1:0])</th> </tr> </thead> <tbody> <tr> <td>Still picture</td> <td>Internal clock operation</td> <td>System interface(RM = 0)</td> <td>Internal clock operation (DM = 0)</td> </tr> <tr> <td>Moving picture</td> <td>RGB interface (1)</td> <td>RGB interface(RM = 1)</td> <td>RGB interface (DM = 1)</td> </tr> </tbody> </table>																		RIM[1:0]	RGB Interface Mode	00	18-bit RGB interface (1 transfer/pixel), DB[17:0]	01	16-bit RGB interface (1 transfer/pixel), DB[17:13] and DB[11:1]	10	6-bit RGB interface (3 transfers/pixel), DB[17:12]	11	Setting disabled	DM[1:0]	Display Interface	0	Internal system clock	1	RGB interface	RM	Interface FOR DRAM Access	0	Internal system clock interface	1	RGB interface (when writing display data the RGB interface )	Display Status	Operation Mode	RAM Access(RM)	Display Operation Mode(DM[1:0])	Still picture	Internal clock operation	System interface(RM = 0)	Internal clock operation (DM = 0)	Moving picture	RGB interface (1)	RGB interface(RM = 1)	RGB interface (DM = 1)
	RIM[1:0]	RGB Interface Mode																																																		
	00	18-bit RGB interface (1 transfer/pixel), DB[17:0]																																																		
	01	16-bit RGB interface (1 transfer/pixel), DB[17:13] and DB[11:1]																																																		
	10	6-bit RGB interface (3 transfers/pixel), DB[17:12]																																																		
	11	Setting disabled																																																		
	DM[1:0]	Display Interface																																																		
	0	Internal system clock																																																		
	1	RGB interface																																																		
	RM	Interface FOR DRAM Access																																																		
0	Internal system clock interface																																																			
1	RGB interface (when writing display data the RGB interface )																																																			
Display Status	Operation Mode	RAM Access(RM)	Display Operation Mode(DM[1:0])																																																	
Still picture	Internal clock operation	System interface(RM = 0)	Internal clock operation (DM = 0)																																																	
Moving picture	RGB interface (1)	RGB interface(RM = 1)	RGB interface (DM = 1)																																																	



	Rewrite still picture area while displaying moving pictures.	RGB interface (2)	System interface(RM = 0)	RGB interface (DM = 1)
<p>Note1: Registers are set only via the system interface or SPI interface.</p> <p>Note2: Refer to the flowcharts of "RGB Input Interface" section for the mode switch.</p>				

9.2.10 Oscillator Control (R0Fh)

Oscillator Control (R0Fh)																								
RS	WRX	RDX	D15	D14	D13	D12	D11	D10	D9	D8	D7	D6	D5	D4	D3	D2	D1	D0						
1	↑	1	0	0	0	0	0	0	0	0	0	0	0	0	0	0	0	OSC_EN						
<b>Default value</b>			0	0	0	0	0	0	0	0	0	0	0	0	0	0	0	1						
<b>Description</b>			<p><b>OSC_EN</b> :This instruction starts the oscillator from the Halt State in the standby mode. After this instruction,Wait at least 10 ms for oscillation to stabilize before giving the next instruction.</p> <table border="1" style="margin-left: 20px;"> <thead> <tr> <th>OSC_EN</th> <th>OSC Control</th> </tr> </thead> <tbody> <tr> <td>0</td> <td>OSC. Off</td> </tr> <tr> <td>1</td> <td>OSC. On</td> </tr> </tbody> </table>																OSC_EN	OSC Control	0	OSC. Off	1	OSC. On
OSC_EN	OSC Control																							
0	OSC. Off																							
1	OSC. On																							

9.2.11 Power Control 1 (R10h)

Power Control 1 (R10h)																		
RS	WRX	RDX	D15	D14	D13	D12	D11	D10	D9	D8	D7	D6	D5	D4	D3	D2	D1	D0
1	↑	1	0	0	0	0	0	0	0	0	0	0	0	0	0	0	SLP	STB
<b>Default value</b>			0	0	0	0	0	0	0	0	0	0	0	0	0	0	0	0
<b>Description</b>			<p><b>SLP</b>: When SLP = "1", ST7775R enters the sleep mode and the display operation stops except the RC oscillator to reduce the power consumption. No change to the DRAM data and instruction setting is accepted and he DRAM data and the instruction setting are maintained in SLP mode.</p> <p><b>STB</b>: When STB = "1", ST7775R enters the standby mode and the display operation stops except the DRAM power supply to reduce the power consumption. No change to the DRAM data and instruction setting is accepted and he DRAM data and the instruction setting are maintained in STB mode.</p>															

9.2.12 Power Control 2 (R11h)

Power Control 2 (R11h)																		
RS	WRX	RDX	D15	D14	D13	D12	D11	D10	D9	D8	D7	D6	D5	D4	D3	D2	D1	D0
1	↑	1	0	0	0	APON	0	0	0	0	0	0	0	0	0	0	0	0
Default value			0	0	0	0	0	0	0	0	0	0	0	0	0	0	0	0
Description			<p><b>APON:</b> This is an automatic-boosting-operation-starting bit for the booster circuits. In case of APON=0, the auto booster sequence circuit is stopped. In case of APON=1, booster circuits are automatically and sequentially operated.</p>															

9.2.13 DRAM Horizontal/Vertical Address Set (R20h, R21h)

DRAM Horizontal/Vertical Address Set (R20h,R21h)																																								
RS	WRX	RDX	D15	D14	D13	D12	D11	D10	D9	D8	D7	D6	D5	D4	D3	D2	D1	D0																						
1	↑	1	0	0	0	0	0	0	0	0	AD7	AD6	AD5	AD4	AD3	AD2	AD1	AD0																						
Default value			0	0	0	0	0	0	0	0	0	0	0	0	0	0	0	0																						
1	↑	1	0	0	0	0	0	0	0	0	AD15	AD14	AD13	AD12	AD11	AD10	AD9	AD8																						
Default value			0	0	0	0	0	0	0	0	0	0	0	0	0	0	0	0																						
Description			<p><b>AD [15:0]:</b>A DRAM address set initially in the AC (Address Counter).The address in the AC is automatically updated according to the combination of AM, I/D[1:0] settings as the ST7775R writes data to the internal DRAM so that data can be written consecutively without resetting the address in the AC.</p> <table border="1" style="margin-left: auto; margin-right: auto;"> <thead> <tr> <th>AD[15:0]</th> <th>DRAM Data Map</th> </tr> </thead> <tbody> <tr> <td>16'h0000~16'h00AF</td> <td>1st line DRAM Data</td> </tr> <tr> <td>16'h0100~16'h01AF</td> <td>2nd line DRAM Data</td> </tr> <tr> <td>16'h0200~16'h02AF</td> <td>3rd line DRAM Data</td> </tr> <tr> <td>16'h0300~16'h03AF</td> <td>4th line DRAM Data</td> </tr> <tr> <td style="text-align: center;">.</td> <td style="text-align: center;">.</td> </tr> <tr> <td style="text-align: center;">.</td> <td style="text-align: center;">.</td> </tr> <tr> <td style="text-align: center;">.</td> <td style="text-align: center;">.</td> </tr> <tr> <td>16'h0900~16'HD8AF</td> <td>218th line DRAM Data</td> </tr> <tr> <td>16'h0A00~16'hDAAF</td> <td>219th line DRAM Data</td> </tr> <tr> <td>16'h0B00~16'hDBAF</td> <td>220h line DRAM Data</td> </tr> </tbody> </table>																AD[15:0]	DRAM Data Map	16'h0000~16'h00AF	1st line DRAM Data	16'h0100~16'h01AF	2nd line DRAM Data	16'h0200~16'h02AF	3rd line DRAM Data	16'h0300~16'h03AF	4th line DRAM Data	.	.	.	.	.	.	16'h0900~16'HD8AF	218th line DRAM Data	16'h0A00~16'hDAAF	219th line DRAM Data	16'h0B00~16'hDBAF	220h line DRAM Data
AD[15:0]	DRAM Data Map																																							
16'h0000~16'h00AF	1st line DRAM Data																																							
16'h0100~16'h01AF	2nd line DRAM Data																																							
16'h0200~16'h02AF	3rd line DRAM Data																																							
16'h0300~16'h03AF	4th line DRAM Data																																							
.	.																																							
.	.																																							
.	.																																							
16'h0900~16'HD8AF	218th line DRAM Data																																							
16'h0A00~16'hDAAF	219th line DRAM Data																																							
16'h0B00~16'hDBAF	220h line DRAM Data																																							

9.2.14 Write Data to DRAM (R22h)

Write Data to DRAM (R22h)																		
RS	WRX	RDX	D15	D14	D13	D12	D11	D10	D9	D8	D7	D6	D5	D4	D3	D2	D1	D0
1	↑	1	WD [17:0] - DRAM Write Data															
<b>Description</b>			<p><b>WD [17:0]:</b> The ST7775R develops data into 18 bits internally in write operation. The format to develop data into 18 bits is different in different interface operation. The DRAM data represents the grayscale level. The DRAM data represents the grayscale level. ST7775R automatically updates the address to the begin point according to AM and I/D[1:0] settings as it's wrote this register. The DFM bit sets the format to develop 16-bit data into the 18-bit data in 16-bit or 8-bit interface operation.</p>															

Preliminary

9.2.15 Read Data from DRAM (R22h)

Read Data from DRAM (R22h)																		
RS	WRX	RDX	D15	D14	D13	D12	D11	D10	D9	D8	D7	D6	D5	D4	D3	D2	D1	D0
1	1	↑	RD [17:0] - DRAM Read Data															
<b>Description</b>			<p><b>RD [17:0]:</b> 18-bit data read from the DRAM. RAM read data RD [17:0] is transferred via different data bus in different interface operation. When the ST7775R reads data from the DRAM to the microcomputer, the first word read immediately after RAM address set is executed is taken in the internal read-data latch and invalid data is sent to the data bus. Valid data is sent to the data bus when the ST7775R reads out the second and subsequent words. When either 8-bit or 16-bit interface is selected, the LSBs of R and B dot data are not read out.</p>															
			<pre> graph TD     A[Set I/D AM, HAS /HEA, VSA/VEA] --&gt; B[Set Address M]     B --&gt; C["Dummy Read (Invalid Data) DRAM -&gt; Read Data Latch"]     C --&gt; D["Read Output (Data of Address M) Read Data Latch -&gt; DB[17: 0]"]     D --&gt; E["Read Output (Data of Address M+1) Read Data Latch -&gt; DB[17: 0]"]     E --&gt; F[Set Address N]     F --&gt; G["Dummy Read (Invalid Data) DRAM -&gt; Read Data Latch"]     G --&gt; H["Read Output (Data of Address N) Read Data Latch -&gt; DB[17: 0]"]     H --&gt; I[ ]     style I fill:none,stroke:none     </pre> <p>The ST7775R also support function that automatically updates the address according to AM and I/D[1:0] settings as it read data continuously address in the DRAM</p>															

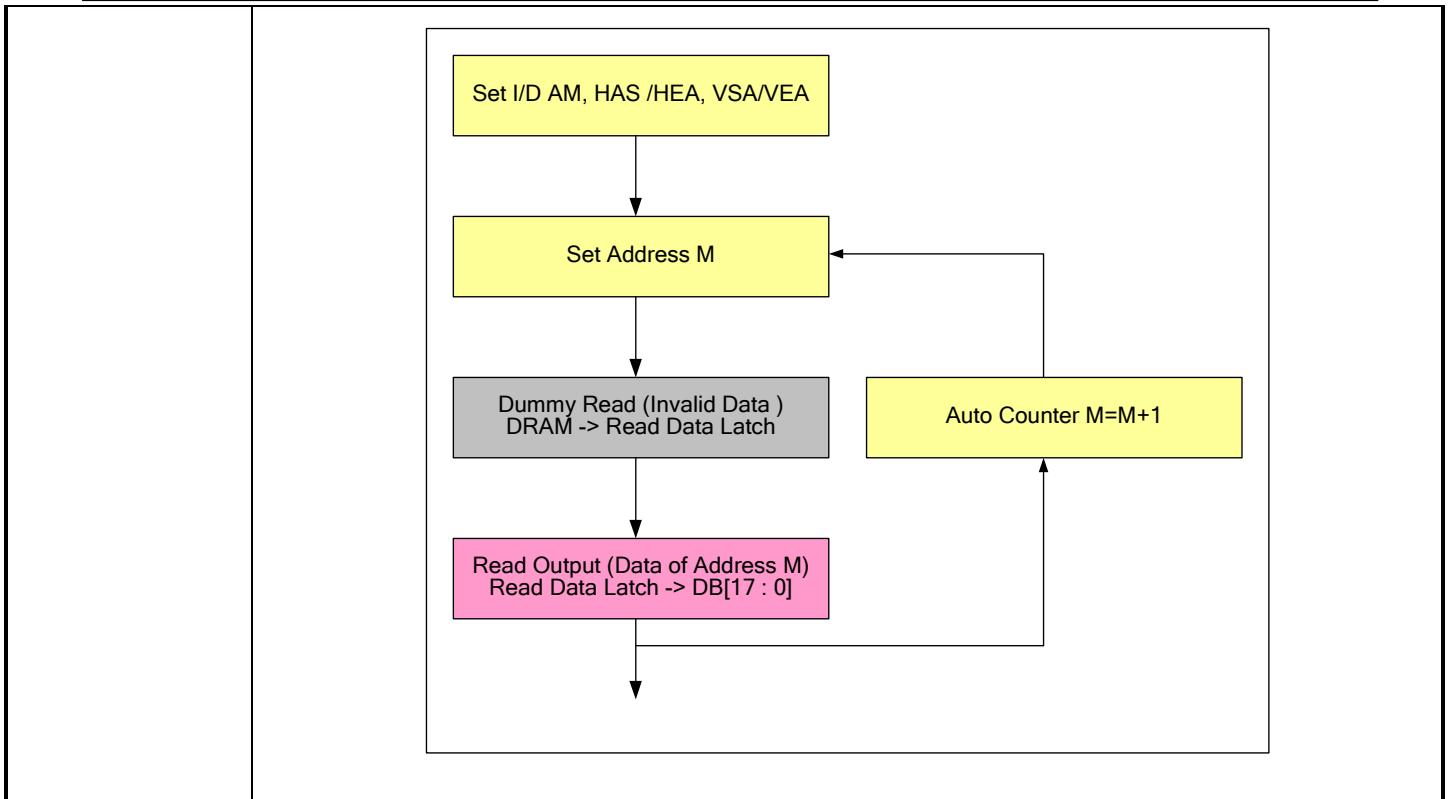

9.2.16 Software Reset (R28h)

Software Reset (R28h)																		
RS	WRX	RDX	D15	D14	D13	D12	D11	D10	D9	D8	D7	D6	D5	D4	D3	D2	D1	D0
1	↑	1	0	0	0	0	0	0	0	0	1	1	0	0	1	1	1	0
<b>Description</b>			When Software Reset parameter is 00CEh, It cause a software reset. This register automatically set to Zero after a Software Reset.															

9.2.17 Gate Scan Control (R30h)

Gate Scan Control (R30h)																																																																																																																																																												
RS	WRX	RDX	D15	D14	D13	D12	D11	D10	D9	D8	D7	D6	D5	D4	D3	D2	D1	D0																																																																																																																																										
1	↑	1	0	0	0	0	0	0	0	0	0	0	0	0	SCN4	SCN3	SCN2	SCN1	SCN0																																																																																																																																									
Default value			0	0	0	0	0	0	0	0	0	0	0	0	0	0	0	0	0																																																																																																																																									
Description			<p><b>SCN [4:0]:</b> Specifies the gate line where the gate driver starts scan.</p> <table border="1"> <thead> <tr> <th rowspan="3">SCN[4:0]</th> <th colspan="4">Scanning Start Position</th> </tr> <tr> <th colspan="2">SM=0</th> <th colspan="2">SM=1</th> </tr> <tr> <th>GS=0</th> <th>GS=1</th> <th>GS=0</th> <th>GS=1</th> </tr> </thead> <tbody> <tr><td>00h</td><td>G1</td><td>G220</td><td>G1</td><td>G220</td></tr> <tr><td>01h</td><td>G9</td><td>G212</td><td>G17</td><td>G204</td></tr> <tr><td>02h</td><td>G17</td><td>G204</td><td>G33</td><td>G188</td></tr> <tr><td>03h</td><td>G25</td><td>G296</td><td>G49</td><td>G172</td></tr> <tr><td>04h</td><td>G33</td><td>G188</td><td>G65</td><td>G165</td></tr> <tr><td>05h</td><td>G41</td><td>G180</td><td>G81</td><td>G140</td></tr> <tr><td>06h</td><td>G49</td><td>G172</td><td>G97</td><td>G124</td></tr> <tr><td>07h</td><td>G57</td><td>G164</td><td>G113</td><td>G108</td></tr> <tr><td>08h</td><td>G65</td><td>G156</td><td>G129</td><td>G92</td></tr> <tr><td>09h</td><td>G73</td><td>G148</td><td>G145</td><td>G76</td></tr> <tr><td>0Ah</td><td>G81</td><td>G140</td><td>G161</td><td>G60</td></tr> <tr><td>0Bh</td><td>G89</td><td>G132</td><td>G177</td><td>G44</td></tr> <tr><td>0Ch</td><td>G97</td><td>G124</td><td>G193</td><td>G28</td></tr> <tr><td>0Dh</td><td>G105</td><td>G116</td><td>G209</td><td>G12</td></tr> <tr><td>0Eh</td><td>G113</td><td>G108</td><td>G2</td><td>G219</td></tr> <tr><td>0Fh</td><td>G121</td><td>G100</td><td>G18</td><td>G203</td></tr> <tr><td>10h</td><td>G129</td><td>G92</td><td>G34</td><td>G187</td></tr> <tr><td>11h</td><td>G137</td><td>G84</td><td>G50</td><td>G171</td></tr> <tr><td>12h</td><td>G145</td><td>G76</td><td>G66</td><td>G155</td></tr> <tr><td>13h</td><td>G153</td><td>G68</td><td>G82</td><td>G139</td></tr> <tr><td>14h</td><td>G161</td><td>G60</td><td>G98</td><td>G123</td></tr> <tr><td>15h</td><td>G169</td><td>G52</td><td>G114</td><td>G107</td></tr> <tr><td>16h</td><td>G177</td><td>G44</td><td>G130</td><td>G91</td></tr> <tr><td>17h</td><td>G185</td><td>G36</td><td>G146</td><td>G75</td></tr> <tr><td>18h</td><td>G193</td><td>G28</td><td>G162</td><td>G59</td></tr> </tbody> </table>																SCN[4:0]	Scanning Start Position				SM=0		SM=1		GS=0	GS=1	GS=0	GS=1	00h	G1	G220	G1	G220	01h	G9	G212	G17	G204	02h	G17	G204	G33	G188	03h	G25	G296	G49	G172	04h	G33	G188	G65	G165	05h	G41	G180	G81	G140	06h	G49	G172	G97	G124	07h	G57	G164	G113	G108	08h	G65	G156	G129	G92	09h	G73	G148	G145	G76	0Ah	G81	G140	G161	G60	0Bh	G89	G132	G177	G44	0Ch	G97	G124	G193	G28	0Dh	G105	G116	G209	G12	0Eh	G113	G108	G2	G219	0Fh	G121	G100	G18	G203	10h	G129	G92	G34	G187	11h	G137	G84	G50	G171	12h	G145	G76	G66	G155	13h	G153	G68	G82	G139	14h	G161	G60	G98	G123	15h	G169	G52	G114	G107	16h	G177	G44	G130	G91	17h	G185	G36	G146	G75	18h	G193	G28	G162	G59
			SCN[4:0]	Scanning Start Position																																																																																																																																																								
				SM=0		SM=1																																																																																																																																																						
				GS=0	GS=1	GS=0	GS=1																																																																																																																																																					
			00h	G1	G220	G1	G220																																																																																																																																																					
			01h	G9	G212	G17	G204																																																																																																																																																					
			02h	G17	G204	G33	G188																																																																																																																																																					
			03h	G25	G296	G49	G172																																																																																																																																																					
			04h	G33	G188	G65	G165																																																																																																																																																					
			05h	G41	G180	G81	G140																																																																																																																																																					
			06h	G49	G172	G97	G124																																																																																																																																																					
			07h	G57	G164	G113	G108																																																																																																																																																					
			08h	G65	G156	G129	G92																																																																																																																																																					
			09h	G73	G148	G145	G76																																																																																																																																																					
			0Ah	G81	G140	G161	G60																																																																																																																																																					
			0Bh	G89	G132	G177	G44																																																																																																																																																					
			0Ch	G97	G124	G193	G28																																																																																																																																																					
			0Dh	G105	G116	G209	G12																																																																																																																																																					
			0Eh	G113	G108	G2	G219																																																																																																																																																					
			0Fh	G121	G100	G18	G203																																																																																																																																																					
10h	G129	G92	G34	G187																																																																																																																																																								
11h	G137	G84	G50	G171																																																																																																																																																								
12h	G145	G76	G66	G155																																																																																																																																																								
13h	G153	G68	G82	G139																																																																																																																																																								
14h	G161	G60	G98	G123																																																																																																																																																								
15h	G169	G52	G114	G107																																																																																																																																																								
16h	G177	G44	G130	G91																																																																																																																																																								
17h	G185	G36	G146	G75																																																																																																																																																								
18h	G193	G28	G162	G59																																																																																																																																																								

	19h	G201	G20	G178	G43
	1Ah	G209	G12	G194	G27
	1Bh	G217	G4	G210	G11

9.2.18 Vertical Scroll Control1 (R31h,R32h)

Vertical Scroll Control (R31h,R32h)																				
R31h	RS	WRX	RDX	D15	D14	D13	D12	D11	D10	D9	D8	D7	D6	D5	D4	D3	D2	D1	D0	
	1	↑	1	0	0	0	0	0	0	0	0	SEA7	SEA6	SEA5	SEA4	SEA3	SEA2	SEA1	SEA0	
<b>Default value</b>				0	0	0	0	0	0	0	0	1	1	0	1	1	0	1	1	
R32h	RS	WRX	RDX	D15	D14	D13	D12	D11	D10	D9	D8	D7	D6	D5	D4	D3	D2	D1	D0	
	1	↑	1	0	0	0	0	0	0	0	0	SSA7	SSA6	SSA5	SSA4	SSA3	SSA2	SSA1	SSA0	
<b>Default value</b>				0	0	0	0	0	0	0	0	0	0	0	0	0	0	0	0	0
<b>Description</b>	<b>SSA [7:0]:</b> Specify scroll start address at the scroll display for vertical smooth scrolling.																			
	<b>SSA[7:0]</b>												<b>Scroll Start Lines</b>							
	00h												0 line							
	01h												1 line							
	02h												2 lines							
	03h												3 lines							
	.												.							
	.												.							
	.												.							
	D9h												217 lines							
	DAh												218 lines							
	DBh												219 lines							
	<b>SEA[7:0]:</b> Specify scroll end address at the scroll display for vertical smooth scrolling.																			
	<b>SEA[7:0]</b>												<b>Scroll End Lines</b>							
	00h												0 line							
01h												1 line								
02h												2 lines								
03h												3 lines								
.												.								
.												.								

.	.
D9h	217 lines
DAh	218 lines
DBh	219 lines

Note1 : Do not set any higher raster-row than 219 ("DB"H).

Note2 : Set SS17-10 \_ SSA7-0, if set out of range, SSA7-0 = SS17-10.

Note3 : Set SE17-10 \_ SEA7-0, if set out of range, SEA7-0 = SE17-10

9.2.19 Vertical Scroll Control1 (R33h)

Vertical Scroll Control 1(R33h)																		
RS	WRX	RDX	D15	D14	D13	D12	D11	D10	D9	D8	D7	D6	D5	D4	D3	D2	D1	D0
1	↑	1	0	0	0	0	0	0	0	0	SST7	SST6	SST5	SST4	SST3	SST2	SST1	SST0
<b>Default value</b>			0	0	0	0	0	0	0	0	0	0	0	0	0	0	0	0
<b>Description</b>			SST [7:0]: Specify scroll start and step at the scroll display for vertical smooth scrolling. Any line from the 1st to 220th can be scrolled for the number of the raster-row. After 219th line is displayed, the display restarts from the first raster-row. When SST [7:0] = 00000000, Vertical Scroll Function is disabled.															
			<b>SST[7:0]</b>		<b>Scrolling Lines</b>													
			00h		0 line													
			01h		1 line													
			02h		2 lines													
			03h		3 lines													
			.		.													
			.		.													
			.		.													
			D9h		217 lines													
DAh		218 lines																
DBh		219 lines																
<b>Note:</b>			<p>1. Do not set any higher raster-row than 219 ("DB"H)</p> <p>2. Set SS17-10 &lt; SSA7-0 + SST7-0 _ SEA7-0 _ SE17-10, if set out of range, Scroll function is disabled</p>															



9.2.20 Partial Screen Driving Position (R34h,R35h)

Partial Screen Driving Position (R34h,R35h)																				
R31h	RS	WRX	RDX	D15	D14	D13	D12	D11	D10	D9	D8	D7	D6	D5	D4	D3	D2	D1	D0	
	1	↑	1	0	0	0	0	0	0	0	0	SE17	SE16	SE15	SE14	SE13	SE12	SE11	SE10	
Default value				0	0	0	0	0	0	0	0	1	1	0	1	1	0	1	1	
R32h	RS	WRX	RDX	D15	D14	D13	D12	D11	D10	D9	D8	D7	D6	D5	D4	D3	D2	D1	D0	
	1	↑	1	0	0	0	0	0	0	0	0	SS17	SS16	SS15	SS14	SS13	SS12	SS11	SS10	
Default value				0	0	0	0	0	0	0	0	0	0	0	0	0	0	0	0	0
Description				<p><b>SE1 [7:0]:</b> Specify the driving end position for the screen in a line unit. The LCD driving is performed to the 'set value + 1' gate driver. For example, when SS1[7:0] = 019h and SE1[7:0] = 029h are set, the LCD driving is performed from G26 to G42, and non-display driving is performed for G1 to G25, G43, and others. Ensure that SS1[7:0] &lt;=SE1[7:0]&lt;=DBh.</p> <p><b>SS1 [7:0]:</b> Specify the drive starting position for the first screen in a line unit. The LCD driving starts from the 'set value +1' gate driver.</p> <p><i>Note: Do not set the partial setting when the operation is in the normal display condition. Set this register only when in the partial display condition.</i></p>																

9.2.21 Horizontal and Vertical RAM Address Position (R36h, R37h, R38h, R39h)

Horizontal and Vertical RAM Address Position(R36h,R37h,R38h,R39h)																				
R36h	RS	WRX	RDX	D15	D14	D13	D12	D11	D10	D9	D8	D7	D6	D5	D4	D3	D2	D1	D0	
	1	↑	1	0	0	0	0	0	0	0	0	HEA7	HEA6	HEA5	HEA4	HEA3	HEA2	HEA1	HEA0	
Default value				0	0	0	0	0	0	0	0	1	0	1	0	1	1	1	1	
R37h	RS	WRX	RDX	D15	D14	D13	D12	D11	D10	D9	D8	D7	D6	D5	D4	D3	D2	D1	D0	
	1	↑	1	0	0	0	0	0	0	0	0	HSA7	HSA6	HSA5	HSA4	HSA3	HSA2	HSA1	HSA0	
Default value				0	0	0	0	0	0	0	0	0	0	0	0	0	0	0	0	0
R38h	RS	WRX	RDX	D15	D14	D13	D12	D11	D10	D9	D8	D7	D6	D5	D4	D3	D2	D1	D0	
	1	↑	1	0	0	0	0	0	0	0	0	VEA7	VEA6	VEA5	VEA4	VEA3	VEA2	VEA1	VEA0	
Default value				0	0	0	0	0	0	0	0	1	1	0	1	1	0	1	1	
R39h	RS	WRX	RDX	D15	D14	D13	D12	D11	D10	D9	D8	D7	D6	D5	D4	D3	D2	D1	D0	
	1	↑	1	0	0	0	0	0	0	0	0	VSA7	VSA6	VSA5	VSA4	VSA3	VSA2	VSA1	VSA0	
Default value				0	0	0	0	0	0	0	0	0	0	0	0	0	0	0	0	0

**Description**

**HSA [7:0], HEA [7:0]** HSA[7:0] and HEA[7:0] are the start and end addresses of the window address area in horizontal direction, respectively. HSA [7:0] and HEA [7:0] specify the horizontal range to write data. Set HSA [7:0] and HEA [7:0] before starting RAM write operation. In setting, make sure that  $8'h00 \leq HSA < HEA \leq 8'hAF$

**VSA [7:0], VEA [7:0]** VSA [7:0] and VEA [7:0] are the start and end addresses of the window address area in vertical direction, respectively. VSA [7:0] and VEA [7:0] specify the vertical range to write data. Set VSA [7:0] and VEA [7:0] before starting RAM write operation. In setting, make sure that  $9'h000 \leq VSA < VEA \leq 8'hDB$ .

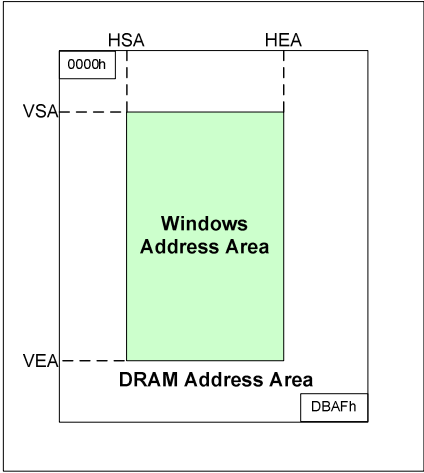

“00”h  $\leq$  HSA[7:0]  $\leq$  HEA[7:0]  $\leq$  “AF”h  
 “00”h  $\leq$  VSA[7:0]  $\leq$  VEA[7:0]  $\leq$  “DB”h

*Note1. The window address range must be within the DRAM address space.  
 Note2. Data are written to DRAM in four-words when operating in high speed mode, the dummy write operations should be inserted depending on the window address area.*

9.2.22 Gamma Control (R50h~R59h)

Gamma Control (R50h~R59h)																			
	RS	WRX	RDX	D15	D14	D13	D12	D11	D10	D9	D8	D7	D6	D5	D4	D3	D2	D1	D0
R50h	1	↑	1	0	0	0	0	0	KP1[2]	KP1[1]	KP1[0]	0	0	0	0	0	KP0[2]	KP0[1]	KP0[0]
Default value				0	0	0	0	0	0	0	0	0	0	0	0	0	0	0	0
R51h	1	↑	1	0	0	0	0	KP3[3]	KP3[2]	KP3[1]	KP3[0]	0	0	0	0	KP2[3]	KP2[2]	KP2[1]	KP2[0]
Default value				0	0	0	0	0	0	0	0	0	0	0	0	0	0	0	0
R52h	1	↑	1	0	0	0	0	0	KP5[2]	KP5[1]	KP5[0]	0	0	0	0	KP4[3]	KP4[2]	KP4[1]	KP4[0]
Default value				0	0	0	0	0	0	0	0	0	0	0	0	0	0	0	0
R53h	1	↑	1	0	0	SELV 63P[2]	SELV 63P[1]	SELV 63P[0]	SELV 62P[2]	SELV 62P[1]	SELV 62P[0]	SELV1 P[3]	SELV1 P[2]	SELV1 P[1]	SELV1 P[0]	SELV0 P[3]	SELV0 P[2]	SELV0 P[1]	SELV0 P[0]
Default value				0	0	0	0	0	0	0	0	0	0	0	0	0	0	0	0
R54h	1	↑	1	0	0	0	0	VOS0 P[3]	VOS0 P[2]	VOS0 P[1]	VOS0 P[0]	0	0	0	0	VRF0 P[3]	VRF0 P[2]	VRF0 P[1]	VRF0 P[0]
Default value				0	0	0	0	0	0	0	0	0	0	0	0	0	0	0	0

R55h	1	↑	1	0	0	0	0	0	KN1 [2]	KN1 [1]	KN1 [0]	0	0	0	0	0	KN0 [2]	KN0 [1]	KN0 [0]		
<b>Default value</b>				0	0	0	0	0	0	0	0	0	0	0	0	0	0	0	0		
R56h	1	↑	1	0	0	0	0	0	KN3 [3]	KN3 [2]	KN3 [1]	KN3 [0]	0	0	0	0	KN2 [3]	KN2 [2]	KN2 [1]	KN2 [0]	
<b>Default value</b>				0	0	0	0	0	0	0	0	0	0	0	0	0	0	0	0	0	
R57h	1	↑	1	0	0	0	0	0	KN5[2]	KN5[1]	KN5[0]	0	0	0	0	0	PKN4 [3]	PKN4 [2]	PKN4 [1]	PKN4 [0]	
<b>Default value</b>				0	0	0	0	0	0	0	0	0	0	0	0	0	0	0	0	0	0
R58h	1	↑	1	0	0	SELV 63N[2]	SELV 63N[1]	SELV 63N[0]	SELV 62N[2]	SELV 62N[1]	SELV 62N[0]	SELV1 N[3]	SELV1 N[2]	SELV1 N[1]	SELV1 N[0]	SELV0 N[3]	SELV0 N[2]	SELV0 N[1]	SELV0 N[0]		
<b>Default value</b>				0	0	0	0	0	0	0	0	0	0	0	0	0	0	0	0	0	
R59h	1	↑	1	0	0	0	0	VOS0 N[3]	VOS0 N[2]	VOS0 N[1]	VOS0 N[0]	0	0	0	0	0	VRF0 N[3]	VRF0 N[2]	VRF0 N[1]	VRF0 N[0]	
<b>Default value</b>				0	0	0	0	0	0	0	0	0	0	0	0	0	0	0	0	0	
<b>Description</b>				<p><b>KP5-0[2:0]:</b> γfine Adjustment Register for Positive Polarity.</p> <p><b>RP1-0[2:0]:</b> γgradient Adjustment Register for Positive Polarity.</p> <p><b>VRP1 [4:0]:</b> γamplitude Adjustment Register for Positive Polarity.</p> <p><b>VRP0 [3:0]:</b> γamplitude Adjustment Register for Positive Polarity.</p> <p><b>KN5-0[2:0]:</b> γfine Adjustment Register for Negative Polarity.</p> <p><b>RN1-0[2:0]:</b> γgradient Adjustment Register for Negative Polarity.</p> <p><b>VRN1 [4:0]:</b> γamplitude Adjustment Register for Negative Polarity.</p> <p><b>VRN0 [3:0]:</b> γamplitude Adjustment Register for Negative Polarity.</p>																	

9.2.23 ID Code(R65h, Read Only)

Read ID Code (R65h)																		
RS	WRX	RDX	D15	D14	D13	D12	D11	D10	D9	D8	D7	D6	D5	D4	D3	D2	D1	D0
1	1	↑	0	0	0	0	0	0	0	0	0	0	0	0	ID3	ID2	ID1	ID0
Default value			0	0	0	0	0	0	0	0	0	0	0	0	0	0	0	0
Description			ID[3:0] This ID code is store in the NV memory to record the LCM vendor code( read only).															

9.2.24 SPI Read/Write Control(R66h)

SPI Read/Write Control (R66h)																								
RS	WRX	RDX	D15	D14	D13	D12	D11	D10	D9	D8	D7	D6	D5	D4	D3	D2	D1	D0						
1	↑	1	0	0	0	0	0	0	0	0	0	0	0	0	0	0	0	R/WX						
Default value			0	0	0	0	0	0	0	0	0	0	0	0	0	0	0	0						
Description			<p>R/WX: This register is used to control the read/write function of registers when the 8/9-bit serial interface is used. If users need to read back the register data by the 8/9-bit serial interface, the R/WX bit must be set as '1'.</p> <table border="1" style="margin-left: 40px;"> <thead> <tr> <th>R/WX</th> <th>Description</th> </tr> </thead> <tbody> <tr> <td>0</td> <td>Register Write Mode (default)</td> </tr> <tr> <td>1</td> <td>Register Read Mode</td> </tr> </tbody> </table>																R/WX	Description	0	Register Write Mode (default)	1	Register Read Mode
R/WX	Description																							
0	Register Write Mode (default)																							
1	Register Read Mode																							

9.2.25 Power Control 2 (RB0h)

Power Control 2 (RB0h)																																																																																																																																									
RS	WRX	RDX	D15	D14	D13	D12	D11	D10	D9	D8	D7	D6	D5	D4	D3	D2	D1	D0																																																																																																																							
1	↑	1	0	0	VCM5	VCM4	VCM3	VCM2	VCM1	VCM0	0	0	VGLSEL1	VGLSEL0	0	0	VGHBT1	VGHBT0																																																																																																																							
<b>Default value</b>			0	0	0	0	1	0	0	0	0	0	0	1	0	0	0	1																																																																																																																							
<p><b>VCM [5:0]: VCOM voltage setting</b></p> <table border="1"> <thead> <tr> <th>VCM[5:0]</th> <th>VCOM</th> <th>VCM[5:0]</th> <th>VCOM</th> </tr> </thead> <tbody> <tr><td>000000</td><td>-0.425</td><td>100000</td><td>-1.225</td></tr> <tr><td>000001</td><td>-0.45</td><td>100001</td><td>-1.25</td></tr> <tr><td>000010</td><td>-0.475</td><td>100010</td><td>-1.275</td></tr> <tr><td>000011</td><td>-0.5</td><td>100011</td><td>-1.3</td></tr> <tr><td>000100</td><td>-0.525</td><td>100100</td><td>-1.325</td></tr> <tr><td>000101</td><td>-0.55</td><td>100101</td><td>-1.35</td></tr> <tr><td>000110</td><td>-0.575</td><td>100110</td><td>-1.375</td></tr> <tr><td>000111</td><td>-0.6</td><td>100111</td><td>-1.4</td></tr> <tr><td>001000</td><td>-0.625</td><td>101000</td><td>-1.425</td></tr> <tr><td>001001</td><td>-0.65</td><td>101001</td><td>-1.45</td></tr> <tr><td>001010</td><td>-0.675</td><td>101010</td><td>-1.475</td></tr> <tr><td>001011</td><td>-0.7</td><td>101011</td><td>-1.5</td></tr> <tr><td>001100</td><td>-0.725</td><td>101100</td><td>-1.525</td></tr> <tr><td>001101</td><td>-0.75</td><td>101101</td><td>-1.55</td></tr> <tr><td>001110</td><td>-0.775</td><td>101110</td><td>-1.575</td></tr> <tr><td>001111</td><td>-0.8</td><td>101111</td><td>-1.6</td></tr> <tr><td>010000</td><td>-0.825</td><td>110000</td><td>-1.625</td></tr> <tr><td>010001</td><td>-0.85</td><td>110001</td><td>-1.65</td></tr> <tr><td>010010</td><td>-0.875</td><td>110010</td><td>-1.675</td></tr> <tr><td>010011</td><td>-0.9</td><td>110011</td><td>-1.7</td></tr> <tr><td>010100</td><td>-0.925</td><td>110100</td><td>-1.725</td></tr> <tr><td>010101</td><td>-0.95</td><td>110101</td><td>-1.75</td></tr> <tr><td>010110</td><td>-0.975</td><td>110110</td><td>-1.775</td></tr> <tr><td>010111</td><td>-1</td><td>110111</td><td>-1.8</td></tr> <tr><td>011000</td><td>-1.025</td><td>111000</td><td>-1.825</td></tr> <tr><td>011001</td><td>-1.05</td><td>111001</td><td>-1.85</td></tr> <tr><td>011010</td><td>-1.075</td><td>111010</td><td>-1.875</td></tr> <tr><td>011011</td><td>-1.1</td><td>111011</td><td>-1.9</td></tr> <tr><td>011100</td><td>-1.125</td><td>111100</td><td>-1.925</td></tr> </tbody> </table>																		VCM[5:0]	VCOM	VCM[5:0]	VCOM	000000	-0.425	100000	-1.225	000001	-0.45	100001	-1.25	000010	-0.475	100010	-1.275	000011	-0.5	100011	-1.3	000100	-0.525	100100	-1.325	000101	-0.55	100101	-1.35	000110	-0.575	100110	-1.375	000111	-0.6	100111	-1.4	001000	-0.625	101000	-1.425	001001	-0.65	101001	-1.45	001010	-0.675	101010	-1.475	001011	-0.7	101011	-1.5	001100	-0.725	101100	-1.525	001101	-0.75	101101	-1.55	001110	-0.775	101110	-1.575	001111	-0.8	101111	-1.6	010000	-0.825	110000	-1.625	010001	-0.85	110001	-1.65	010010	-0.875	110010	-1.675	010011	-0.9	110011	-1.7	010100	-0.925	110100	-1.725	010101	-0.95	110101	-1.75	010110	-0.975	110110	-1.775	010111	-1	110111	-1.8	011000	-1.025	111000	-1.825	011001	-1.05	111001	-1.85	011010	-1.075	111010	-1.875	011011	-1.1	111011	-1.9	011100	-1.125	111100	-1.925
VCM[5:0]	VCOM	VCM[5:0]	VCOM																																																																																																																																						
000000	-0.425	100000	-1.225																																																																																																																																						
000001	-0.45	100001	-1.25																																																																																																																																						
000010	-0.475	100010	-1.275																																																																																																																																						
000011	-0.5	100011	-1.3																																																																																																																																						
000100	-0.525	100100	-1.325																																																																																																																																						
000101	-0.55	100101	-1.35																																																																																																																																						
000110	-0.575	100110	-1.375																																																																																																																																						
000111	-0.6	100111	-1.4																																																																																																																																						
001000	-0.625	101000	-1.425																																																																																																																																						
001001	-0.65	101001	-1.45																																																																																																																																						
001010	-0.675	101010	-1.475																																																																																																																																						
001011	-0.7	101011	-1.5																																																																																																																																						
001100	-0.725	101100	-1.525																																																																																																																																						
001101	-0.75	101101	-1.55																																																																																																																																						
001110	-0.775	101110	-1.575																																																																																																																																						
001111	-0.8	101111	-1.6																																																																																																																																						
010000	-0.825	110000	-1.625																																																																																																																																						
010001	-0.85	110001	-1.65																																																																																																																																						
010010	-0.875	110010	-1.675																																																																																																																																						
010011	-0.9	110011	-1.7																																																																																																																																						
010100	-0.925	110100	-1.725																																																																																																																																						
010101	-0.95	110101	-1.75																																																																																																																																						
010110	-0.975	110110	-1.775																																																																																																																																						
010111	-1	110111	-1.8																																																																																																																																						
011000	-1.025	111000	-1.825																																																																																																																																						
011001	-1.05	111001	-1.85																																																																																																																																						
011010	-1.075	111010	-1.875																																																																																																																																						
011011	-1.1	111011	-1.9																																																																																																																																						
011100	-1.125	111100	-1.925																																																																																																																																						
<b>Description</b>																																																																																																																																									

011101	-1.15	111101	-1.95
011110	-1.175	111110	-1.975
011111	-1.2	111111	-2

**VGLSEL [1:0]:** Set the VGH and VGL supply power level.

VGLSEL[1:0]	VGL
00	-7.5
01	-10
10	-12.5
11	-13

**VGHBT [1:0]:** Set the VGH and VGL supply power level.

VGHBT[1:0]	VGH
00	2*AVDD+VDD
01	3*AVDD
10	3*AVDD+VDD
11	4*AVDD

Preliminary

9.2.26 Power Control 3 (RB1h)

Power Control 3 (RB1h)																																																																																																																																									
RS	WRX	RDX	D15	D14	D13	D12	D11	D10	D9	D8	D7	D6	D5	D4	D3	D2	D1	D0																																																																																																																							
1	↑	1	0	0	0	VRHN4	VRHN3	VRHN2	VRHN1	VRHN0	0	0	0	VRHP4	VRHP3	VRHP2	VRHP1	VRHP0																																																																																																																							
<b>Default value</b>			0	0	0	0	0	0	1	0	0	0	0	0	0	0	1	0																																																																																																																							
<p><b>Description</b></p> <p><b>VRHN/VRHP [4:0]: GVCL/GVDD voltage setting</b></p> <table border="1"> <thead> <tr> <th>VRHN[4:0]</th> <th>GVCL</th> <th>VRHP[4:0]</th> <th>GVDD</th> </tr> </thead> <tbody> <tr><td>00000</td><td>-4.7</td><td>00000</td><td>4.7</td></tr> <tr><td>00001</td><td>-4.65</td><td>00001</td><td>4.65</td></tr> <tr><td>00010</td><td>-4.6</td><td>00010</td><td>4.6</td></tr> <tr><td>00011</td><td>-4.55</td><td>00011</td><td>4.55</td></tr> <tr><td>00100</td><td>-4.5</td><td>00100</td><td>4.5</td></tr> <tr><td>00101</td><td>-4.45</td><td>00101</td><td>4.45</td></tr> <tr><td>00110</td><td>-4.4</td><td>00110</td><td>4.4</td></tr> <tr><td>00111</td><td>-4.35</td><td>00111</td><td>4.35</td></tr> <tr><td>01000</td><td>-4.3</td><td>01000</td><td>4.3</td></tr> <tr><td>01001</td><td>-4.25</td><td>01001</td><td>4.25</td></tr> <tr><td>01010</td><td>-4.2</td><td>01010</td><td>4.2</td></tr> <tr><td>01011</td><td>-4.15</td><td>01011</td><td>4.15</td></tr> <tr><td>01100</td><td>-4.1</td><td>01100</td><td>4.1</td></tr> <tr><td>01101</td><td>-4.05</td><td>01101</td><td>4.05</td></tr> <tr><td>01110</td><td>-4</td><td>01110</td><td>4</td></tr> <tr><td>01111</td><td>-3.95</td><td>01111</td><td>3.95</td></tr> <tr><td>10000</td><td>-3.9</td><td>10000</td><td>3.9</td></tr> <tr><td>10001</td><td>-3.85</td><td>10001</td><td>3.85</td></tr> <tr><td>10010</td><td>-3.8</td><td>10010</td><td>3.8</td></tr> <tr><td>10011</td><td>-3.75</td><td>10011</td><td>3.75</td></tr> <tr><td>10100</td><td>-3.7</td><td>10100</td><td>3.7</td></tr> <tr><td>10101</td><td>-3.65</td><td>10101</td><td>3.65</td></tr> <tr><td>10110</td><td>-3.6</td><td>10110</td><td>3.6</td></tr> <tr><td>10111</td><td>-3.55</td><td>10111</td><td>3.55</td></tr> <tr><td>11000</td><td>-3.5</td><td>11000</td><td>3.5</td></tr> <tr><td>11001</td><td>-3.45</td><td>11001</td><td>3.45</td></tr> <tr><td>11010</td><td>-3.4</td><td>11010</td><td>3.4</td></tr> <tr><td>11011</td><td>-3.35</td><td>11011</td><td>3.35</td></tr> <tr><td>11100</td><td>-3.3</td><td>11100</td><td>3.3</td></tr> </tbody> </table>																		VRHN[4:0]	GVCL	VRHP[4:0]	GVDD	00000	-4.7	00000	4.7	00001	-4.65	00001	4.65	00010	-4.6	00010	4.6	00011	-4.55	00011	4.55	00100	-4.5	00100	4.5	00101	-4.45	00101	4.45	00110	-4.4	00110	4.4	00111	-4.35	00111	4.35	01000	-4.3	01000	4.3	01001	-4.25	01001	4.25	01010	-4.2	01010	4.2	01011	-4.15	01011	4.15	01100	-4.1	01100	4.1	01101	-4.05	01101	4.05	01110	-4	01110	4	01111	-3.95	01111	3.95	10000	-3.9	10000	3.9	10001	-3.85	10001	3.85	10010	-3.8	10010	3.8	10011	-3.75	10011	3.75	10100	-3.7	10100	3.7	10101	-3.65	10101	3.65	10110	-3.6	10110	3.6	10111	-3.55	10111	3.55	11000	-3.5	11000	3.5	11001	-3.45	11001	3.45	11010	-3.4	11010	3.4	11011	-3.35	11011	3.35	11100	-3.3	11100	3.3
VRHN[4:0]	GVCL	VRHP[4:0]	GVDD																																																																																																																																						
00000	-4.7	00000	4.7																																																																																																																																						
00001	-4.65	00001	4.65																																																																																																																																						
00010	-4.6	00010	4.6																																																																																																																																						
00011	-4.55	00011	4.55																																																																																																																																						
00100	-4.5	00100	4.5																																																																																																																																						
00101	-4.45	00101	4.45																																																																																																																																						
00110	-4.4	00110	4.4																																																																																																																																						
00111	-4.35	00111	4.35																																																																																																																																						
01000	-4.3	01000	4.3																																																																																																																																						
01001	-4.25	01001	4.25																																																																																																																																						
01010	-4.2	01010	4.2																																																																																																																																						
01011	-4.15	01011	4.15																																																																																																																																						
01100	-4.1	01100	4.1																																																																																																																																						
01101	-4.05	01101	4.05																																																																																																																																						
01110	-4	01110	4																																																																																																																																						
01111	-3.95	01111	3.95																																																																																																																																						
10000	-3.9	10000	3.9																																																																																																																																						
10001	-3.85	10001	3.85																																																																																																																																						
10010	-3.8	10010	3.8																																																																																																																																						
10011	-3.75	10011	3.75																																																																																																																																						
10100	-3.7	10100	3.7																																																																																																																																						
10101	-3.65	10101	3.65																																																																																																																																						
10110	-3.6	10110	3.6																																																																																																																																						
10111	-3.55	10111	3.55																																																																																																																																						
11000	-3.5	11000	3.5																																																																																																																																						
11001	-3.45	11001	3.45																																																																																																																																						
11010	-3.4	11010	3.4																																																																																																																																						
11011	-3.35	11011	3.35																																																																																																																																						
11100	-3.3	11100	3.3																																																																																																																																						

11101	-3.25	11101	3.25
11110	-3.2	11110	3.2
11111	-3.15	11111	3.15

9.2.27 Power Control 4 (RB2h)

Power Control 4 (RB2h)																																				
RS	WRX	RDX	D15	D14	D13	D12	D11	D10	D9	D8	D7	D6	D5	D4	D3	D2	D1	D0																		
1	↑	1	0	0	0	0	0	AVCLS2	AVCLS1	AVCLS0	0	0	BCLK _DIV1	BCLK _DIV0	0	AVDDS2	AVDDS1	AVDDS0																		
<b>Default value</b>			0	0	0	0	0	0	1	1	0	0	0	1	0	0	1	1																		
<b>Description</b>	<p><b>AVCLS [2:0]:</b> VCL voltage setting</p> <table border="1"> <thead> <tr> <th>AVCLS[2:0]</th> <th>VCL</th> </tr> </thead> <tbody> <tr> <td>000</td> <td>-4.5</td> </tr> <tr> <td>001</td> <td>-4.6</td> </tr> <tr> <td>010</td> <td>-4.7</td> </tr> <tr> <td>011</td> <td>-4.8</td> </tr> <tr> <td>100</td> <td>-4.9</td> </tr> <tr> <td>101</td> <td>-5</td> </tr> <tr> <td>110</td> <td>-5.1</td> </tr> <tr> <td>111</td> <td>Don't use this setting, reserve for testing.</td> </tr> </tbody> </table>																		AVCLS[2:0]	VCL	000	-4.5	001	-4.6	010	-4.7	011	-4.8	100	-4.9	101	-5	110	-5.1	111	Don't use this setting, reserve for testing.
	AVCLS[2:0]	VCL																																		
	000	-4.5																																		
	001	-4.6																																		
010	-4.7																																			
011	-4.8																																			
100	-4.9																																			
101	-5																																			
110	-5.1																																			
111	Don't use this setting, reserve for testing.																																			
<p><b>BCLK_DIV [1:0]:</b> Boost pumping frequency.</p> <table border="1"> <thead> <tr> <th>BCLK_DIV[1:0]</th> <th>Frequency (KHz)</th> </tr> </thead> <tbody> <tr> <td>00</td> <td>4000</td> </tr> <tr> <td>01</td> <td>2000</td> </tr> <tr> <td>10</td> <td>1333</td> </tr> <tr> <td>11</td> <td>1000</td> </tr> </tbody> </table>																		BCLK_DIV[1:0]	Frequency (KHz)	00	4000	01	2000	10	1333	11	1000									
BCLK_DIV[1:0]	Frequency (KHz)																																			
00	4000																																			
01	2000																																			
10	1333																																			
11	1000																																			
<p><b>AVDDS [2:0]:</b> AVDD voltage setting</p> <table border="1"> <thead> <tr> <th>AVDDS[2:0]</th> <th>AVDD</th> </tr> </thead> <tbody> <tr> <td>000</td> <td>4.5</td> </tr> <tr> <td>001</td> <td>4.6</td> </tr> <tr> <td>010</td> <td>4.7</td> </tr> <tr> <td>011</td> <td>4.8</td> </tr> </tbody> </table>																		AVDDS[2:0]	AVDD	000	4.5	001	4.6	010	4.7	011	4.8									
AVDDS[2:0]	AVDD																																			
000	4.5																																			
001	4.6																																			
010	4.7																																			
011	4.8																																			



		100	4.9
		101	5
		110	5.1
		111	Don't use this setting, reserve for testing.

9.2.28 NVM ID Code (RD2h)

NVM ID Code (RD2h)																		
RS	WRX	RDX	D15	D14	D13	D12	D11	D10	D9	D8	D7	D6	D5	D4	D3	D2	D1	D0
1	↑	1	0	0	0	0	0	0	0	0	0	0	0	0	ID3	ID2	ID1	ID0
Default value			0	0	0	0	0	0	0	0	0	0	0	0	0	0	0	0
Description			ID [3:0]: ST7775R supply 4bit ID code for LCD module version ID															

9.2.29 NVM Control Status (RD9h)

NVM Control Status (RD9h)																		
RS	WRX	RDX	D15	D14	D13	D12	D11	D10	D9	D8	D7	D6	D5	D4	D3	D2	D1	D0
1	↑	1	0	0	0	0	0	0	0	0	0	VMF_EN	0	0	0	0	0	0
Default value			0	0	0	0	0	0	0	0	0	0	0	0	0	0	0	0
Description			<b>VMF_EN:</b> "1" = Command NVM VCOM Offset Control (RFEh) Enable. "0" = Command NVM VCOM Offset Control (RFEh) Disable.															

Preliminary

9.2.30 NVM Write Command (RDFh)

NVM Write Command (RDFh)																		
RS	WRX	RDX	D15	D14	D13	D12	D11	D10	D9	D8	D7	D6	D5	D4	D3	D2	D1	D0
1	↑	1	0	0	0	0	0	0	0	0	1	0	1	0	0	1	0	1
Description			<p>NVM Write Command.</p> <p style="text-align: center;">NVM Program Flow</p> <pre> graph TD     A[/Modify CMD register (D2h) CMD D2h, xxh/] --&gt; B[/Modify CMD register (FEh) CMD D9h, 40h CMD FEh, xxh CMD D9h, 00h/]     B --&gt; C[/Enable NVM : CMD FFh, 01h CMD FAh, 86h External VPP = 7.5V ON/]     C --&gt; D[/Erase CMD: CMD DFh, C5h CMD DFh, A5h/]     D --&gt; E[/Program CMD: CMD DFh, 3Ah CMD DFh, A5h/]     E --&gt; F[/Wait 20ms/]     F --&gt; G[/Disable NVM : CMD FAh, 04h CMD FFh, 00h External VPP = 7.5V OFF/]     G --&gt; H[/Wait 20ms/]     </pre> <p><b>Legend</b></p> <ul style="list-style-type: none"> <li>Command (Parallelogram)</li> <li>Parameter (Trapezoid)</li> <li>Display (Oval)</li> <li>Action (Hexagon)</li> <li>Mode (Rounded rectangle)</li> <li>Sequential transfer (Wavy-bottom rectangle)</li> </ul>															

9.2.31 NVM Enable (RFAh)

NVM Enable (RFAh)																		
RS	WRX	RDX	D15	D14	D13	D12	D11	D10	D9	D8	D7	D6	D5	D4	D3	D2	D1	D0
1	↑	1	0	0	0	0	0	0	0	0	PROG_MODE	0	0	0	0	1	NVM_PROG	0
Default value			0	0	0	0	0	0	0	0	0	0	0	0	0	1	0	0
Description			<p>PROG_MODE: "1" = Enable NVM digital Function.</p> <p>NVM_PROG: "1" =Enable NVM Function.</p>															

9.2.32 NVM VCOM Offset (RFEh)

NVM VCOM Offset (RFEh)																																										
RS	WRX	RDX	D15	D14	D13	D12	D11	D10	D9	D8	D7	D6	D5	D4	D3	D2	D1	D0																								
1	↑	1	0	0	0	0	0	0	0	0	1	0	0	VMF4	VMF3	VMF2	VMF1	VMF0																								
Default value			0	0	0	0	0	0	0	0	1	0	0	1	0	0	0	0																								
Description			<p>VCMF[4:0]: Set VCOM voltage level for reduce the flicker issue. ("1d"=25mV)</p> <table border="1"> <thead> <tr> <th>VCMF[4:0]</th> <th>VCOM Output Level</th> </tr> </thead> <tbody> <tr> <td>00000</td> <td>"VCOM"-16d</td> </tr> <tr> <td>00001</td> <td>"VCOM"-15d</td> </tr> <tr> <td> </td> <td> </td> </tr> <tr> <td>01110</td> <td>"VCOM"-2d</td> </tr> <tr> <td>01111</td> <td>"VCOM"-1d</td> </tr> <tr> <td>10000</td> <td>"VCOM"</td> </tr> <tr> <td>10001</td> <td>"VCOM"+1d</td> </tr> <tr> <td>10010</td> <td>"VCOM"+2d</td> </tr> <tr> <td> </td> <td> </td> </tr> <tr> <td>11110</td> <td>"VCOM"+14d</td> </tr> <tr> <td>11111</td> <td>"VCOM"+15d</td> </tr> </tbody> </table>																VCMF[4:0]	VCOM Output Level	00000	"VCOM"-16d	00001	"VCOM"-15d			01110	"VCOM"-2d	01111	"VCOM"-1d	10000	"VCOM"	10001	"VCOM"+1d	10010	"VCOM"+2d			11110	"VCOM"+14d	11111	"VCOM"+15d
VCMF[4:0]	VCOM Output Level																																									
00000	"VCOM"-16d																																									
00001	"VCOM"-15d																																									
01110	"VCOM"-2d																																									
01111	"VCOM"-1d																																									
10000	"VCOM"																																									
10001	"VCOM"+1d																																									
10010	"VCOM"+2d																																									
11110	"VCOM"+14d																																									
11111	"VCOM"+15d																																									

9.2.33 NVM Command Enable (RFFh)

NVM Command Enable (RFFh)																		
RS	WRX	RDX	D15	D14	D13	D12	D11	D10	D9	D8	D7	D6	D5	D4	D3	D2	D1	D0
1	↑	1	0	0	0	0	0	0	0	0	0	0	0	0	0	0	CMD1_EN	CMD2_EN
Description			<p>CMD2_EN:"1" for enable DFh function.</p>															

10 RESET FUNCTION

The ST7775R is initialized by the RESET input. During reset period, the ST7775R is in a busy state and instruction from the MCU and DRAM access are not accepted. The ST7775R's internal power supply circuit unit is initialized also by the RESET input. The RESET period must be secured for at least 1ms. In case of power-on reset, wait until the RC oscillation frequency stabilizes (for 1 ms). During this period, DRAM access and initial instruction setting are prohibited.

10.1.. System Function Command List

See the Instruction description. The default value is shown in the parenthesis of each instruction bit cell.

10.2.. RAM Data Initialization

The RAM data is not automatically initialized by the RESET input. It must be initialized by software in display-off period.

10.3.. Note on Reset Function

- When a RESET input is entered into the ST7775R while it is in deep standby mode, the ST7775R starts up the inside logic regulator and makes a transition to the initial state. During this period, the state of the interface pins may become unstable. For this reason, do not enter a RESET input in deep standby mode.
- When transferring instruction in either two or three transfers via 8-/9-/16-bit interface, make sure to execute data transfer synchronization after reset operation.

10.4.. Reset Timing Characteristic

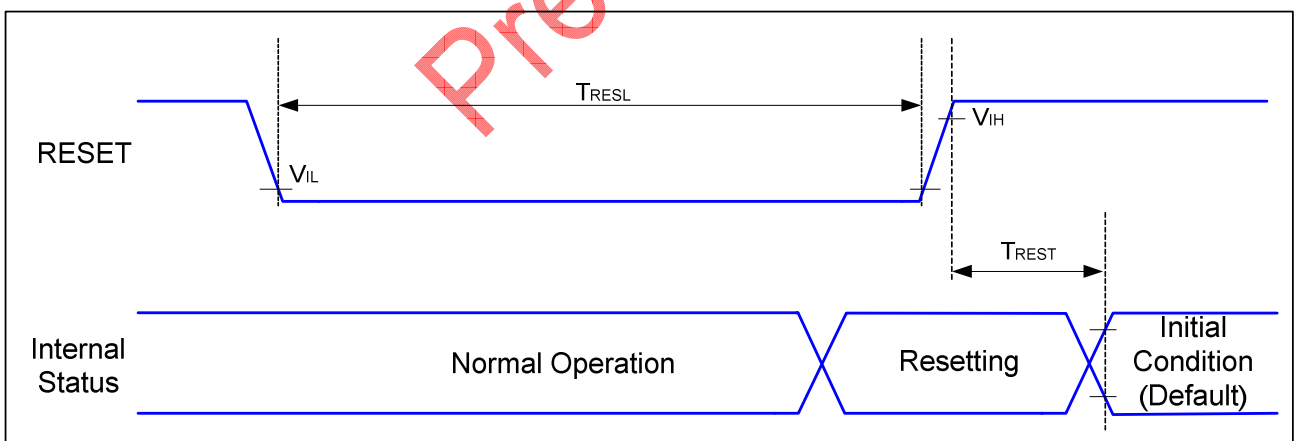

Figure 51 Reset Timing

Signal	Symbol	Parameter	Min	Max	Unit	Description
RESET	TRESL	Reset Low Level Width	1	-	ms	-
	TREST	Reset Complete Time	1		ms	

Table 11 Reset timing Characteristics

Preliminary

11 8 - COLOR DISPLAY MODE

The ST7775R has a function to display in 8 colors. In this display mode, only V0 and V63 are used and power supplies to other grayscales are turned off to reduce power consumption. In 8-color display mode, the  $\gamma$ -adjustment registers KP0~5, SELV0~1P, SELV62~63P, KN0~5, SELV0~1N, SELV62~63N, are disabled and the power supplies to V1 to V62 are halted. The ST7775R does not require DRAM data rewrite for 8-color display by writing the MSB to the rest in each dot data to display in 8 colors.

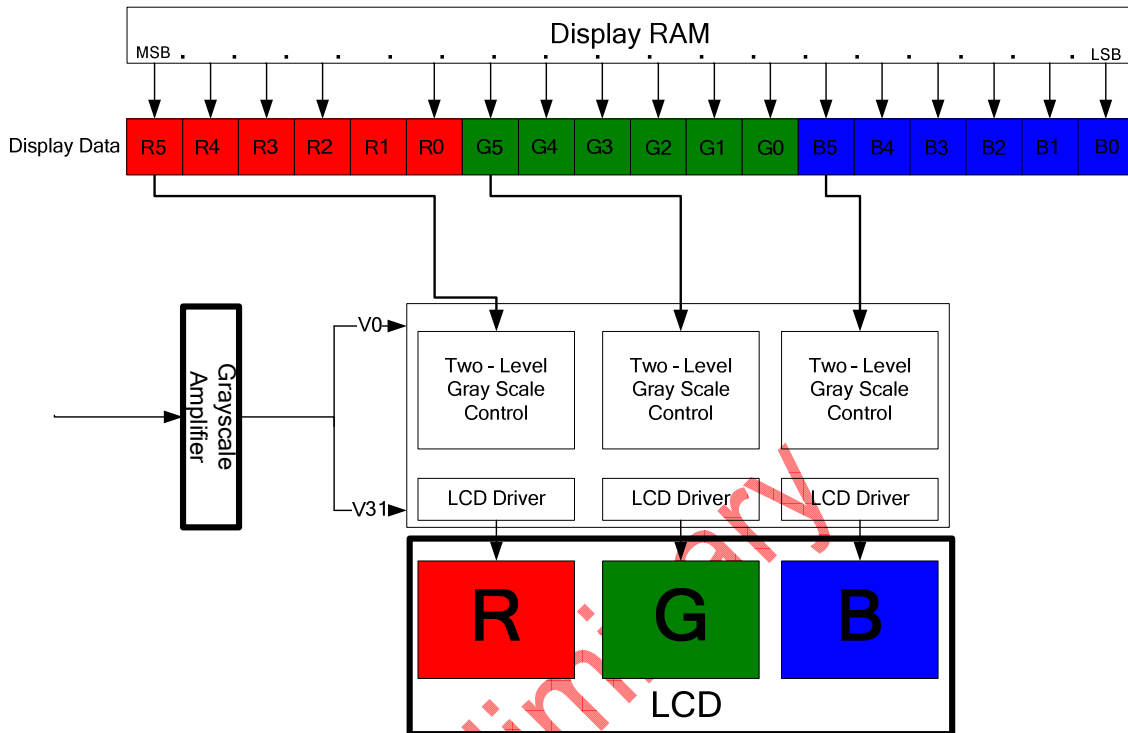

Figure 52 8-Color Display Mode

## 12 WINDOW ADDRESS FUNCTION

The window address function enables writing display data consecutively in a rectangular area (a window address area) made on the internal DRAM. The window address area is made by setting the horizontal address register (star: HAS[7:0], end HEA[7:0] bits) and the vertical address register(start: VSA[7:0], end: VEA[7:0] bits) The AM bits sets the transition direction of RAM address(either increment or decrement). These bits enable the ST7775R to write data including image data consecutively not taking data wrap positions into account.

The window address area must be made within the DRAM address map area. Also, DRAM address bits (RAM address set register) must be an address within the window address area.

[Window address setting area]

(Horizontal direction)  $00H \leq HSA[7:0] \leq HEA[7:0] \leq "AF"H$

(Vertical direction)  $00H \leq VSA[7:0] \leq VEA[7:0] \leq "BD"H$

[RAM address, AD (an address within a window address area)]

(RAM address)  $HSA[7:0] \leq AD[7:0] \leq HEA[7:0]$

$VSA[7:0] \leq AD[15:8] \leq VEA[7:0]$

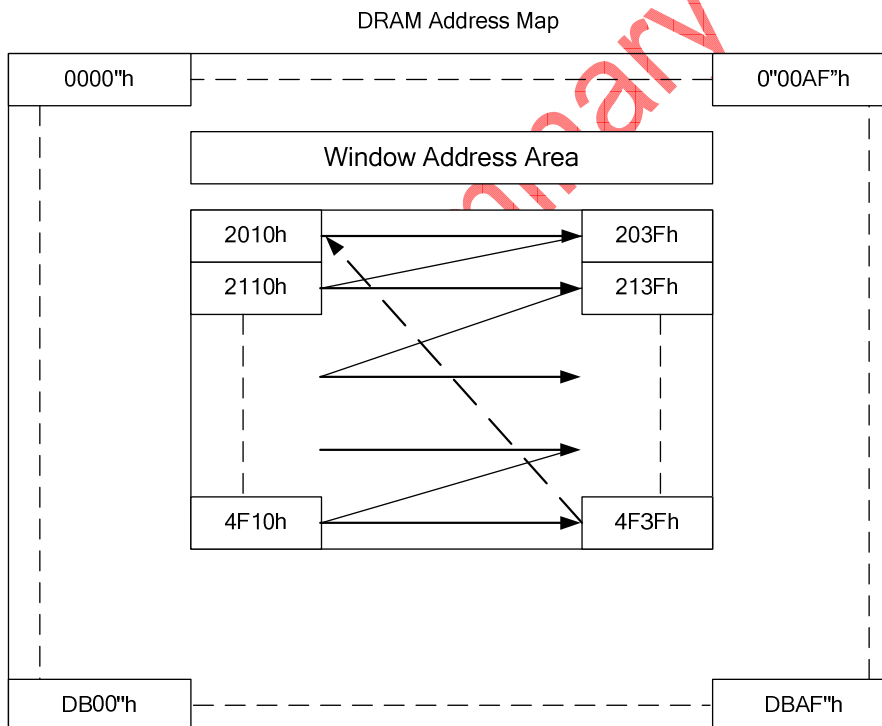

Window address setting area

HSA[7:0] = 10h, HSA[7:0] = 3Fh, I/D = 1 (increment)  
 VSA[7:0] = 20h, VSA[7:0] = 4Fh, AM = 0 (horizontal writing)

Figure 53 DRAM Access Window Map

13 GAMMA CORRECTION

The structure of grayscale amplifier is shown as below. 16 voltage levels between GVDD and VSS are determined by the high/ mid/ low level adjustment registers. Each mid-adjustment level is split into 64 levels again by the internal ladder resistor network. As a result, grayscale amplifier generates 64 voltage levels ranging from V0 to V63 and outputs one of 64 levels.

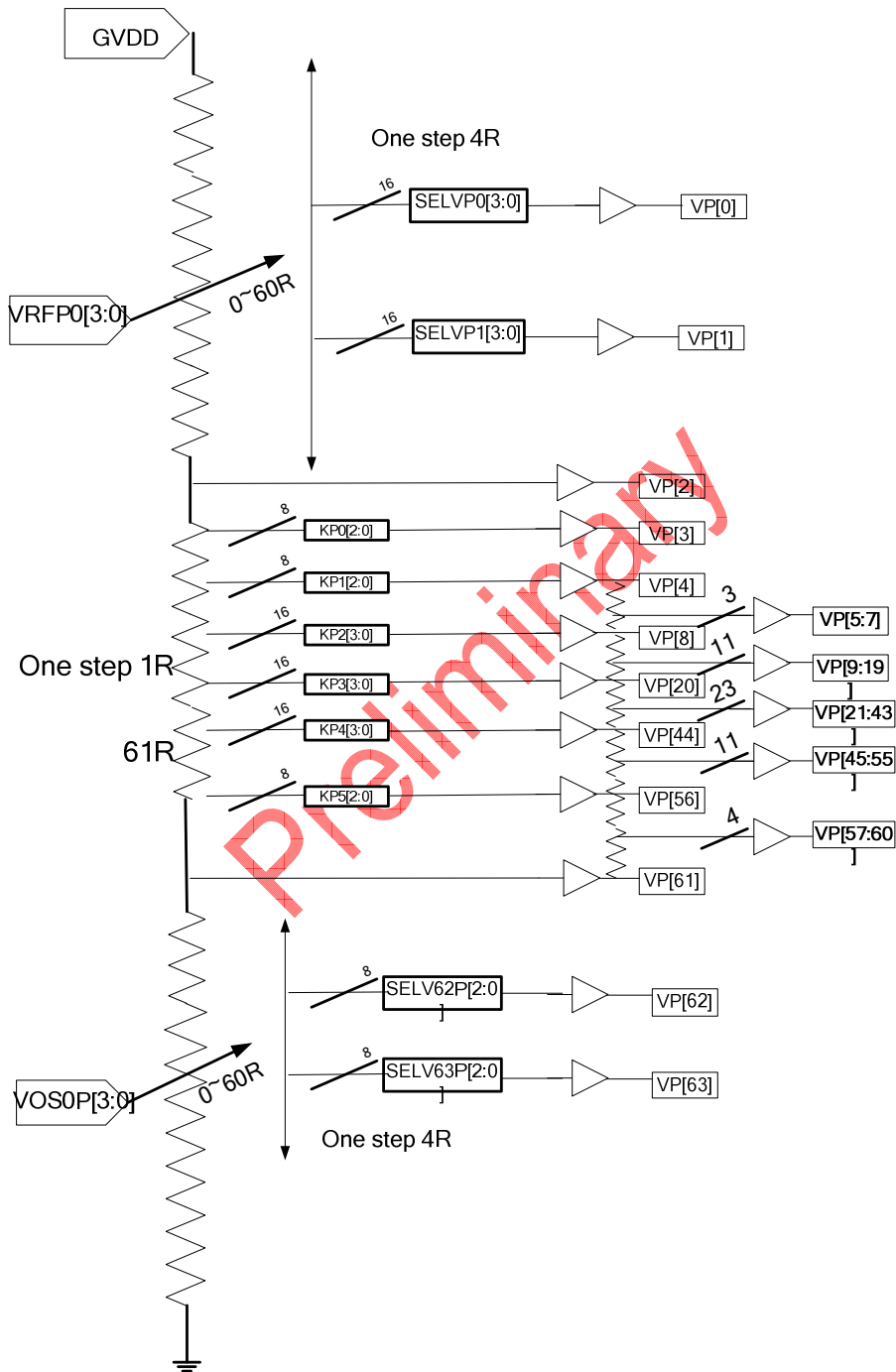

Figure 54 Grayscale Voltage Generation (Positive)



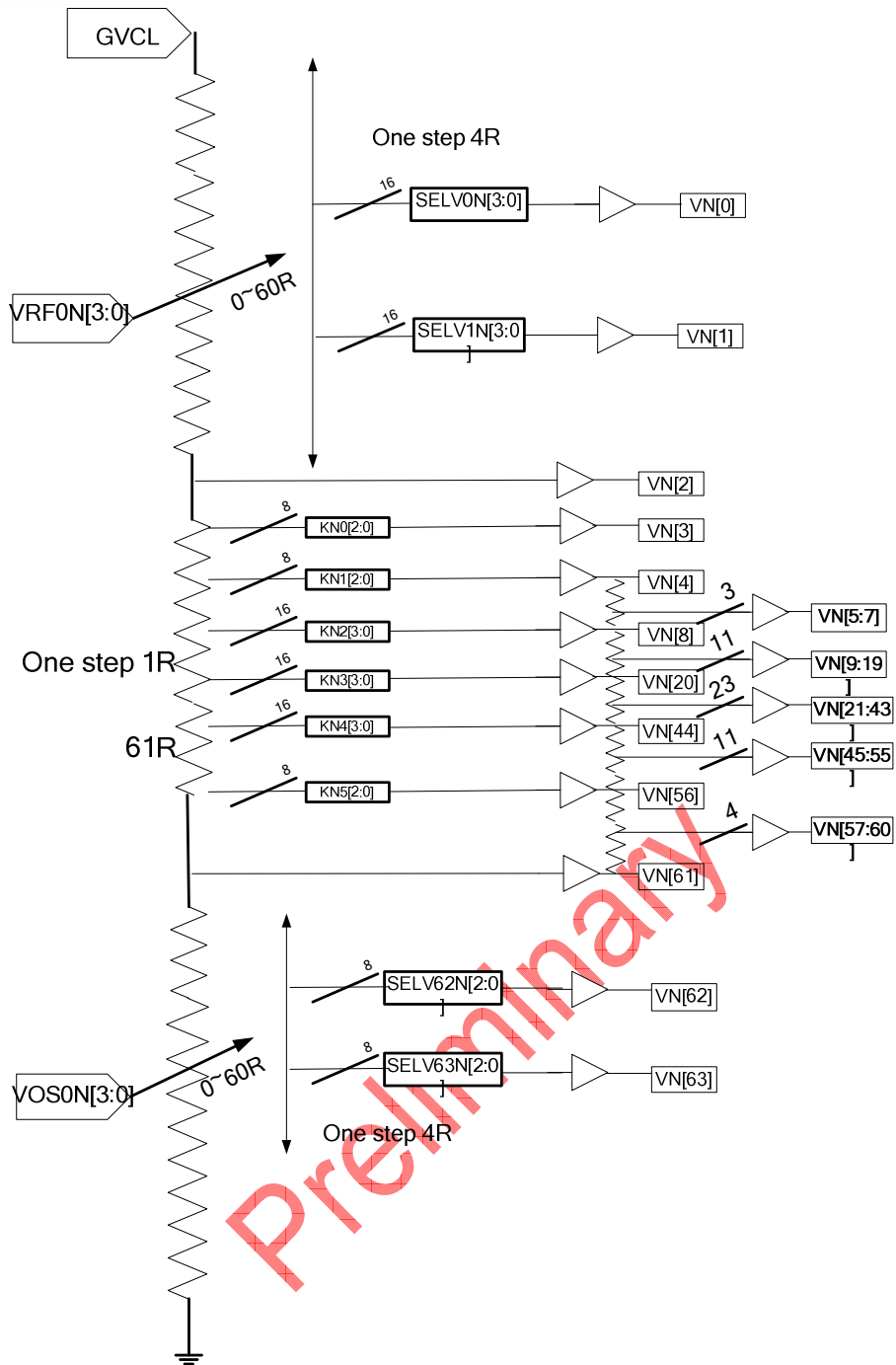

Figure 55 Grayscale Voltage Generation (Negative)

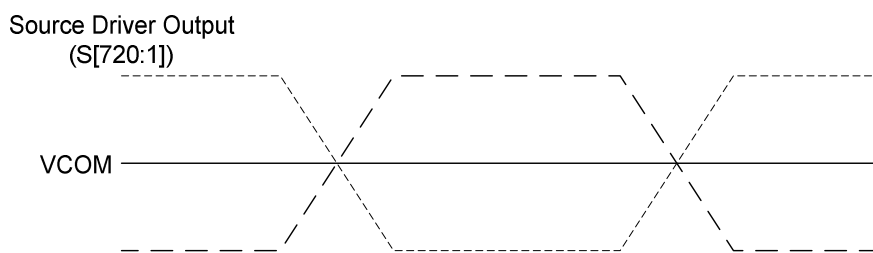

Figure 56 Relationship between Source Output and VCOM

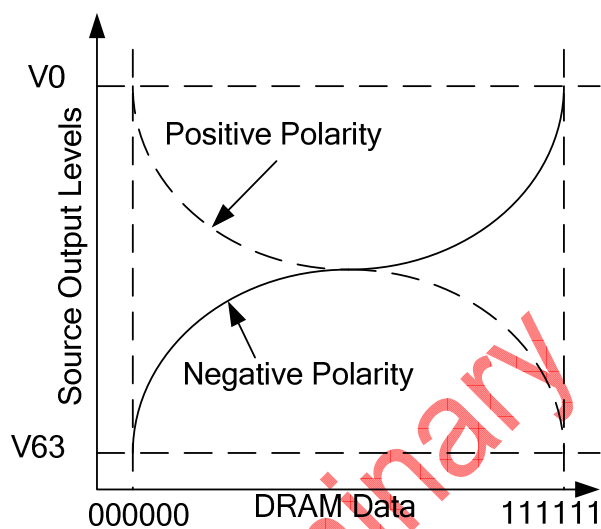

Figure 57 Relationship between DRAM Data and Output Level

Preliminary

14 APPLICATION

14.1.. Configuration of Power Supply Circuit

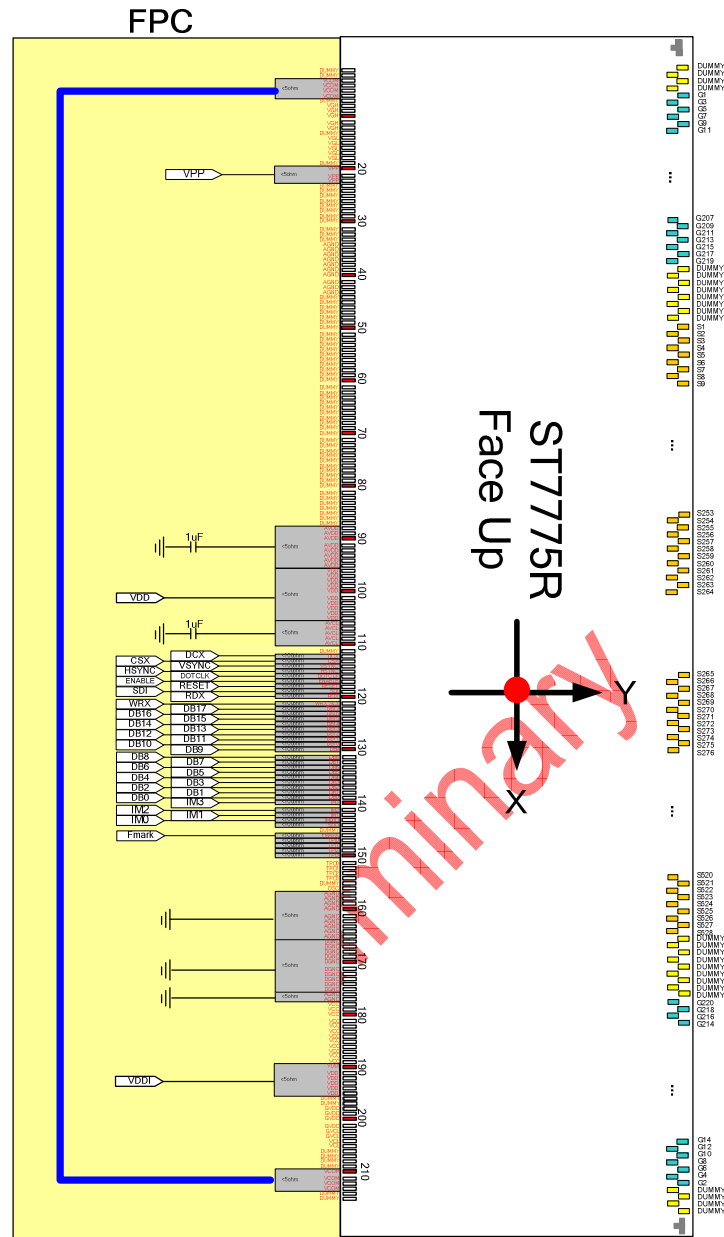

Figure 58 Power Supply Circuit Block

The following table shows specifications of external elements connected to the ST7775R power supply circuit.

Items	Recommended Specification	Pin Connection
1 µF Capacity	6.3 V	AVCL, AVDD

Table 12 Outside Components

14.2.. Standby Mode

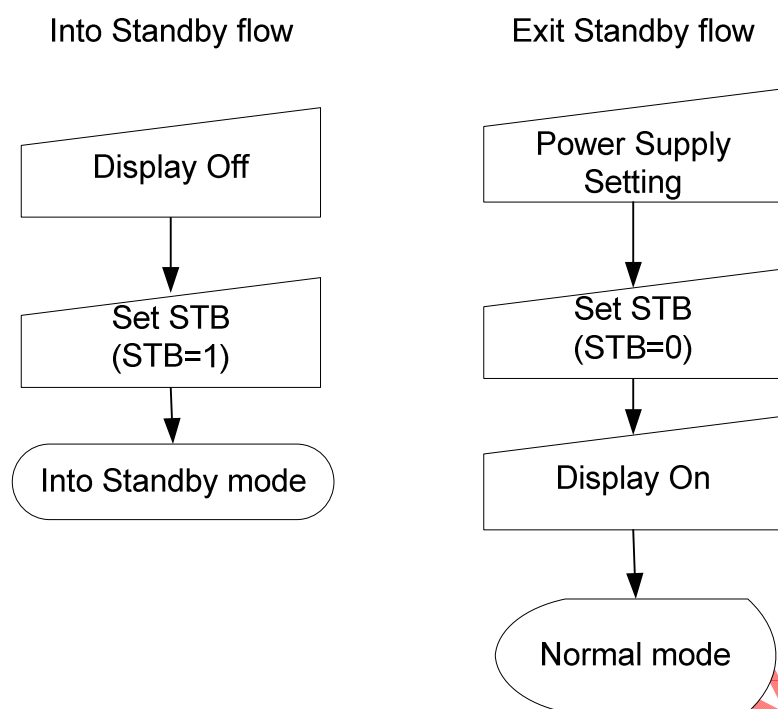

Figure 59 Standby Mode Register Setting Sequence

Preliminary

14.3.. Power Supply Configuration

When supplying and cutting off power, follow the sequence below. The setting time for oscillators, circuits and operational amplifiers depends on external resistance and capacitance.

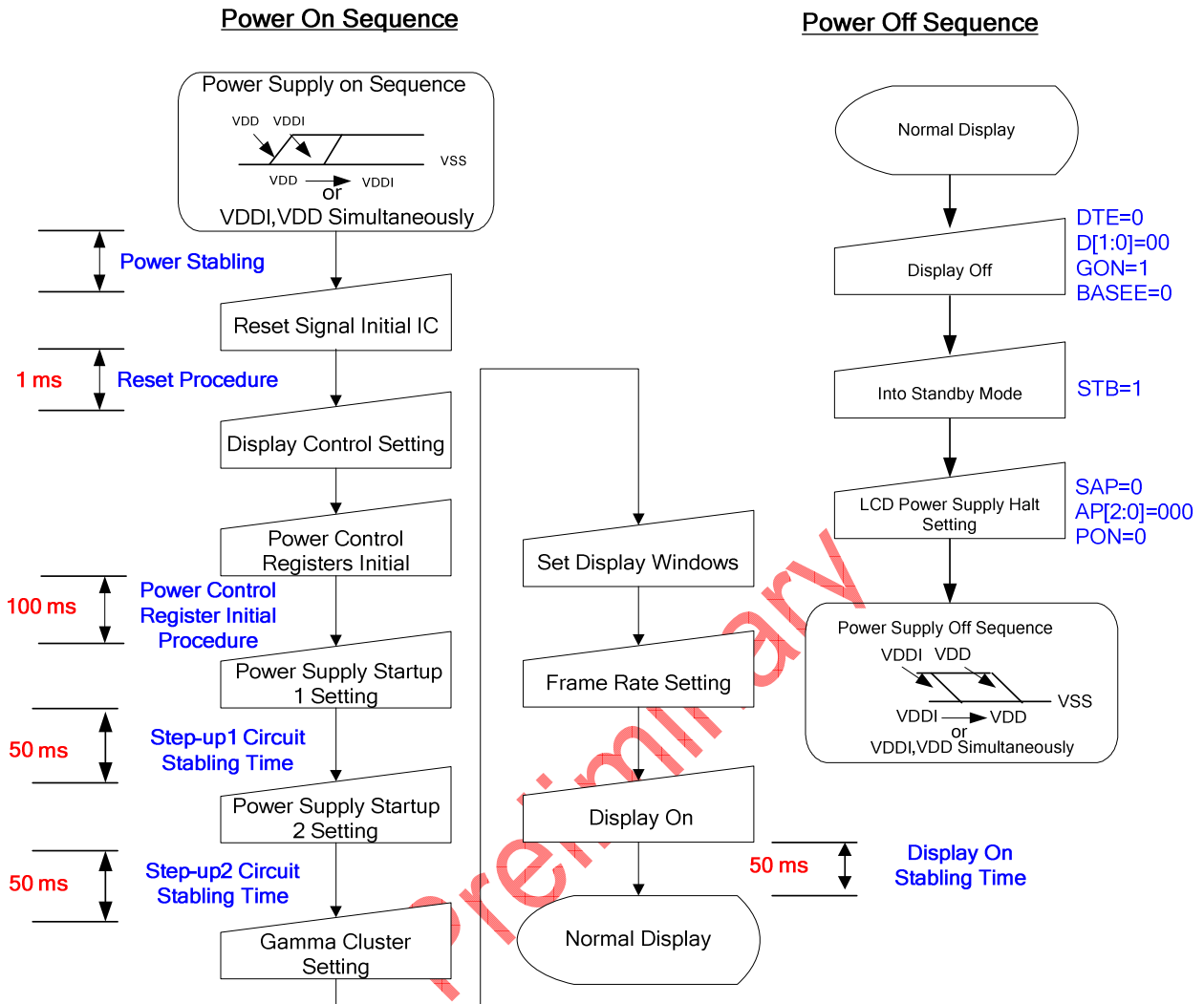

Figure 60 Power Supply ON/OFF Sequence

14.4.. Voltage Generation

The pattern diagram for setting the voltages and the waveforms of the voltages of the ST7775R are as follows.

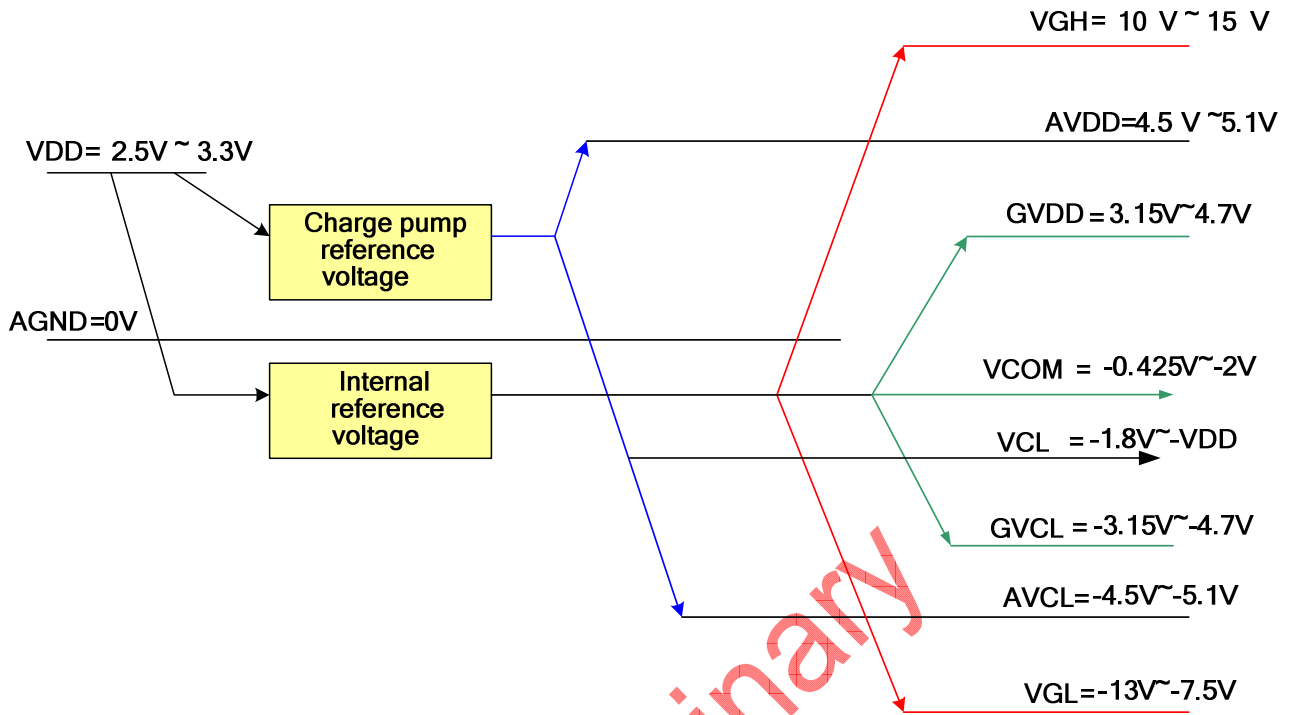

Figure 61 Power Booster Level

14.5.. Applied Voltage to the TFT panel

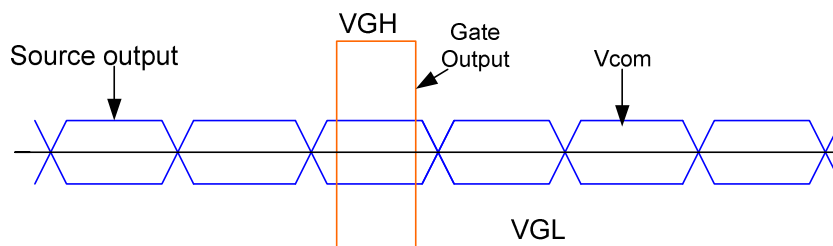

Figure 62 Voltage Output to TFT LCD Panel

Preliminary

**15 REVISION HISTORY**

Version	Date	Description
0.1	2010/03	First issue

Preliminary