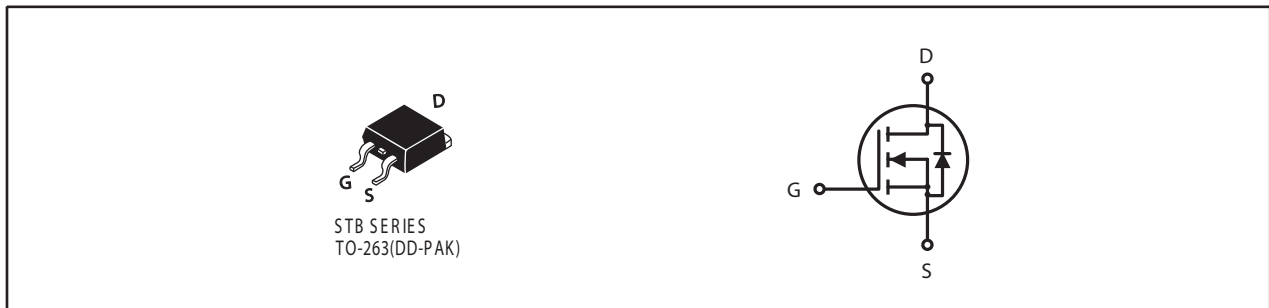

**N-Channel Logic Level Enhancement Mode Field Effect Transistor****PRODUCT SUMMARY**

V <sub>DSS</sub>	I <sub>D</sub>	R <sub>DS(ON)</sub> (mΩ) Max
100V	120A	4.0 @ V <sub>GS</sub> =10V

**FEATURES**

- Super high dense cell design for extremely low R<sub>DS(ON)</sub>.
- High power and current handling capability.
- TO-263 package.

**ABSOLUTE MAXIMUM RATINGS (T<sub>C</sub>=25°C unless otherwise noted)**

Symbol	Parameter	Limit	Units
V <sub>DS</sub>	Drain-Source Voltage	100	V
V <sub>GS</sub>	Gate-Source Voltage	±20	V
I <sub>D</sub>	Drain Current-Continuous <sup>b</sup>	T <sub>C</sub> =25°C	120
		T <sub>C</sub> =100°C	76
I <sub>DM</sub>	-Pulsed <sup>b</sup>	480	A
E <sub>AS</sub>	Single Pulse Avalanche Energy <sup>c</sup>	300	mJ
P <sub>D</sub>	Maximum Power Dissipation	T <sub>C</sub> =25°C	227
		T <sub>C</sub> =100°C	91
T <sub>J</sub> , T <sub>STG</sub>	Operating Junction and Storage Temperature Range	-55 to 150	°C

**THERMAL CHARACTERISTICS**

R <sub>θJC</sub>	Thermal Resistance, Junction-to-Case	0.55	°C/W
R <sub>θJA</sub>	Thermal Resistance, Junction-to-Ambient	62.5	°C/W

# STB10N03

Ver 1.0

## ELECTRICAL CHARACTERISTICS (T<sub>C</sub>=25°C unless otherwise noted)

Symbol	Parameter	Conditions	Min	Typ	Max	Units
<b>OFF CHARACTERISTICS</b>						
BV <sub>DSS</sub>	Drain-Source Breakdown Voltage	V <sub>GS</sub> =0V , I <sub>D</sub> =250uA	100			V
I <sub>DSS</sub>	Zero Gate Voltage Drain Current	V <sub>DS</sub> =80V , V <sub>GS</sub> =0V			1	uA
I <sub>GSS</sub>	Gate-Body leakage current	V <sub>GS</sub> = ±20V , V <sub>DS</sub> =0V			±100	nA
<b>ON CHARACTERISTICS</b>						
V <sub>GS(th)</sub>	Gate Threshold Voltage	V <sub>DS</sub> =V <sub>GS</sub> , I <sub>D</sub> =250uA	2	3	4	V
R <sub>DS(ON)</sub>	Drain-Source On-State Resistance	V <sub>GS</sub> =10V , I <sub>D</sub> =50A		3.3	4.0	m ohm
g <sub>FS</sub>	Forward Transconductance	V <sub>DS</sub> =10V , I <sub>D</sub> =20A		47		S
<b>DYNAMIC CHARACTERISTICS <sup>a</sup></b>						
C <sub>ISS</sub>	Input Capacitance	V <sub>DS</sub> =50V, V <sub>GS</sub> =0V f=1.0MHz		6900		pF
C <sub>OSS</sub>	Output Capacitance			1250		pF
C <sub>RSS</sub>	Reverse Transfer Capacitance			47		pF
<b>SWITCHING CHARACTERISTICS <sup>a</sup></b>						
t <sub>D(ON)</sub>	Turn-On DelayTime	V <sub>DD</sub> =50V I <sub>D</sub> =1A		48		ns
t <sub>r</sub>	Rise Time			56		ns
t <sub>D(OFF)</sub>	Turn-Off DelayTime	V <sub>GS</sub> =10V R <sub>GEN</sub> = 2.5 ohm		75		ns
t <sub>f</sub>	Fall Time			33		ns
Q <sub>g</sub>	Total Gate Charge	V <sub>DS</sub> =50V, I <sub>D</sub> =20A, V <sub>GS</sub> =10V		117		nC
Q <sub>gs</sub>	Gate-Source Charge	V <sub>DS</sub> =50V, I <sub>D</sub> =20A, V <sub>GS</sub> =10V		40		nC
Q <sub>gd</sub>	Gate-Drain Charge			37		nC
<b>DRAIN-SOURCE DIODE CHARACTERISTICS</b>						
V <sub>SD</sub>	Diode Forward Voltage	V <sub>GS</sub> =0V, I <sub>S</sub> =50A		0.85	1.3	V
<b>Notes</b>						
<p>a. Guaranteed by design, not subject to production testing.                      b. Drain current limited by maximum junction temperature.                      c. Starting T<sub>J</sub>=25°C, L=0.5mH, V<sub>DD</sub> = 50V. (See Figure10)                      d. Mounted on FR4 Board of 1 inch<sup>2</sup> , 2oz.</p>						

Aug,31,2016

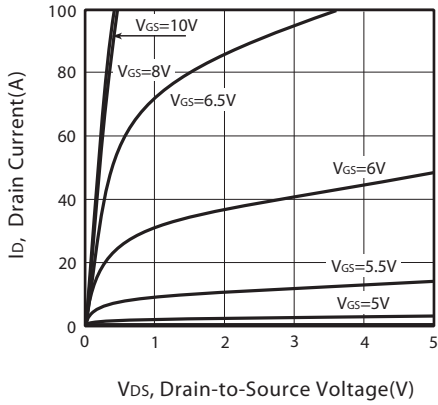

Figure 1. Output Characteristics

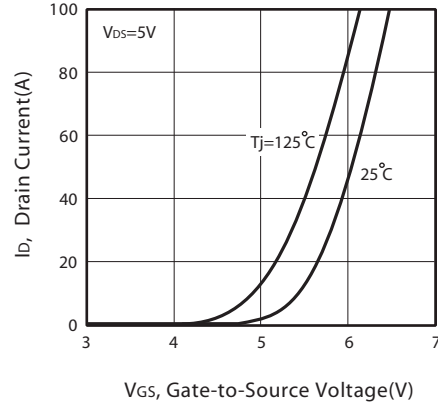

Figure 2. Transfer Characteristics

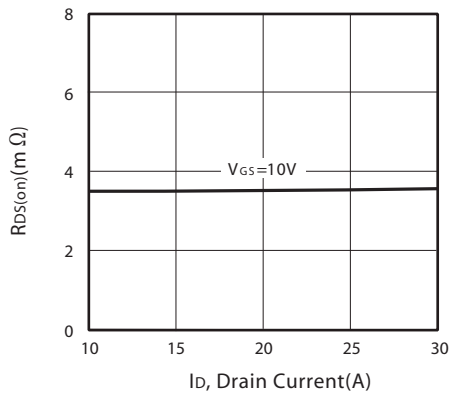

Figure 3. On-Resistance vs. Drain Current and Gate Voltage

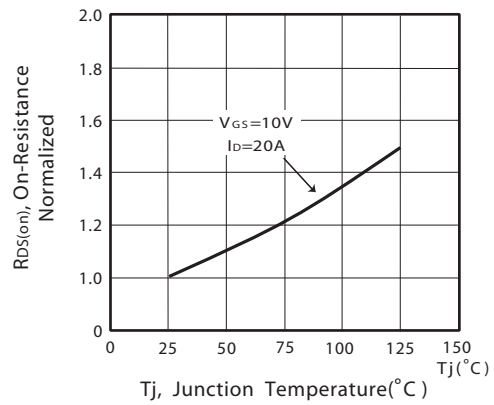

Figure 4. On-Resistance Variation with Drain Current and Temperature

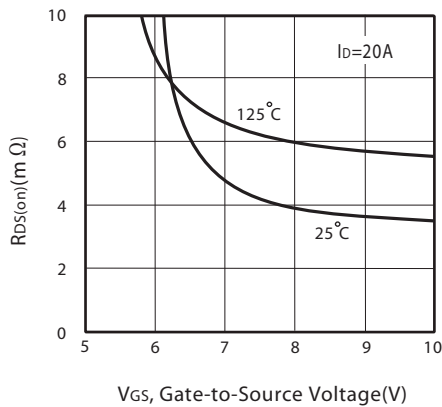

Figure 5. On-Resistance vs. Gate-Source Voltage

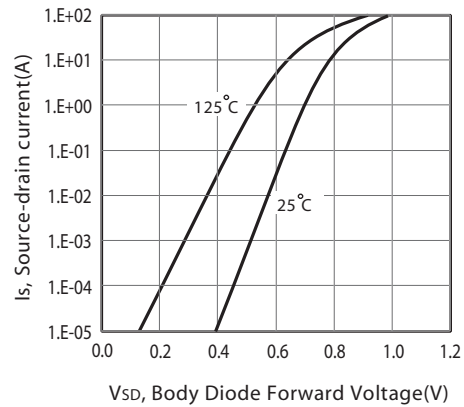
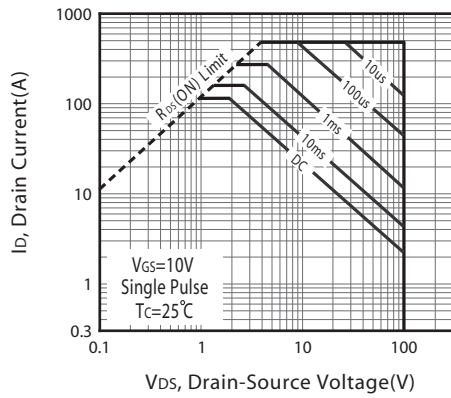
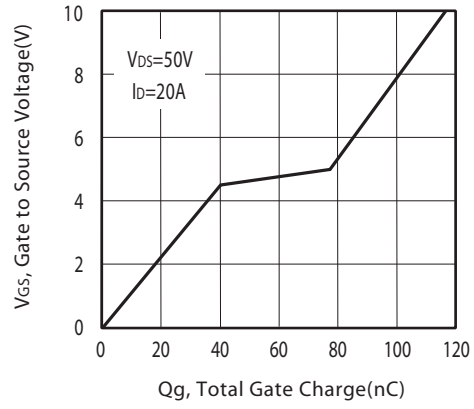
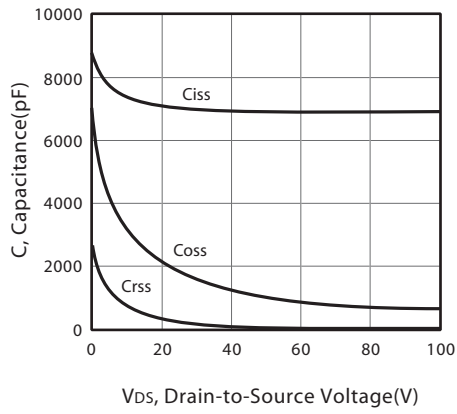
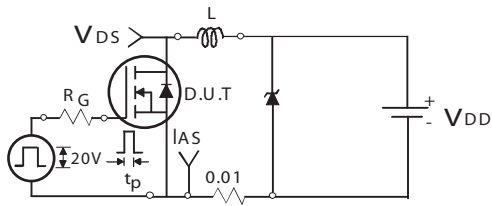

Figure 6. Body Diode Forward Voltage Variation with Source Current





Unclamped Inductive Test Circuit

Figure 10a.

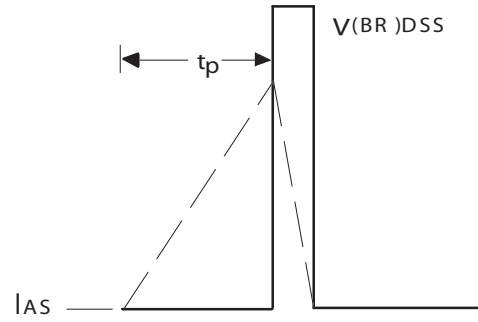

Unclamped Inductive Waveforms

Figure 10b.

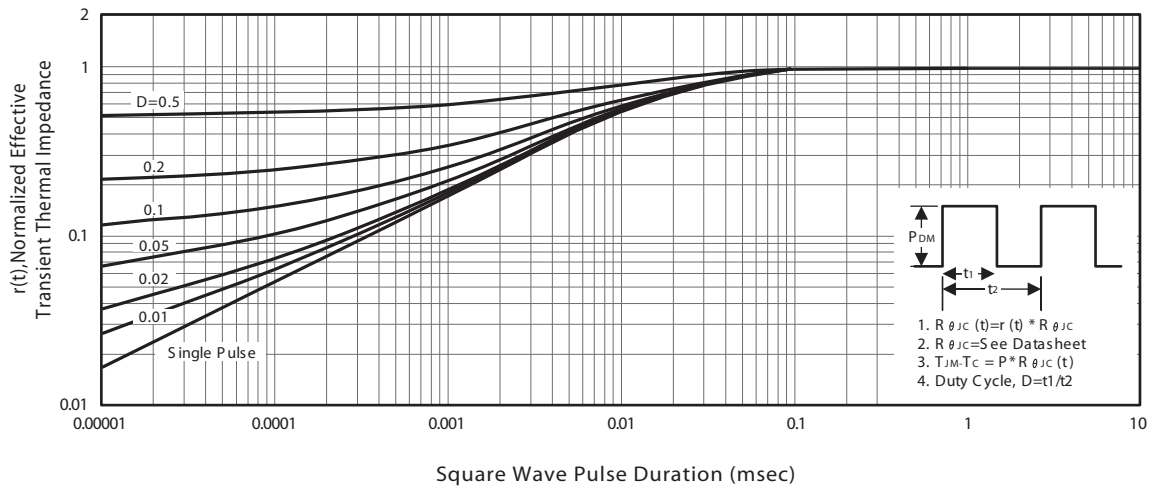
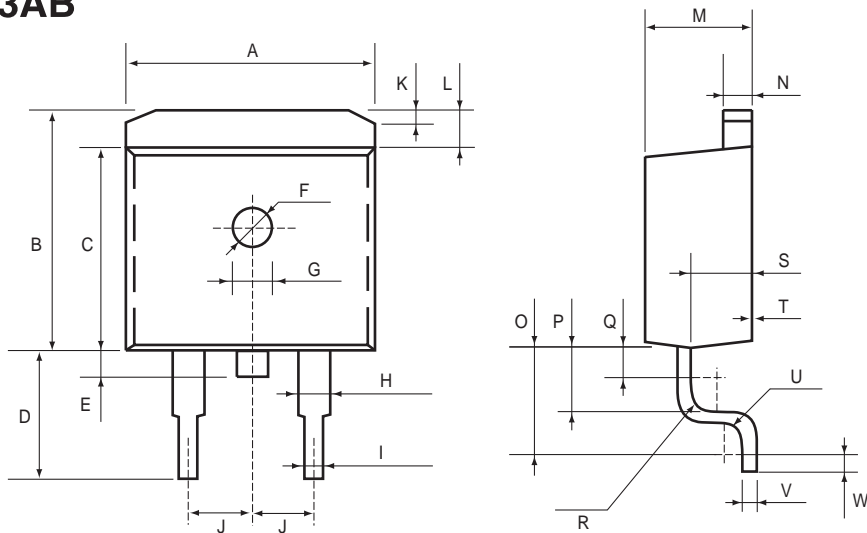

Figure 11. Normalized Thermal Transient Impedance Curve

## PACKAGE OUTLINE DIMENSIONS

### TO-263AB



SYMBOLS	MILLIMETERS		INCHES	
	MIN	MAX	MIN	MAX
A	9.9	10.5	0.390	0.413
B	9.5	10.3	0.374	0.406
C	8.3	8.9	0.327	0.350
D	4.7	5.5	0.185	0.217
E	1.5		0.059	
F	$\phi$ 1.6		$\phi$ 0.063	
G	1.0	1.4	0.039	0.055
H	1.07	1.47	0.042	0.058
I	0.76	1.06	0.030	0.042
J	2.04	3.04	0.080	0.120
K	0.2	0.6	0.0079	0.024
L	1.4		0.055	
M	4.24	4.64	0.167	0.183
N	1.15	1.45	0.045	0.057
O	3.25	3.75	0.128	0.148
P	2.3		0.091	
Q	1.6		0.063	
R	R0.4	R1.0	R0.0158	R0.0394
S	2.7 MAX		0.106 MAX	
T	0.0	0.3	0.0000	0.0118
U	R0.4	R1.0	R0.0158	R0.0394
V	0.3	0.5	0.0118	0.0197
W	1.2 min		0.047 min	

# STB10N03

Ver 1.0

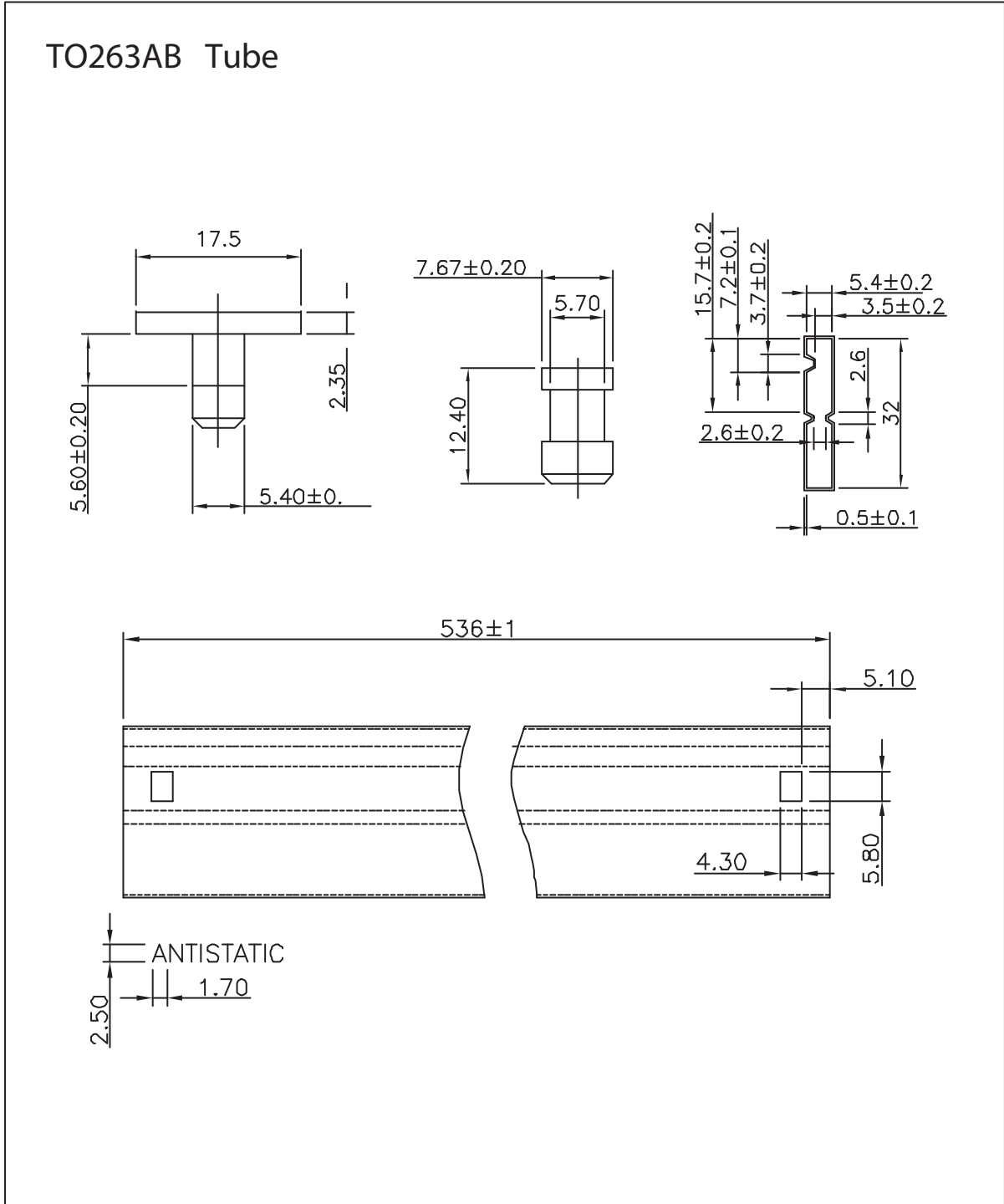

Aug,31,2016

# STB10N03

Ver 1.0

## TOP MARKING DEFINITION

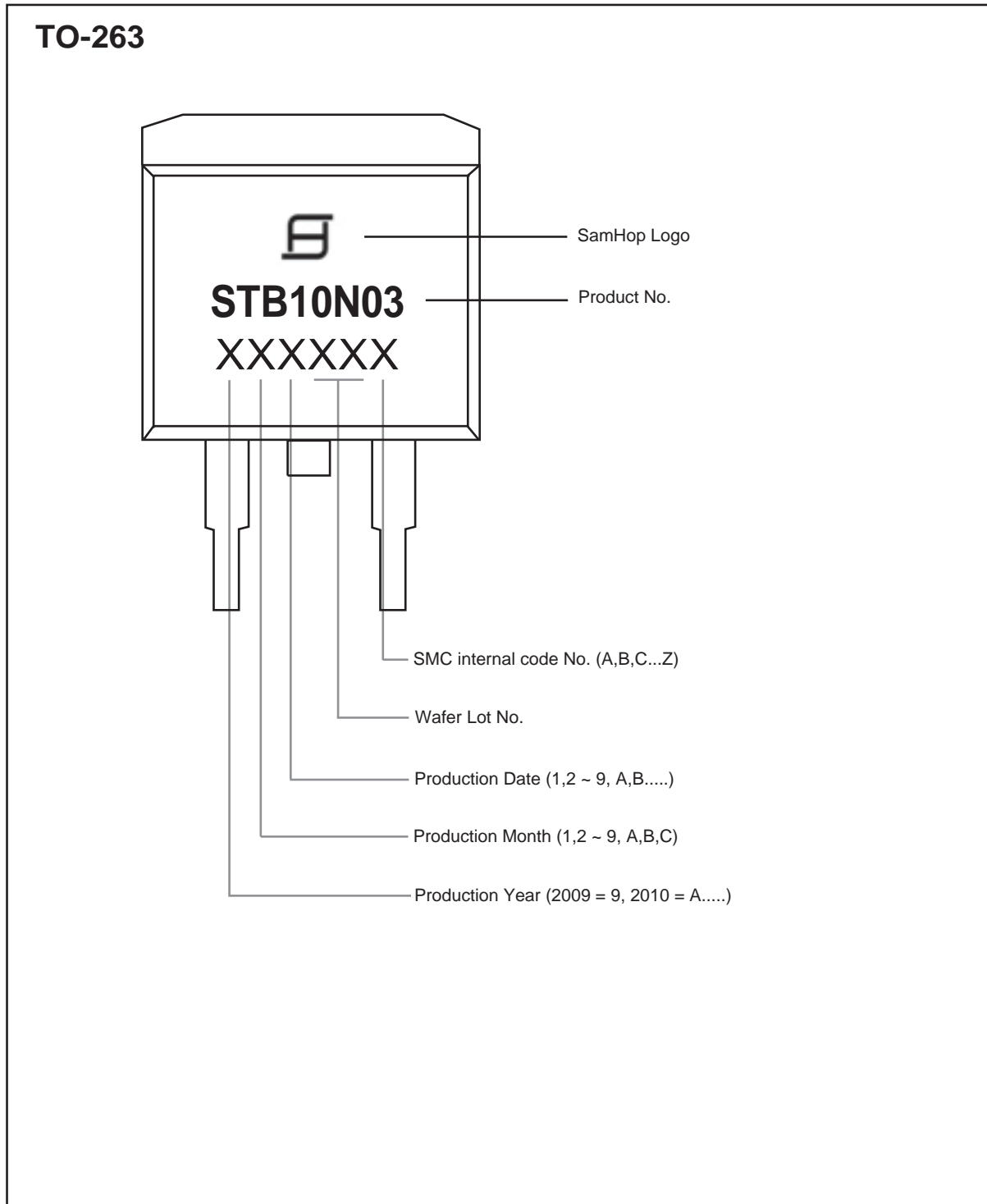

Aug,31,2016