

**Smart Temperature Compensation Attenuator DC~6GHz 50Ω 100mW 1~10dB N3~N9**
**Part No. Descriptions**

TCA Series	Frequency	Attenuation	Temperature Coefficient Code	Metallization Options	Termination Plating Options
TCA, STCA, MTCA, HTCA, or BTCA	(03, 06, 12 or 18)	(01 to 10) 1dB to 10 dB	(N3 to N10) or (P3 to P8)	Planar(no code), W1, W3, WB1 or G	(no code)=lead free or (S)=Lead(Pb)

Part No.	Frequency Range (GHz)	Attenuation (dB)	Temperature Coefficient Code	Temperature Coefficient of Attenuation (dB/dB/ )	Max. VSWR (:1) @1GHz@25	Max. Input Power (mW)	Attenuation Accuracy (dB)
STCA0601N*	DC-6	1	N3~N7	-0.003~ -0.007	1.20	100	±0.5
STCA0602N*	DC-6	2	N3~N9	-0.003~ -0.009	1.20	100	±0.5
STCA0603N*	DC-6	3	N3~N9	-0.003~ -0.009	1.20	100	±0.5
STCA0604N*	DC-6	4	N3~N9	-0.003~ -0.009	1.20	100	±0.5
STCA0605N*	DC-6	5	N3~N9	-0.003~ -0.009	1.20	100	±0.5
STCA0606N*	DC-6	6	N3~N9	-0.003~ -0.009	1.20	100	±0.5
STCA0607N*	DC-6	7	N3~N9	-0.003~ -0.009	1.20	100	±0.5
STCA0608N*	DC-6	8	N3~N9	-0.003~ -0.009	1.20	100	±0.5
STCA0609N*	DC-6	9	N3~N9	-0.003~ -0.009	1.20	100	±0.5
STCA0610N*	DC-6	10	N3~N9	-0.003~ -0.009	1.20	100	±0.5

**General Specifications**

- Frequency Range DC to 6GHz
- Attenuation 3dB
- Attenuation Accuracy at 25 ± 0.5dB@1GHz
- VSWR 1.20:1 Max. @1GHz at 25  
1.20:1 typical @2GHz at 25  
1.20:1 typical @3 GHz at 25
- Nominal Impedance 50 Ohms
- Power Rating 100 mW CW
- Power Derating 100% @ 100  
Derates to 0% @ 150
- Operating Temperature -55 to +150
- Temperature Coefficient over Operating Temperature Range: See Table Above.  
Temperature Coefficient Tolerance: ± 0.001dB/dB/ .
- Substrate: Alumina (Al2O3)
- Resistive material: Thick film
- Terminal material: Thick film, Nickel barrier with pure tin plate (lead free) or with tin (Sn90) plate (10% lead contained)
- Protective Coating: Thick film (ethyl acetate)
- Package Outline: See Sheet 3.
- Workmanship: per MIL-PRF-55342.
- RoHS Compliant.
- Electrostatic Discharge Control: per MIL-STD-1686.

**Unit Marking** dB Value (XX), Direction of Shift (N) and TCA Shift (X).  
Legibility and Permanency: per MIL-STD-130.

**Quality Assurance**

- Sample inspect per ANSI/ASQC Z1.4 general inspection, LEVEL II, AQL = 1.0.
  - Visual and mechanical examination for conformance to outline package requirements.
- Select five (5) Units from lot measure attenuation from DC to 6GHz every 20°C over the temperature range -55°C to +125°C.
  - Calculate, using linear regression, the slope of the curve.
  - Calculate TCA using the following formula: TCA = Slope / Attenuation @ 25°C.
- Test data required for customer.

**Yantel Corporation**

Add : 2F, Building 2, Gaofa Technology Park, LongJing, Nanshan Area, Shenzhen, China  
Tel : 86-755-8355-1886 Fax : 86-755-8355-2533

For detailed performance specs & shopping online see Yantel web site : [www.yantel-corp.com](http://www.yantel-corp.com)

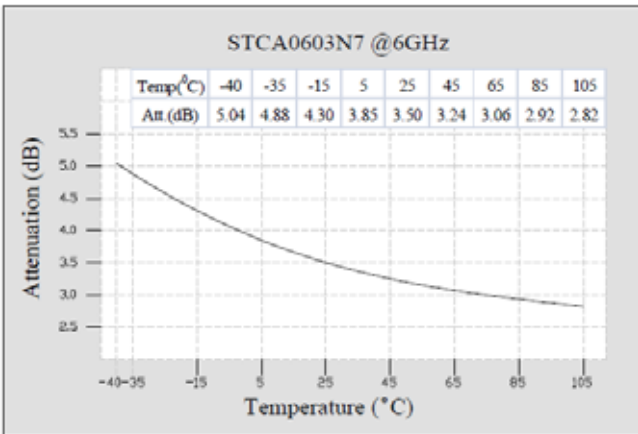
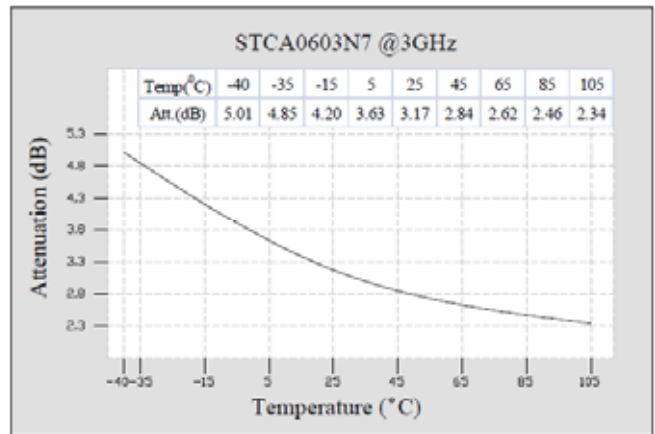
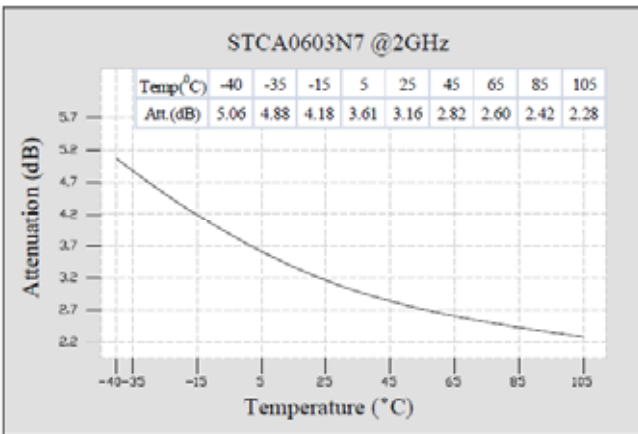
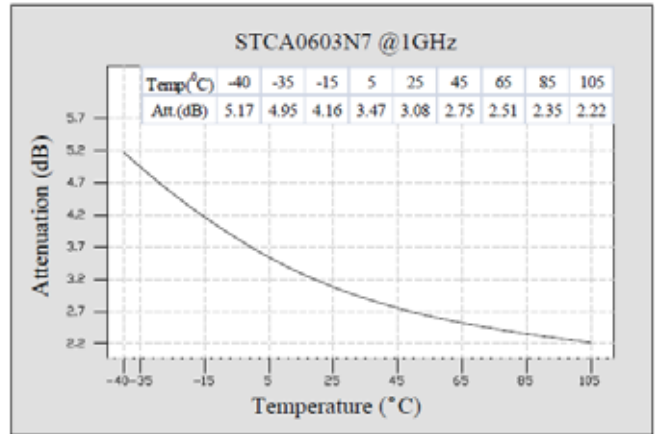
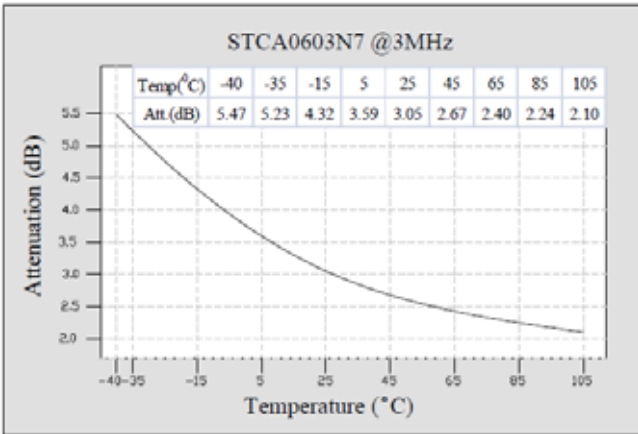
**STCA Response**

**Statistical Table of Attenuation(typ.) VS Temperature**

Temp( ) \ ATT(dB)	3MHz	1GHz	2GHz	3GHz
-40	5.47	5.17	5.06	5.01
-35	5.23	4.95	4.88	4.85
-15	4.32	4.16	4.18	4.20
5	3.59	3.47	3.61	3.63
25	3.05	3.08	3.16	3.17
45	2.67	2.75	2.82	2.84
65	2.40	2.51	2.60	2.62
85	2.24	2.35	2.42	2.46
105	2.10	2.22	2.28	2.34

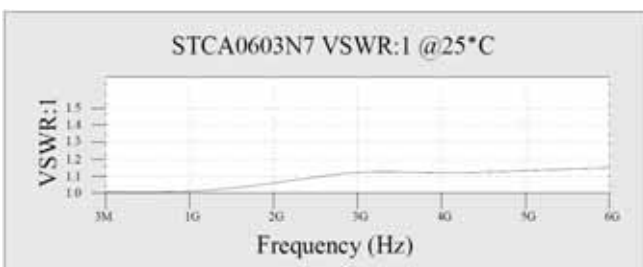
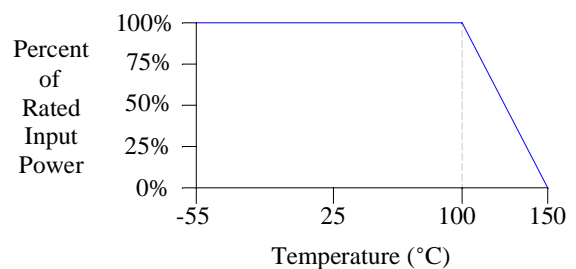
**Typical VSWR @25**

**Power Rating & Derating Curve**

**Package Outlines**

All dimensions shown in mm unless stated otherwise

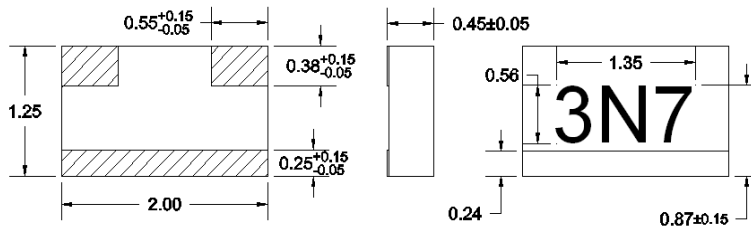
Planar Configuration



**Note:** Dimension tolerance in  $\pm 0.10$  otherwise mention

**Recommended Layout**

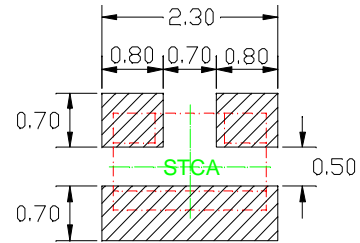
All dimensions shown in mm unless stated otherwise

**Tape & Reel Drawing**

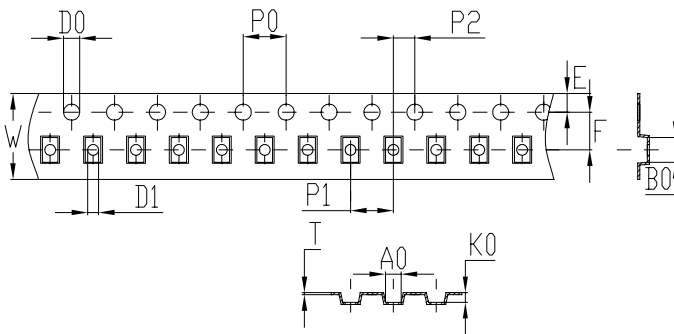
All dimensions shown in mm unless stated otherwise



Notice:

- A.10 Sprocket hole pitch cumulative tolerance is 0.2mm.
- B. Carrier camber shall be not more than 1mm per 100mm through a length of 250mm.
- C. All dimensions meet EIA-418-B requirements.
- D. A0 & B0 measured as indicated.
- E. K0 measured from a place on the inside bottom of the pocket to top surface of carrier.
- F. Material: PE 100
- G. Thickness:  $0.20 \pm 0.05$ mm
- H. 3000 units (maximum) / T&R

symbol	A0	B0	K0	P0	P1	P2
spec	$1.45 \pm 0.1$	$2.30 \pm 0.1$	$0.9 \pm 0.1$	$4.0 \pm 0.1$	$4.0 \pm 0.1$	$2.0 \pm 0.1$
symbol	W	T	E	F	D0	D1
spec	$8.0 \pm 0.1$	$0.20 \pm 0.05$	$1.75 \pm 0.1$	$3.5 \pm 0.1$	$\Phi 1.5^{+0.1}_{-0.0}$	$\Phi 1.0^{+0.1}_{-0.0}$

