



N-Channel Logic Level Enhancement Mode Field Effect Transistor

PRODUCT SUMMARY

V _{DSS}	I _D	R _{DS(ON)} (Ω) Max
100V	2A	0.9 @ V _{GS} =10V
		1.1 @ V _{GS} =4.5V

FEATURES

- Super high dense cell design for low R_{DS(ON)}.
- Rugged and reliable.
- TO-252 and TO-251 Package.
- ESD Protected.

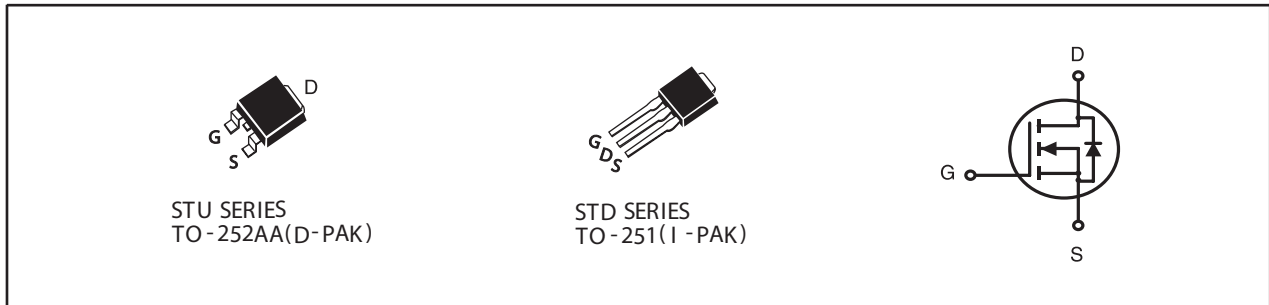

ABSOLUTE MAXIMUM RATINGS (T_C=25°C unless otherwise noted)

Symbol	Parameter	Limit	Units
V _{DS}	Drain-Source Voltage	100	V
V _{GS}	Gate-Source Voltage	±20	V
I _D	Drain Current-Continuous ^{a d}	T _C =25°C	2
		T _C =70°C	1.6
I _{DM}	-Pulsed ^b	5.8	A
P _D	Maximum Power Dissipation	T _C =25°C	42
		T _C =70°C	27
T _J , T _{STG}	Operating Junction and Storage Temperature Range	-55 to 150	°C

THERMAL CHARACTERISTICS

R _{θ JC}	Thermal Resistance, Junction-to-Case	3	°C/W
R _{θ JA}	Thermal Resistance, Junction-to-Ambient	50	°C/W

STU03L01

STD03L01

Ver 1.0

ELECTRICAL CHARACTERISTICS (T_C=25°C unless otherwise noted)

Symbol	Parameter	Conditions	Min	Typ	Max	Units
OFF CHARACTERISTICS						
BV _{DSS}	Drain-Source Breakdown Voltage	V _{GS} =0V , I _D =250uA	100			V
I _{DSS}	Zero Gate Voltage Drain Current	V _{DS} =80V , V _{GS} =0V			1	uA
I _{GSS}	Gate-Body Leakage Current	V _{GS} = ±20V , V _{DS} =0V			±10	uA
ON CHARACTERISTICS						
V _{GS(th)}	Gate Threshold Voltage	V _{DS} =V _{GS} , I _D =250uA	1	2	3	V
R _{DS(ON)}	Drain-Source On-State Resistance	V _{GS} =10V , I _D =1A		0.72	0.9	ohm
		V _{GS} =4.5V , I _D =0.9A		0.81	1.1	ohm
g _{FS}	Forward Transconductance	V _{DS} =10V , I _D =1A		3.5		S
DYNAMIC CHARACTERISTICS ^c						
C _{ISS}	Input Capacitance	V _{DS} =25V, V _{GS} =0V f=1.0MHz		200		pF
C _{OSS}	Output Capacitance			28		pF
C _{RSS}	Reverse Transfer Capacitance			17		pF
SWITCHING CHARACTERISTICS ^c						
t _{D(ON)}	Turn-On Delay Time	V _{DD} =50V I _D =1A V _{GS} =10V R _{GEN} = 6 ohm		20		ns
t _r	Rise Time			19.5		ns
t _{D(OFF)}	Turn-Off Delay Time			178		ns
t _f	Fall Time			46		ns
Q _g	Total Gate Charge		V _{DS} =50V, I _D =1A, V _{GS} =10V		4	
Q _{gs}	Gate-Source Charge	V _{DS} =50V, I _D =1A, V _{GS} =10V		1		nC
Q _{gd}	Gate-Drain Charge			1.4		nC
DRAIN-SOURCE DIODE CHARACTERISTICS AND MAXIMUM RATINGS						
V _{SD}	Diode Forward Voltage	V _{GS} =0V, I _S =1A		0.88	1.3	V

Notes

- Surface Mounted on FR4 Board, t ≤ 10sec.
- Pulse Test: Pulse Width ≤ 300us, Duty Cycle ≤ 2%.
- Guaranteed by design, not subject to production testing.
- Drain current limited by maximum junction temperature.

Jul,03,2013

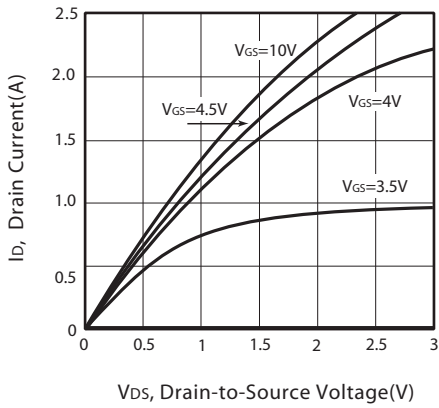

Figure 1. Output Characteristics

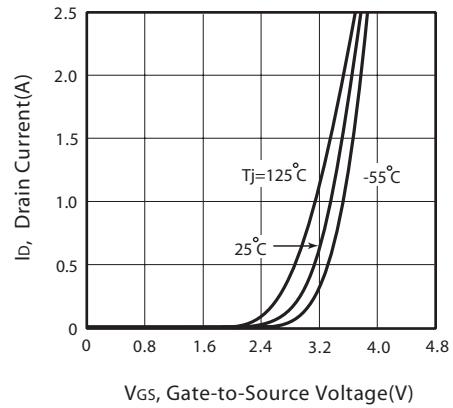

Figure 2. Transfer Characteristics

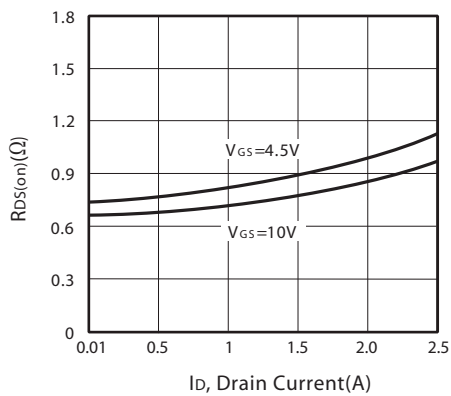

Figure 3. On-Resistance vs. Drain Current and Gate Voltage

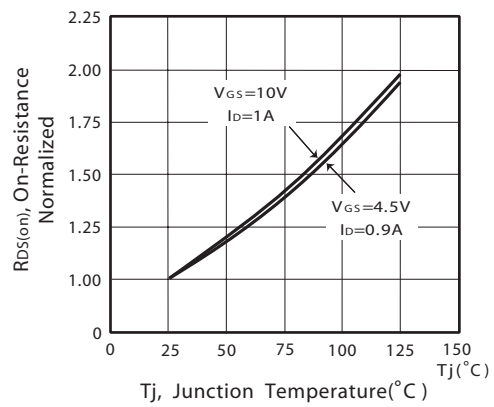

Figure 4. On-Resistance Variation with Drain Current and Temperature

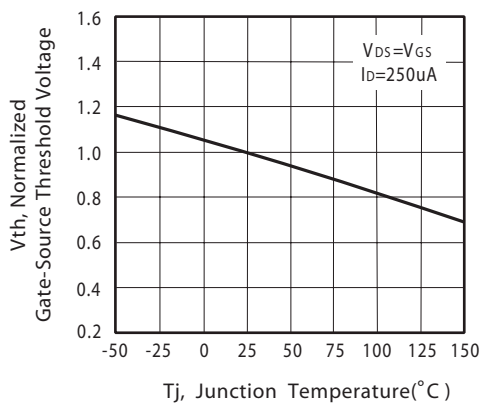

Figure 5. Gate Threshold Variation with Temperature

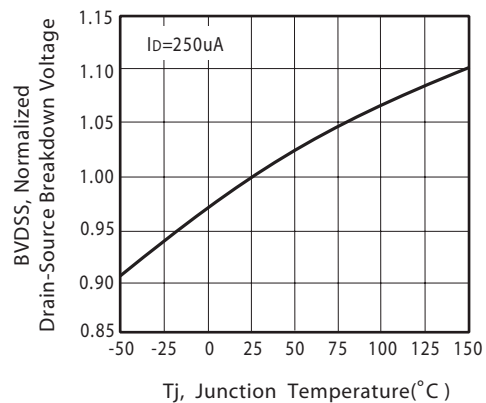

Figure 6. Breakdown Voltage Variation with Temperature

STU03L01 STD03L01

Ver 1.0

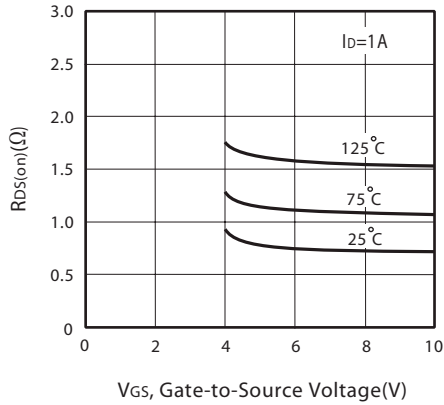

Figure 7. On-Resistance vs. Gate-Source Voltage

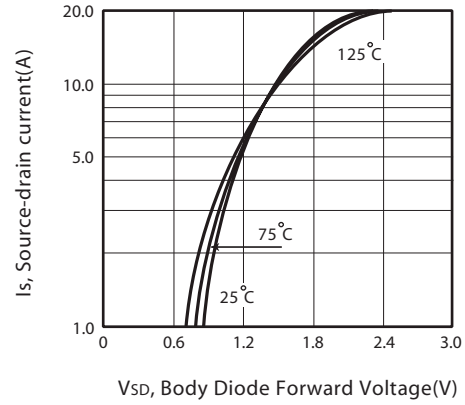

Figure 8. Body Diode Forward Voltage Variation with Source Current

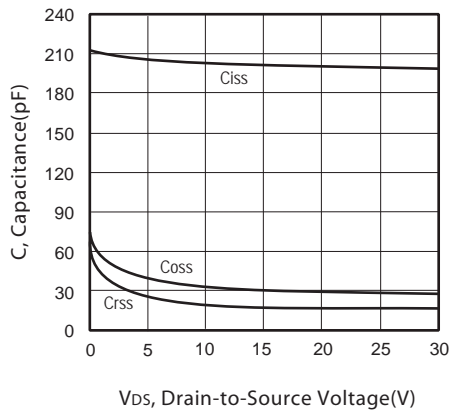

Figure 9. Capacitance

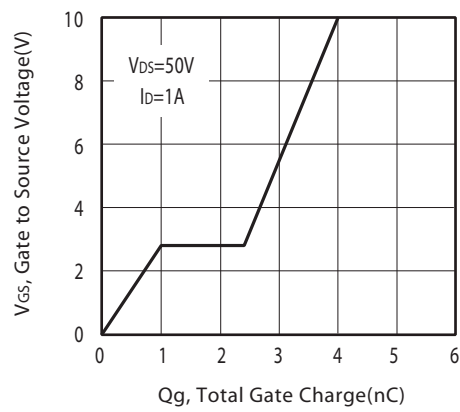

Figure 10. Gate Charge

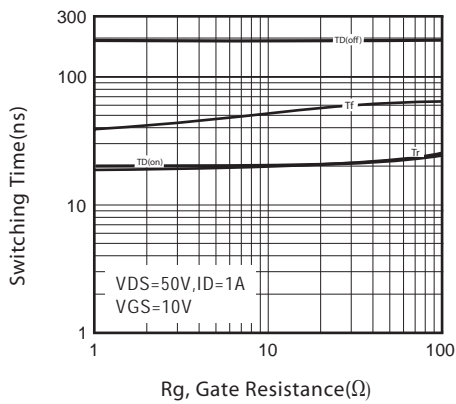

Figure 11. switching characteristics

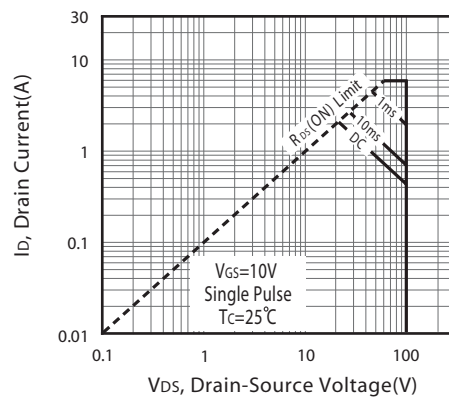

Figure 12. Maximum Safe Operating Area

Jul,03,2013

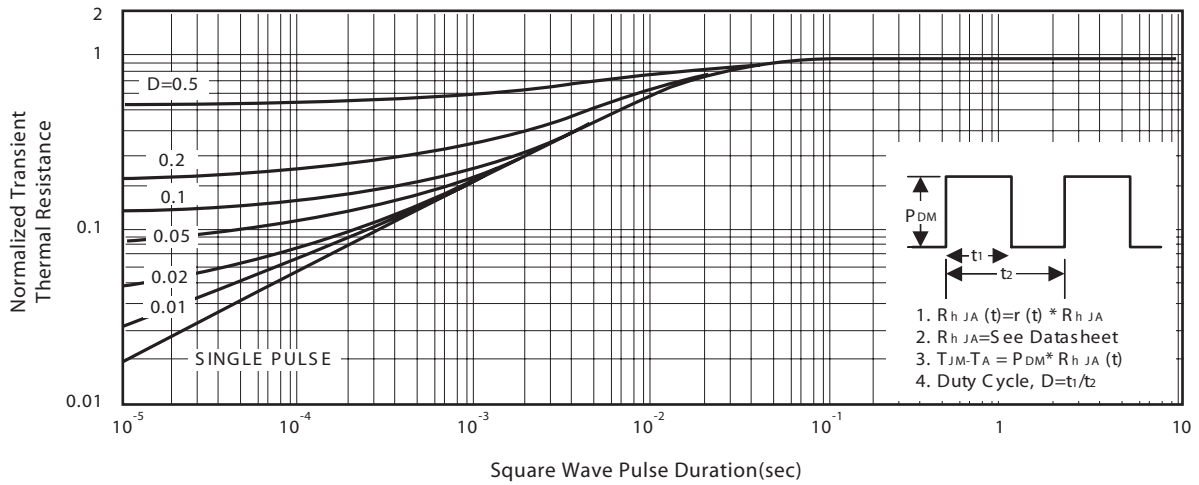
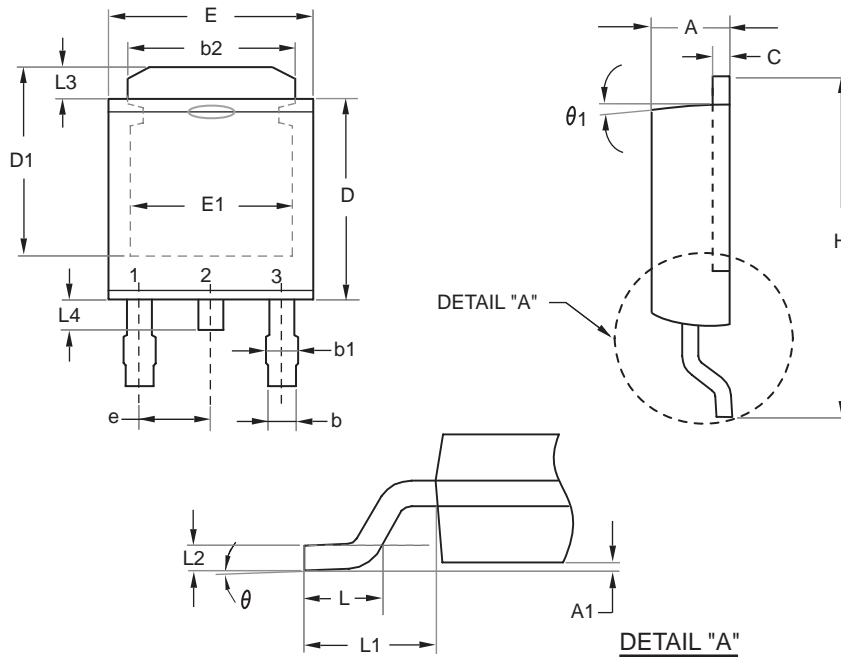

Figure 13. Normalized Thermal Transient Impedance Curve

STU03L01 STD03L01

Ver 1.0

TO-252



SYMBOLS	MILLIMETERS		INCHES	
	MIN	MAX	MIN	MAX
A	2.100	2.500	0.083	0.098
A1	0.000	0.200	0.000	0.008
b	0.400	0.889	0.016	0.035
b1	0.770	1.140	0.030	0.045
b2	4.800	5.460	0.189	0.215
C	0.400	0.600	0.016	0.024
D	5.300	6.223	0.209	0.245
D1	4.900	5.515	0.193	0.217
E	6.300	6.731	0.248	0.265
E1	4.400	5.004	0.173	0.197
e	2.290 REF		0.090 BSC	
H	8.900	10.400	0.350	0.409
L	1.397	1.770	0.055	0.070
L1	2.743 REF.		0.108 REF.	
L2	0.508 REF.		0.020 REF.	
L3	0.890	1.700	0.035	0.067
L4	0.500	1.100	0.020	0.043
theta	0°	10°	0°	10°
theta1	7° REF.		7° REF.	

Jul,03,2013

STU03L01 STD03L01

Ver 1.0

PACKAGE OUTLINE DIMENSIONS

TO-251

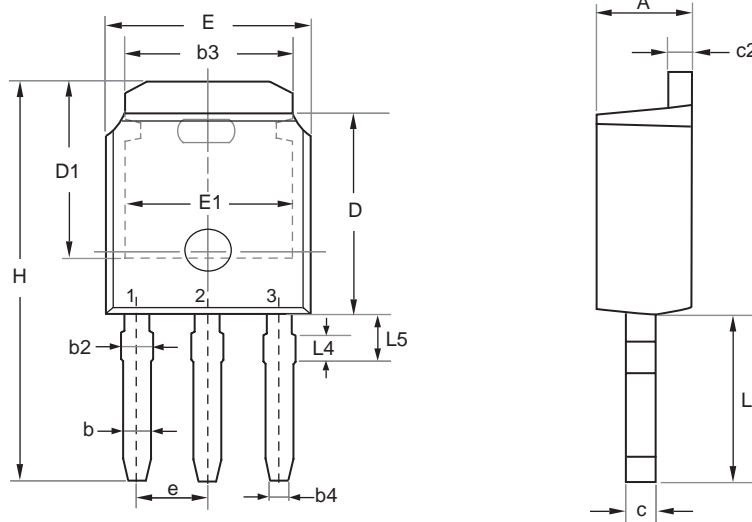

SYMBOL	MILLIMETERS		INCHES	
	MIN	MAX	MIN	MAX
E	6.400	6.731	0.252	0.265
L	3.980	4.280	0.157	0.169
L4	0.698 REF		0.027 REF	
L5	0.972	1.226	0.038	0.048
D	6.000	6.223	0.236	0.245
H	11.050	11.450	0.435	0.450
b	0.640	0.880	0.025	0.035
b2	0.770	1.140	0.030	0.045
b3	5.210	5.460	0.205	0.215
b4	0.450	0.550	0.018	0.022
e	2.286 BSC		0.090 BSC	
A	2.200	2.380	0.087	0.094
c	0.400	0.600	0.016	0.024
c2	0.400	0.600	0.016	0.024
D1	5.100	---	0.201	---
E1	4.400	---	0.173	---

Jul,03,2013

STU03L01 STD03L01

Ver 1.0

TO-251 Tube/TO-252 Tape and Reel Data

TO-251 Tube

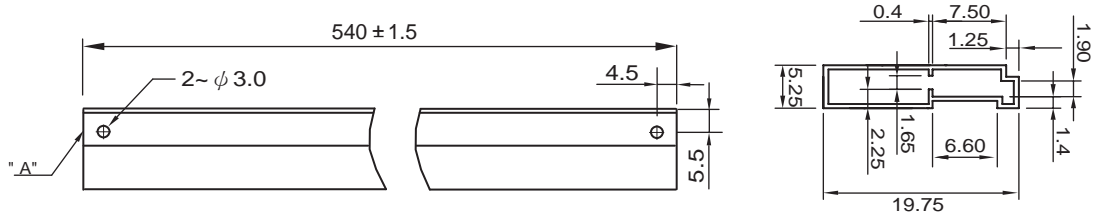

TO-252 Carrier Tape

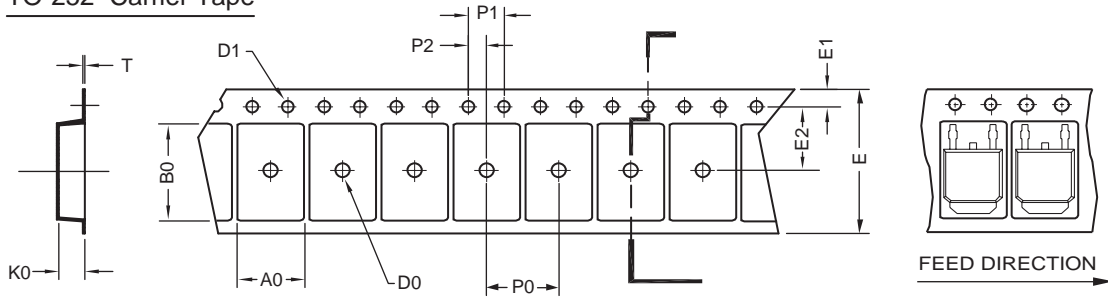

UNIT:mm

PACKAGE	A0	B0	K0	D0	D1	E	E1	E2	P0	P1	P2	T
TO-252 (16 mm)	6.96 ±0.1	10.49 ±0.1	2.79 ±0.1	φ 2	φ 1.5 +0.1 - 0	16.0 ±0.3	1.75 ±0.1	7.5 ±0.15	8.0 ±0.1	4.0 ±0.1	2.0 ±0.15	0.3 ±0.05

TO-252 Reel

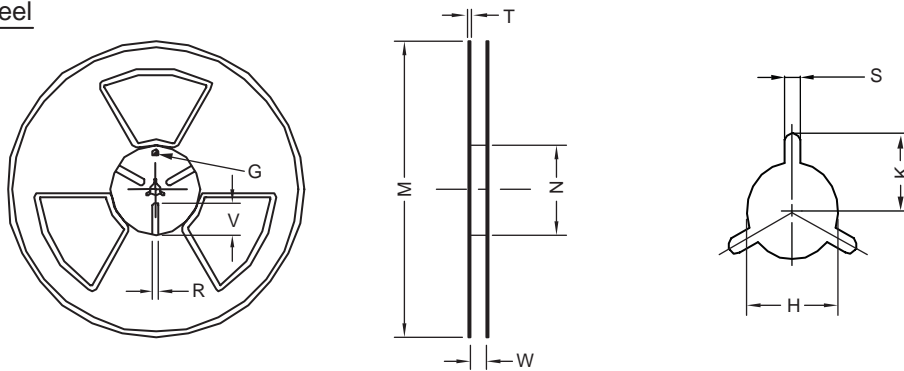

UNIT:mm

TAPE SIZE	REEL SIZE	M	N	W	T	H	K	S	G	R	V
16 mm	φ 330	φ 330 ± 0.5	φ 97 ± 1.0	17.0 + 1.5 - 0	2.2	φ 13.0 + 0.5 - 0.2	10.6	2.0 ±0.5	---	---	---

Jul,03,2013

STU03L01 STD03L01

Ver 1.0

TOP MARKING DEFINITION

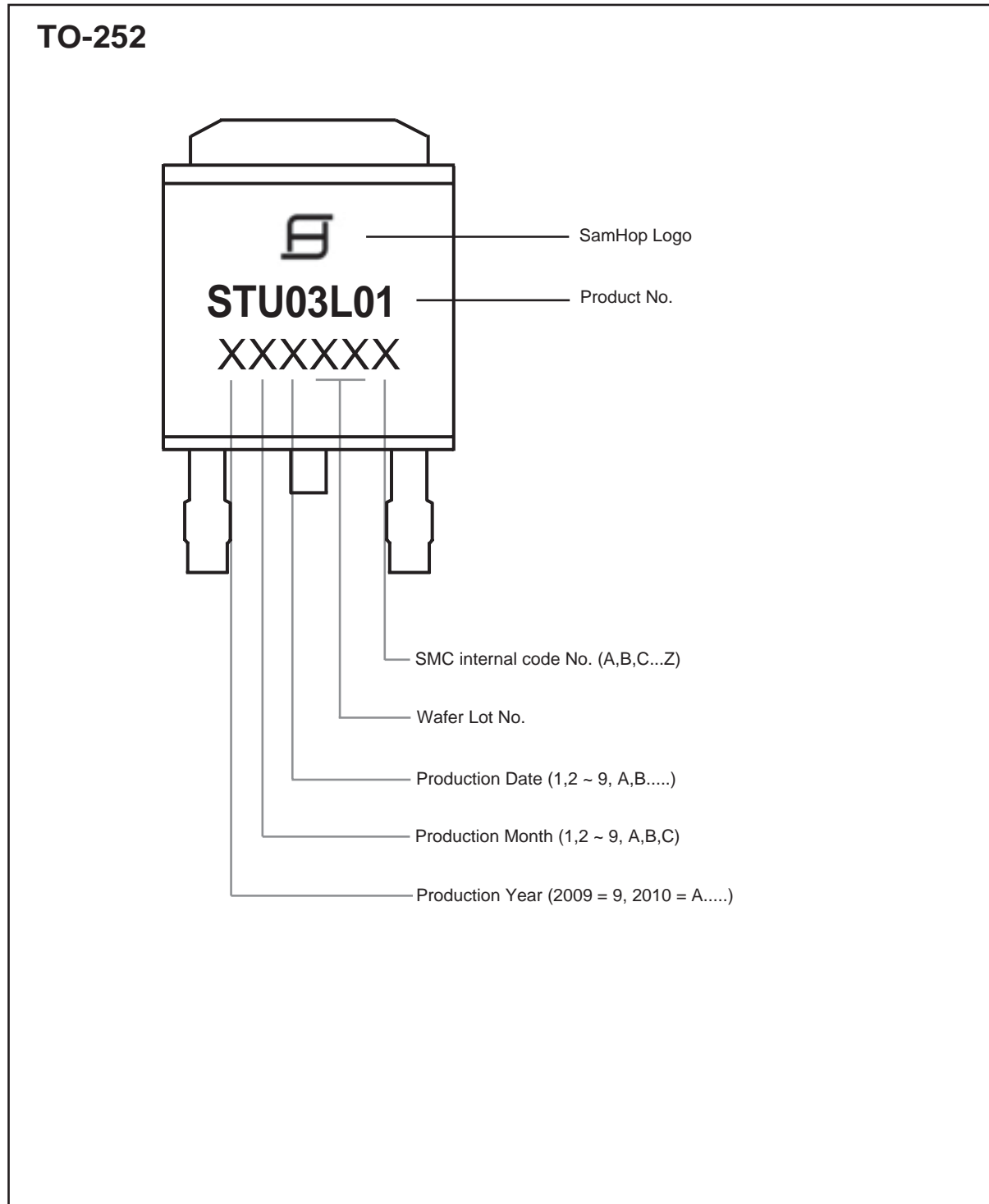

Jul,03,2013

STU03L01 STD03L01

Ver 1.0

TOP MARKING DEFINITION

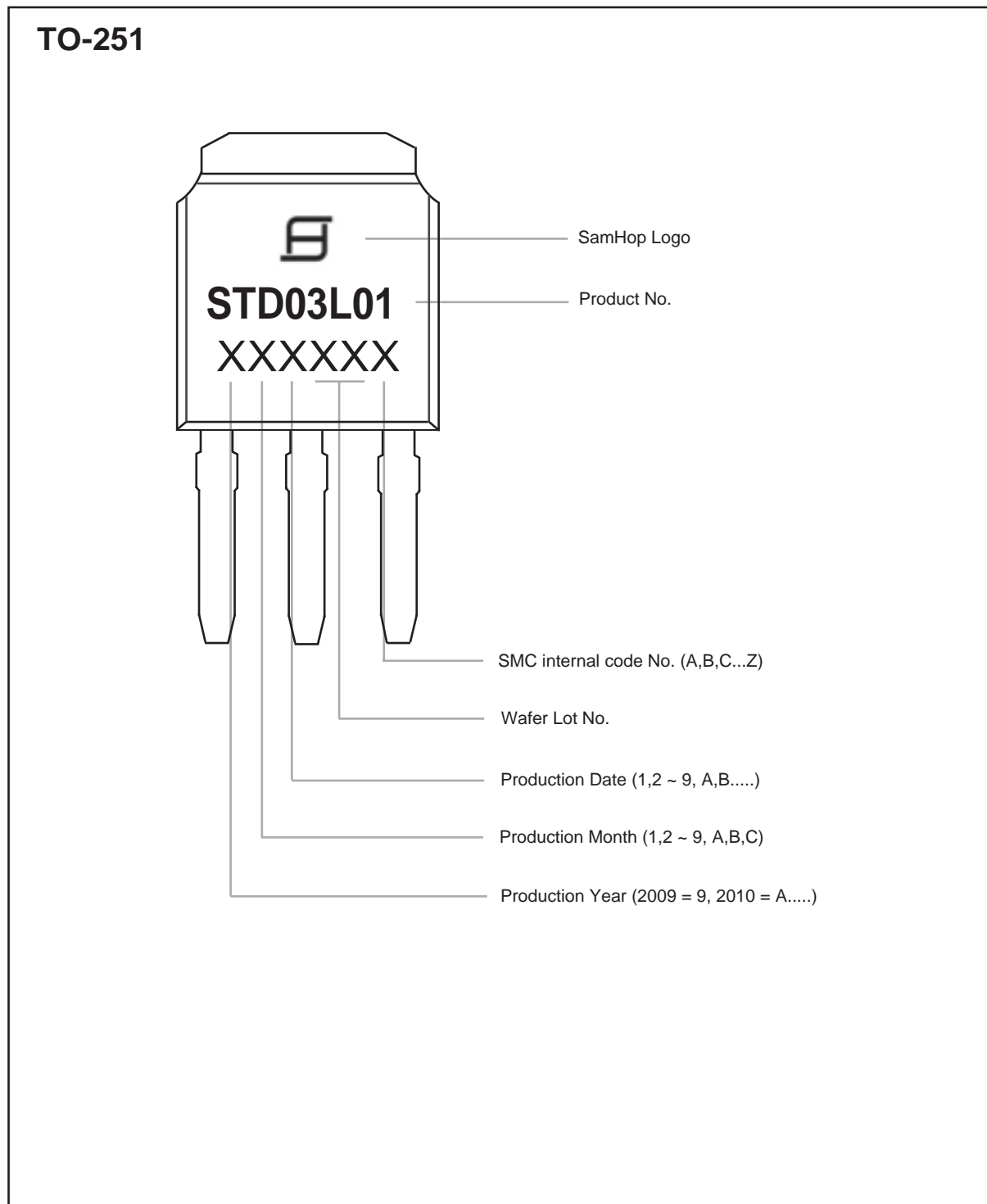

Jul,03,2013