



N-Channel Logic Level Enhancement Mode Field Effect Transistor

PRODUCT SUMMARY

V _{DSS}	I _D	R _{DS(ON)} (mΩ) Max
150V	20A	94 @ V _{GS} =10V

FEATURES

- Super high dense cell design for low R_{DS(ON)}.
- Rugged and reliable.
- TO-252 and TO-251 Package.

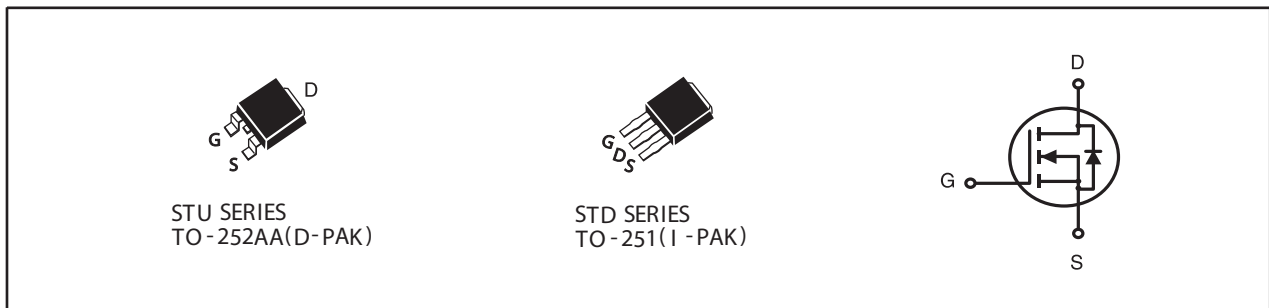

ABSOLUTE MAXIMUM RATINGS (T_C=25°C unless otherwise noted)

Symbol	Parameter	Limit	Units
V _{DS}	Drain-Source Voltage	150	V
V _{GS}	Gate-Source Voltage	±20	V
I _D	Drain Current-Continuous ^c	T _C =25°C	20
		T _C =70°C	16.7
I _{DM}	-Pulsed ^{a,c}	59	A
E _{AS}	Single Pulse Avalanche Energy ^d	4	mJ
P _D	Maximum Power Dissipation	T _C =25°C	75
		T _C =70°C	52.5
T _J , T _{STG}	Operating Junction and Storage Temperature Range	-55 to 175	°C

THERMAL CHARACTERISTICS

R _{θJC}	Thermal Resistance, Junction-to-Case	2	°C/W
R _{θJA}	Thermal Resistance, Junction-to-Ambient	50	°C/W

STU1554

STD1554

Ver 1.0

ELECTRICAL CHARACTERISTICS (T_C=25°C unless otherwise noted)

Symbol	Parameter	Conditions	Min	Typ	Max	Units
OFF CHARACTERISTICS						
BV _{DSS}	Drain-Source Breakdown Voltage	V _{GS} =0V , I _D =250uA	150			V
I _{DSS}	Zero Gate Voltage Drain Current	V _{DS} =120V , V _{GS} =0V			1	uA
I _{GSS}	Gate-Body Leakage Current	V _{GS} = ±20V , V _{DS} =0V			±100	nA
ON CHARACTERISTICS						
V _{GS(th)}	Gate Threshold Voltage	V _{DS} =V _{GS} , I _D =250uA	2	3	4	V
R _{DS(ON)}	Drain-Source On-State Resistance	V _{GS} =10V , I _D =10A		78	94	m ohm
g _{FS}	Forward Transconductance	V _{DS} =10V , I _D =10A		30		S
DYNAMIC CHARACTERISTICS^b						
C _{ISS}	Input Capacitance	V _{DS} =25V, V _{GS} =0V f=1.0MHz		1360		pF
C _{OSS}	Output Capacitance			90		pF
C _{RSS}	Reverse Transfer Capacitance			61		pF
SWITCHING CHARACTERISTICS^b						
t _{D(ON)}	Turn-On Delay Time	V _{DD} =75V I _D =1A V _{GS} =10V R _{GEN} = 6 ohm		26		ns
t _r	Rise Time			24		ns
t _{D(OFF)}	Turn-Off Delay Time			47		ns
t _f	Fall Time			10		ns
Q _g	Total Gate Charge	V _{DS} =75V, I _D =10A, V _{GS} =10V		19		nC
Q _{gs}	Gate-Source Charge	V _{DS} =75V, I _D =10A, V _{GS} =10V		3		nC
Q _{gd}	Gate-Drain Charge			6.5		nC
DRAIN-SOURCE DIODE CHARACTERISTICS AND MAXIMUM RATINGS						
V _{SD}	Diode Forward Voltage	V _{GS} =0V, I _S =5A		0.78	1.3	V
Notes						
<p>a. Pulse Test: Pulse Width ≤ 10us, Duty Cycle ≤ 1%.</p> <p>b. Guaranteed by design, not subject to production testing.</p> <p>c. Drain current limited by maximum junction temperature.</p> <p>d. Starting T_J=25°C, L=0.5mH, V_{DD} = 50V. (See Figure13)</p> <p>e. Mounted on FR4 Board of 1 inch² , 2oz.</p>						

May,22,2015

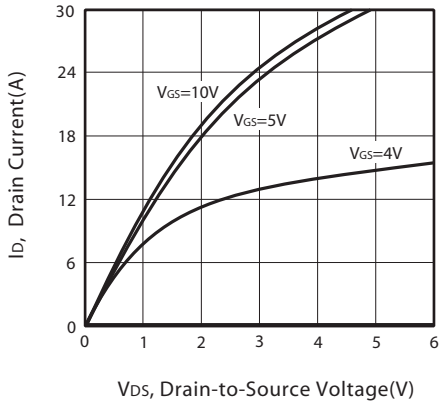

Figure 1. Output Characteristics

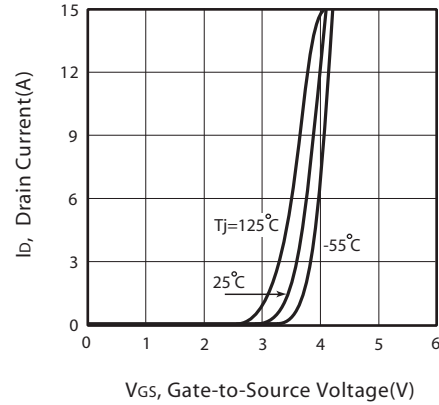

Figure 2. Transfer Characteristics

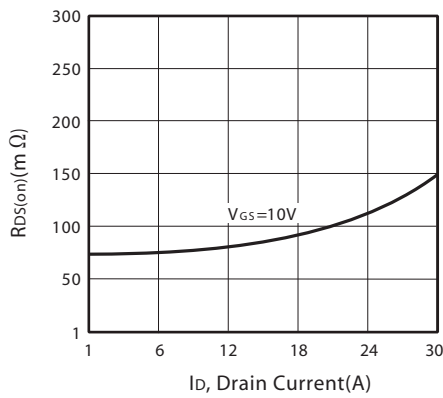

Figure 3. On-Resistance vs. Drain Current and Gate Voltage

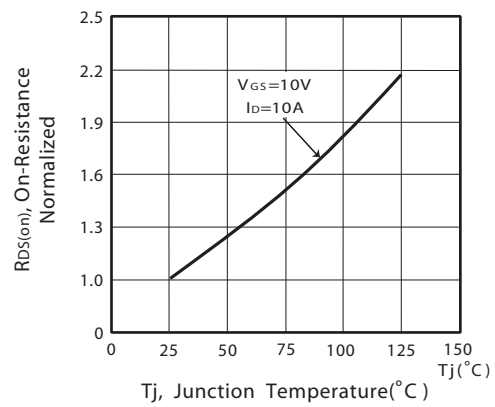

Figure 4. On-Resistance Variation with Drain Current and Temperature

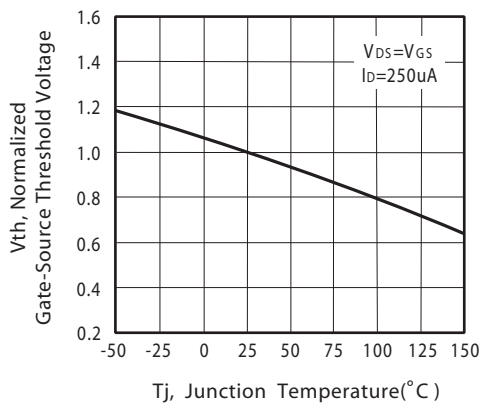

Figure 5. Gate Threshold Variation with Temperature

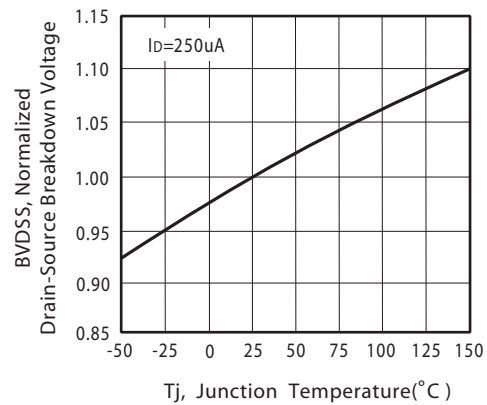

Figure 6. Breakdown Voltage Variation with Temperature

STU1554 STD1554

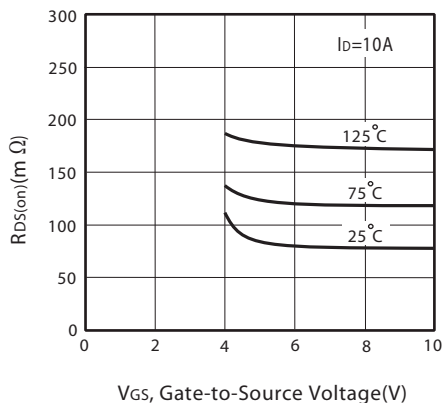

Figure 7. On-Resistance vs. Gate-Source Voltage

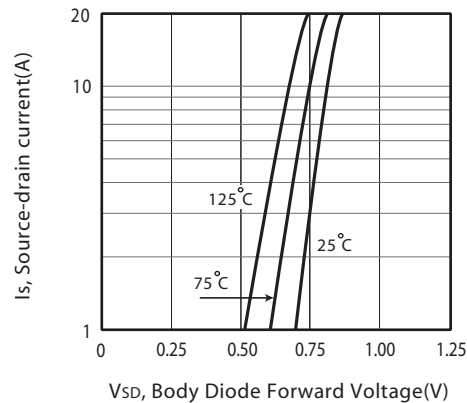

Figure 8. Body Diode Forward Voltage Variation with Source Current

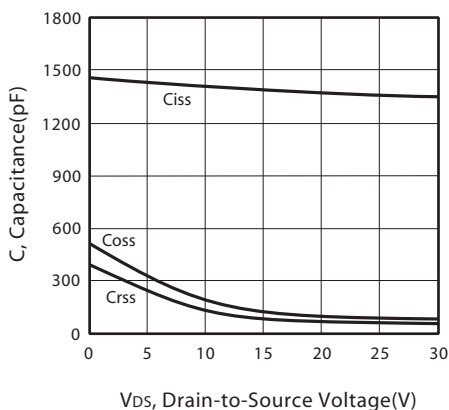

Figure 9. Capacitance

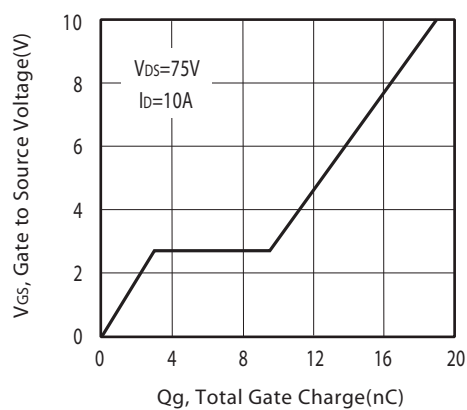

Figure 10. Gate Charge

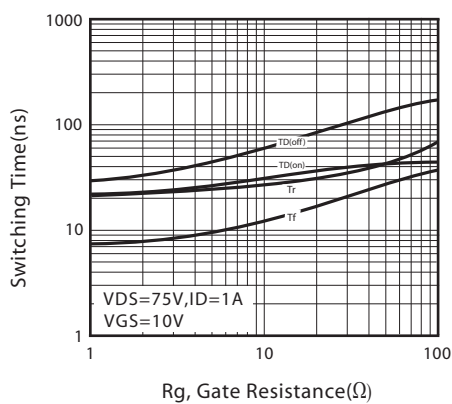

Figure 11. switching characteristics

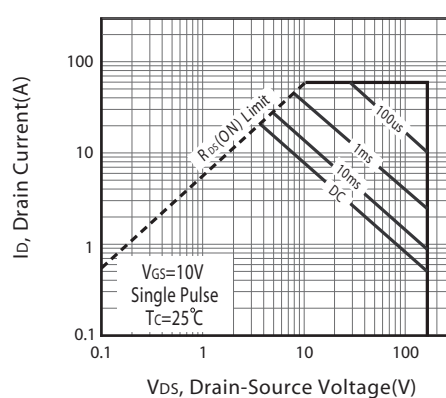
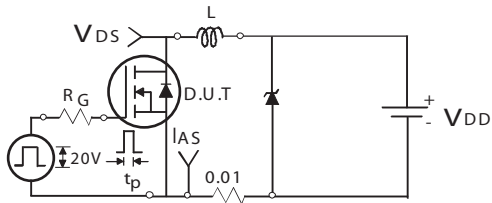

Figure 12. Maximum Safe Operating Area

STU1554 STD1554



Unclamped Inductive Test Circuit

Figure 13a.

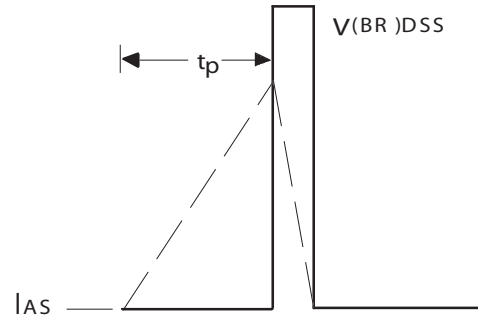

Unclamped Inductive Waveforms

Figure 13b.

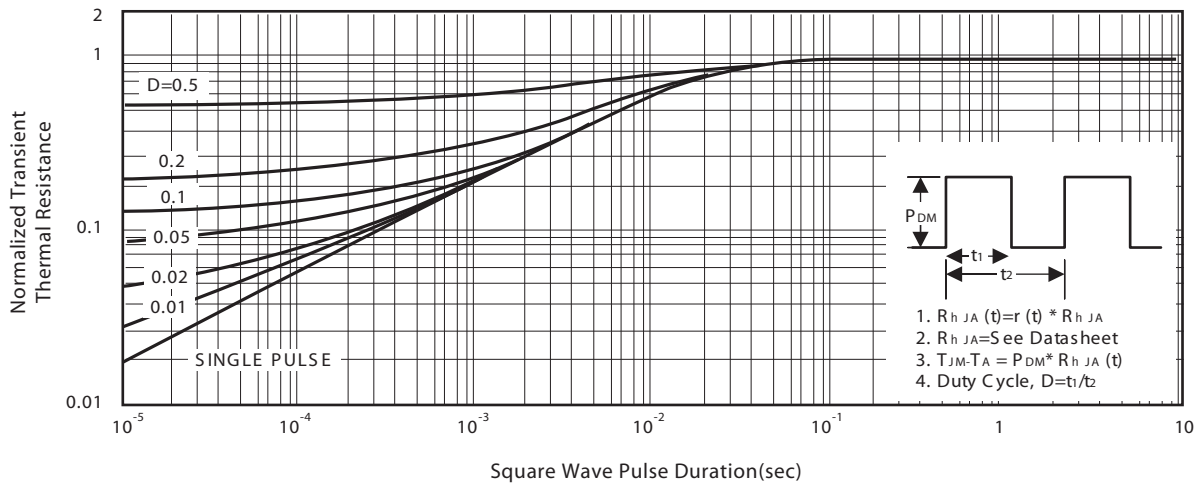
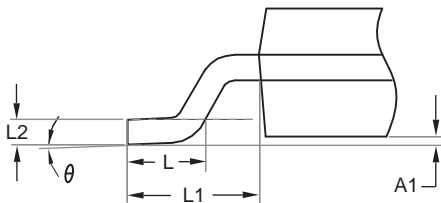
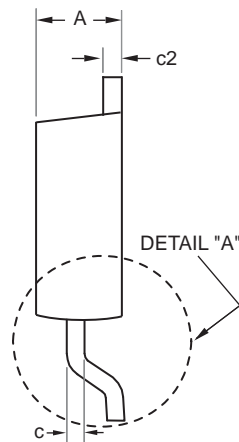
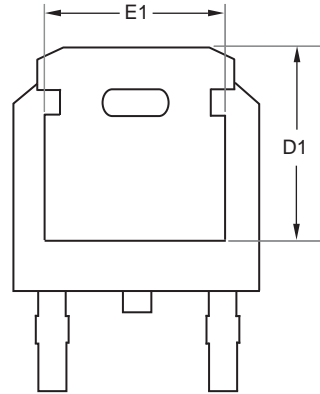
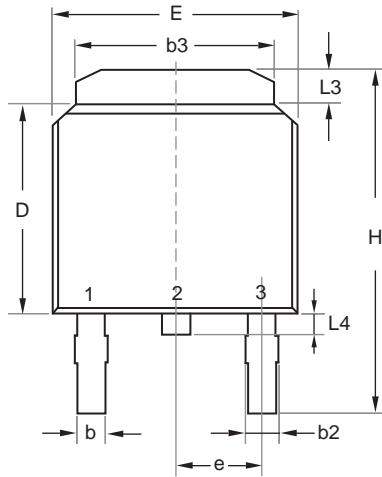

Figure 14. Normalized Thermal Transient Impedance Curve

STU1554 STD1554

Ver 1.0

TO-252



DETAIL "A"

SYMBOLS	MILLIMETERS	
	MIN	MAX
A	2.200	2.380
A1	0.000	0.127
b	0.635	0.889
b2	0.762	1.143
b3	5.200	5.460
c	0.450	0.600
c2	0.450	0.580
D	6.000	6.223
D1	5.210	5.380
e	2.286 BSC	
E	6.400	6.731
E1	4.318	4.900
H	9.400	10.400
L	1.400	1.770
L1	2.743 REF	
L2	0.508 BSC	
L3	0.890	1.270
L4	0.640	1.010
θ	0°	10°

May,22,2015

STU1554 STD1554

Ver 1.0

PACKAGE OUTLINE DIMENSIONS

TO-251

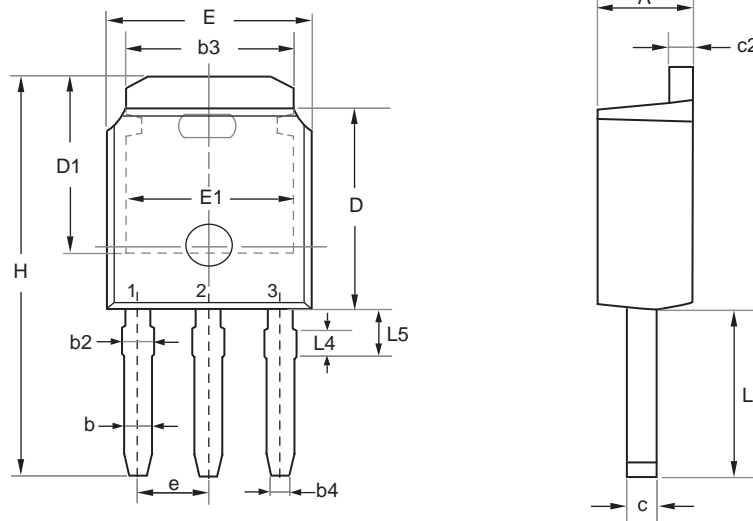

SYMBOL	MILLIMETERS	
	MIN	MAX
E	6.350	6.731
L	3.700	4.400
L4	0.698 REF	
L5	0.972	1.226
D	5.970	6.223
H	9.670	11.450
b	0.630	0.850
b2	0.760	1.140
b3	4.950	5.460
b4	0.450	0.550
e	2.286 BSC	
A	2.180	2.390
c	0.400	0.610
c2	0.400	0.610
D1	5.100	---
E1	4.318	---

May,22,2015

STU1554 STD1554

Ver 1.0

TO-251 Tube/TO-252 Tape and Reel Data

TO-251 Tube

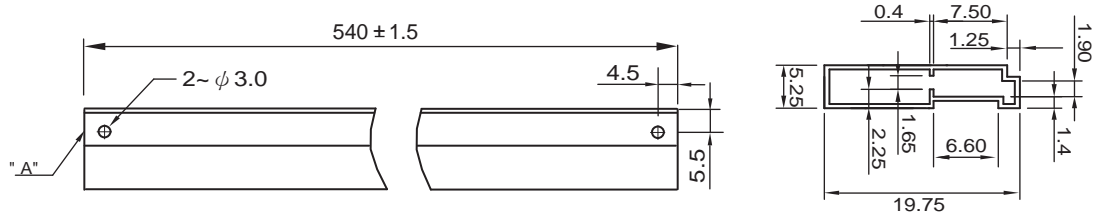

TO-252 Carrier Tape

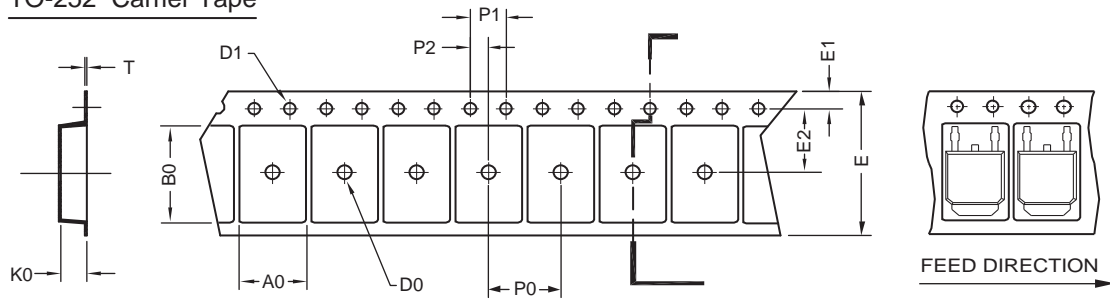

UNIT:mm

PACKAGE	A0	B0	K0	D0	D1	E	E1	E2	P0	P1	P2	T
TO-252 (16 mm)	6.96 ±0.1	10.49 ±0.1	2.79 ±0.1	φ 2	φ 1.5 +0.1 - 0	16.0 ±0.3	1.75 ±0.1	7.5 ±0.15	8.0 ±0.1	4.0 ±0.1	2.0 ±0.15	0.3 ±0.05

TO-252 Reel

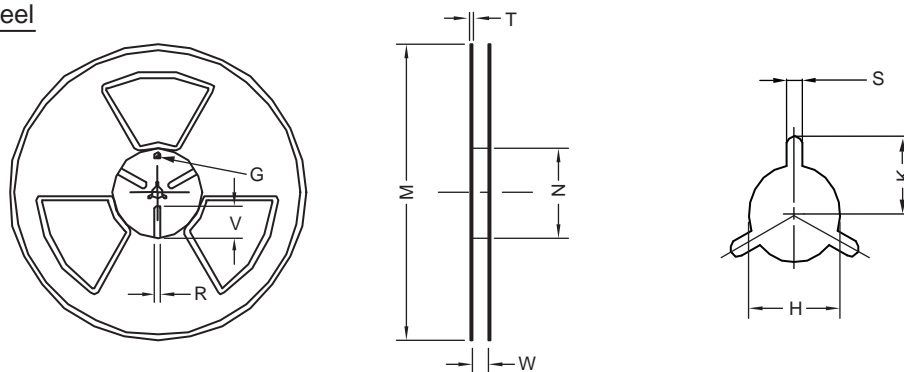

UNIT:mm

TAPE SIZE	REEL SIZE	M	N	W	T	H	K	S	G	R	V
16 mm	φ 330	φ 330 ± 0.5	φ 97 ± 1.0	17.0 + 1.5 - 0	2.2	φ 13.0 + 0.5 - 0.2	10.6	2.0 ±0.5	---	---	---

May,22,2015

STU1554 STD1554

Ver 1.0

TOP MARKING DEFINITION

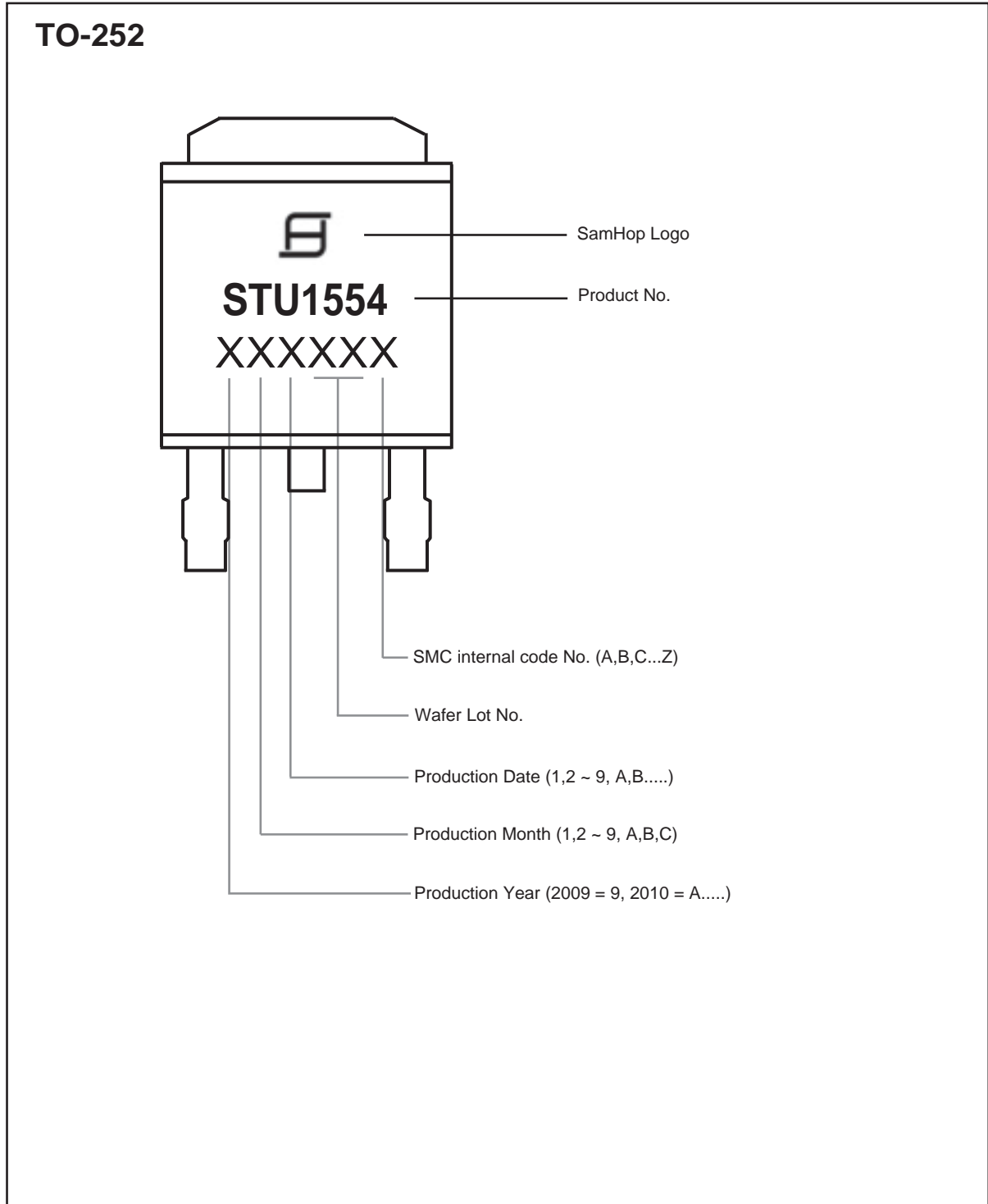

May,22,2015

STU1554 STD1554

TOP MARKING DEFINITION

