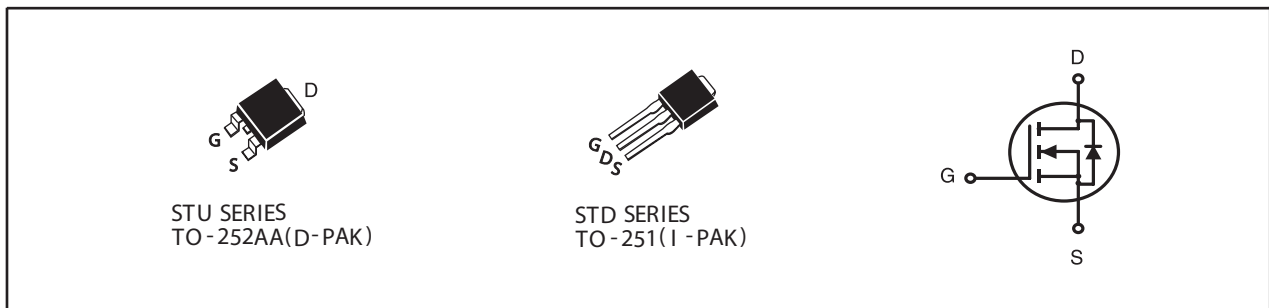

**N-Channel Logic Level Enhancement Mode Field Effect Transistor****PRODUCT SUMMARY**

VDSS	ID	RDS(ON) (mΩ) Max
100V	13A	98 @ VGS=10V
		118 @ VGS=4.5V

FEATURES

- Super high dense cell design for low RDS(ON).
- Rugged and reliable.
- TO-252 and TO-251 Package.

**ABSOLUTE MAXIMUM RATINGS (TC=25°C unless otherwise noted)**

Symbol	Parameter	Limit	Units
V _{DS}	Drain-Source Voltage	100	V
V _{GS}	Gate-Source Voltage	±20	V
I _D	Drain Current-Continuous	T _C =25°C	13
		T _C =70°C	10.4
I _{DM}	-Pulsed ^a	38	A
E _{AS}	Single Pulse Avalanche Energy ^c	56	mJ
P _D	Maximum Power Dissipation	T _C =25°C	42
		T _C =70°C	27
T _J , T _{STG}	Operating Junction and Storage Temperature Range	-55 to 150	°C

THERMAL CHARACTERISTICS

R _{θJC}	Thermal Resistance, Junction-to-Case	3	°C/W
R _{θJA}	Thermal Resistance, Junction-to-Ambient	50	°C/W

STU/D16L01

Ver 1.0

ELECTRICAL CHARACTERISTICS (T_C=25°C unless otherwise noted)

Symbol	Parameter	Conditions	Min	Typ	Max	Units
OFF CHARACTERISTICS						
BV _{DSS}	Drain-Source Breakdown Voltage	V _{GS} =0V , I _D =250uA	100			V
I _{DSS}	Zero Gate Voltage Drain Current	V _{DS} =80V , V _{GS} =0V			1	uA
I _{GSS}	Gate-Body Leakage Current	V _{GS} = ±20V , V _{DS} =0V			±100	nA
ON CHARACTERISTICS						
V _{GS(th)}	Gate Threshold Voltage	V _{DS} =V _{GS} , I _D =250uA	1	1.7	3	V
R _{DS(ON)}	Drain-Source On-State Resistance	V _{GS} =10V , I _D =6.5A		78	98	m ohm
		V _{GS} =4.5V , I _D =5.9A		87	118	m ohm
g _{FS}	Forward Transconductance	V _{DS} =10V , I _D =6.5A		18		S
DYNAMIC CHARACTERISTICS^b						
C _{ISS}	Input Capacitance	V _{DS} =25V, V _{GS} =0V f=1.0MHz		1005		pF
C _{OSS}	Output Capacitance			62		pF
C _{RSS}	Reverse Transfer Capacitance			43		pF
SWITCHING CHARACTERISTICS^b						
t _{D(ON)}	Turn-On Delay Time	V _{DD} =50V I _D =1A V _{GS} =10V R _{GEN} = 6 ohm		16		ns
t _r	Rise Time			15		ns
t _{D(OFF)}	Turn-Off Delay Time			40		ns
t _f	Fall Time			9		ns
Q _g	Total Gate Charge	V _{DS} =50V, I _D =6.5A, V _{GS} =10V		15		nC
		V _{DS} =50V, I _D =6.5A, V _{GS} =4.5V		7.5		nC
Q _{gs}	Gate-Source Charge	V _{DS} =50V, I _D =6.5A,		1.6		nC
Q _{gd}	Gate-Drain Charge	V _{GS} =10V		4.2		nC
DRAIN-SOURCE DIODE CHARACTERISTICS AND MAXIMUM RATINGS						
V _{SD}	Diode Forward Voltage	V _{GS} =0V, I _S =3A		0.81	1.3	V

Notes

- Pulse Test: Pulse Width < 300us, Duty Cycle < 2%.
- Guaranteed by design, not subject to production testing.
- Starting T_J=25°C, L=0.5mH, V_{DD} = 50V. (See Figure13)

Jan,23,2013

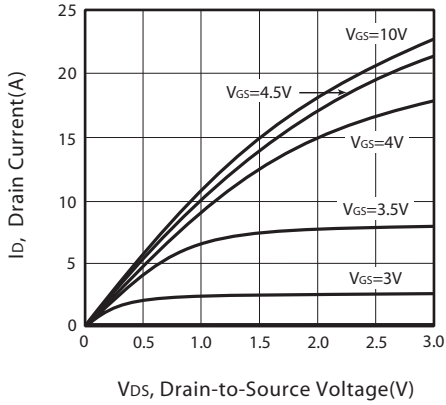

Figure 1. Output Characteristics

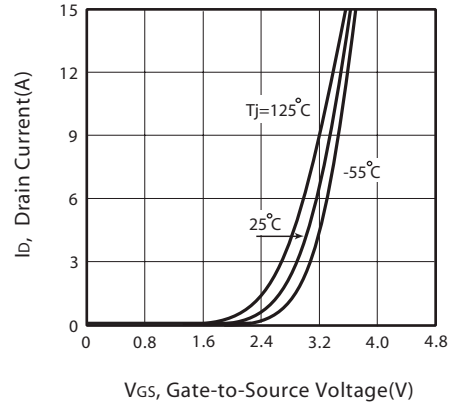

Figure 2. Transfer Characteristics

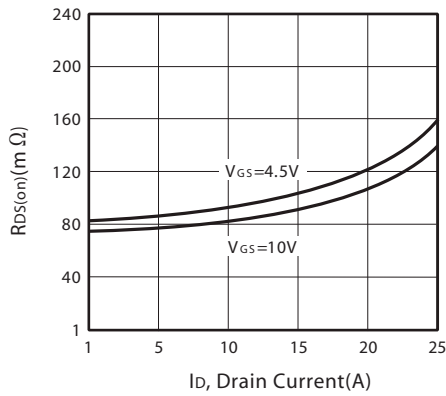

Figure 3. On-Resistance vs. Drain Current and Gate Voltage

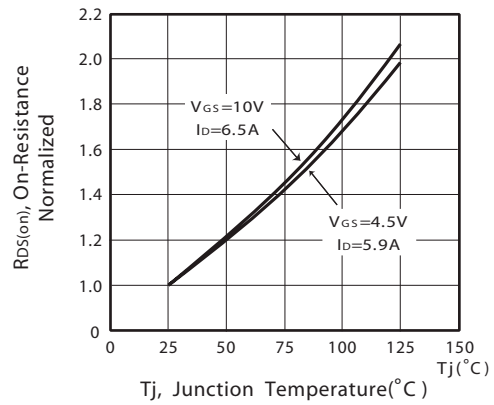

Figure 4. On-Resistance Variation with Drain Current and Temperature

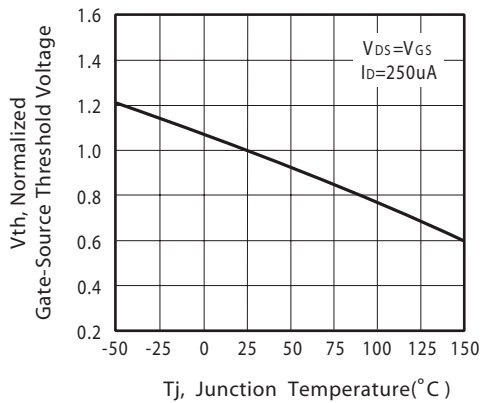

Figure 5. Gate Threshold Variation with Temperature

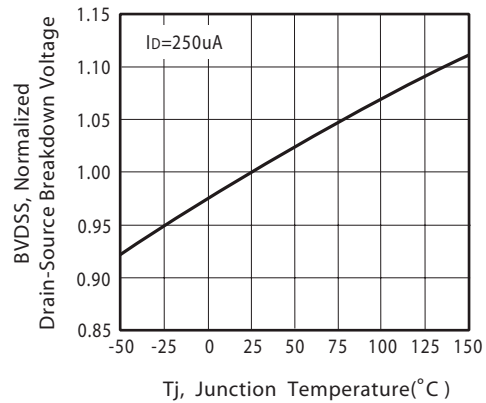

Figure 6. Breakdown Voltage Variation with Temperature

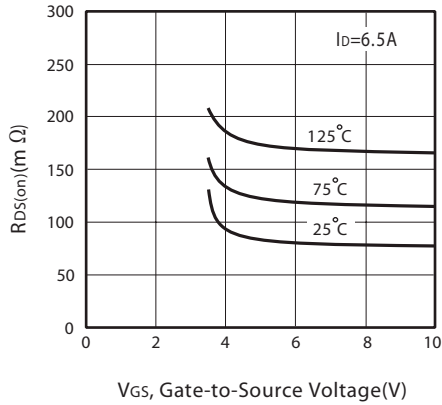

Figure 7. On-Resistance vs. Gate-Source Voltage

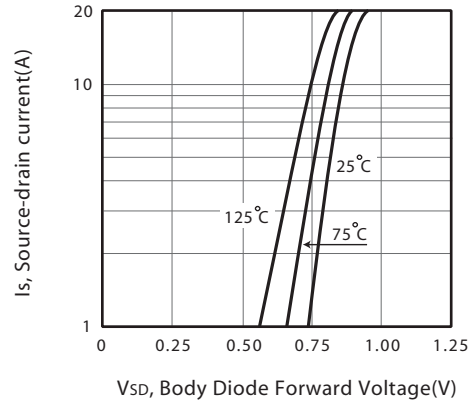

Figure 8. Body Diode Forward Voltage Variation with Source Current

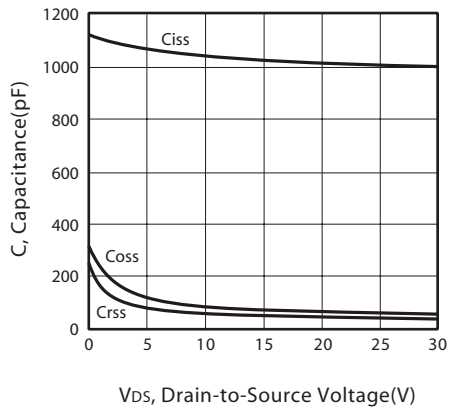

Figure 9. Capacitance

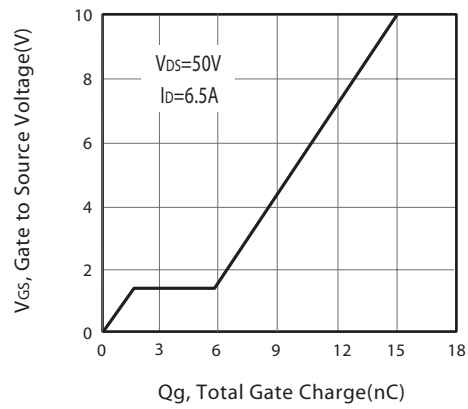

Figure 10. Gate Charge

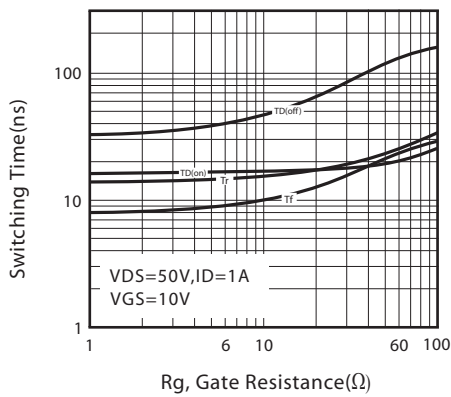

Figure 11. switching characteristics

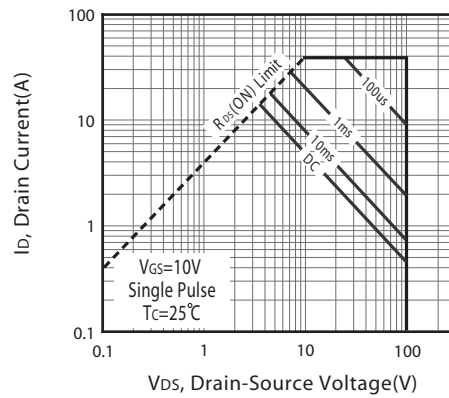
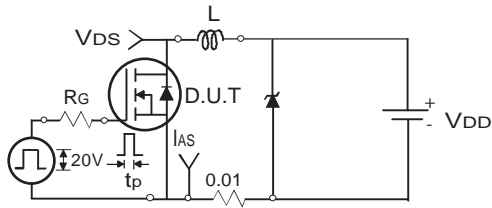
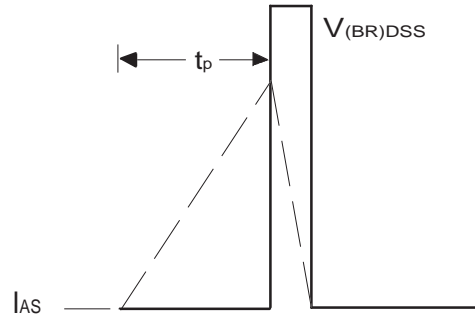

Figure 12. Maximum Safe Operating Area



Uncamped Inductive Test Circuit

Figure 13a.



Unclamped Inductive Waveforms

Figure 13b.

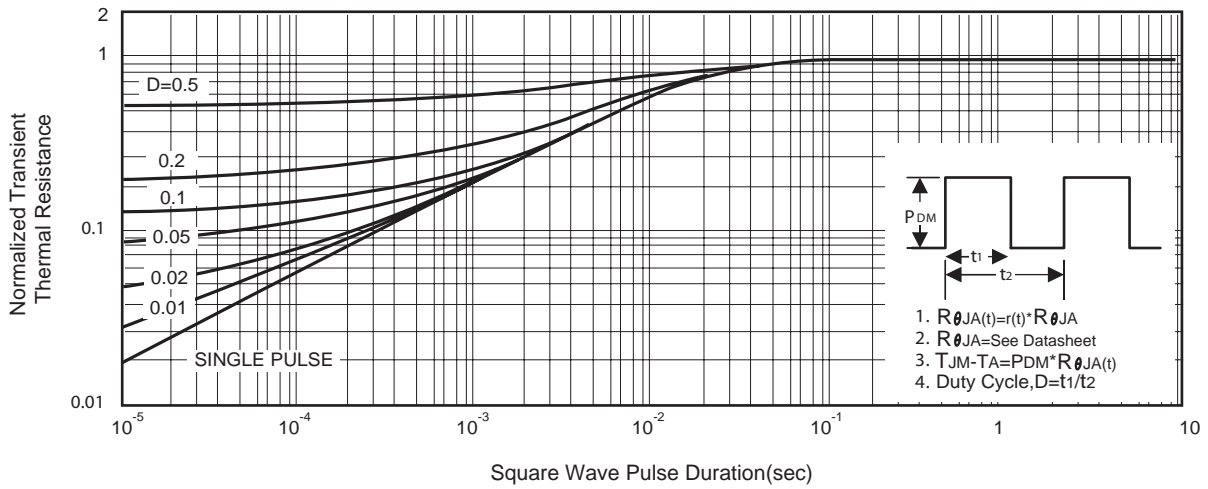
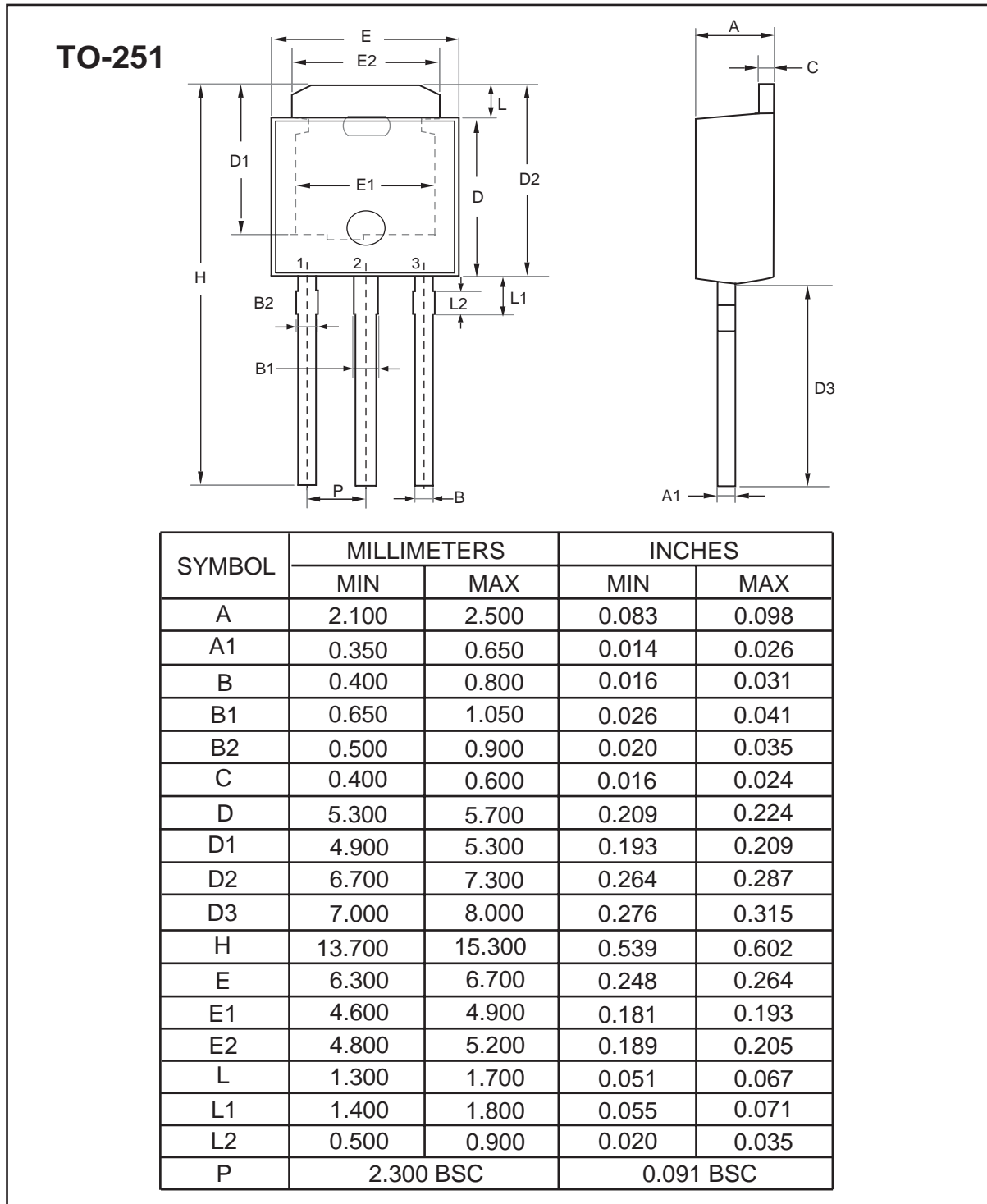

Figure 14. Normalized Thermal Transient Impedance Curve

STU/D16L01

Ver 1.0

PACKAGE OUTLINE DIMENSIONS



Jan,23,2013

STU/D16L01

Ver 1.0

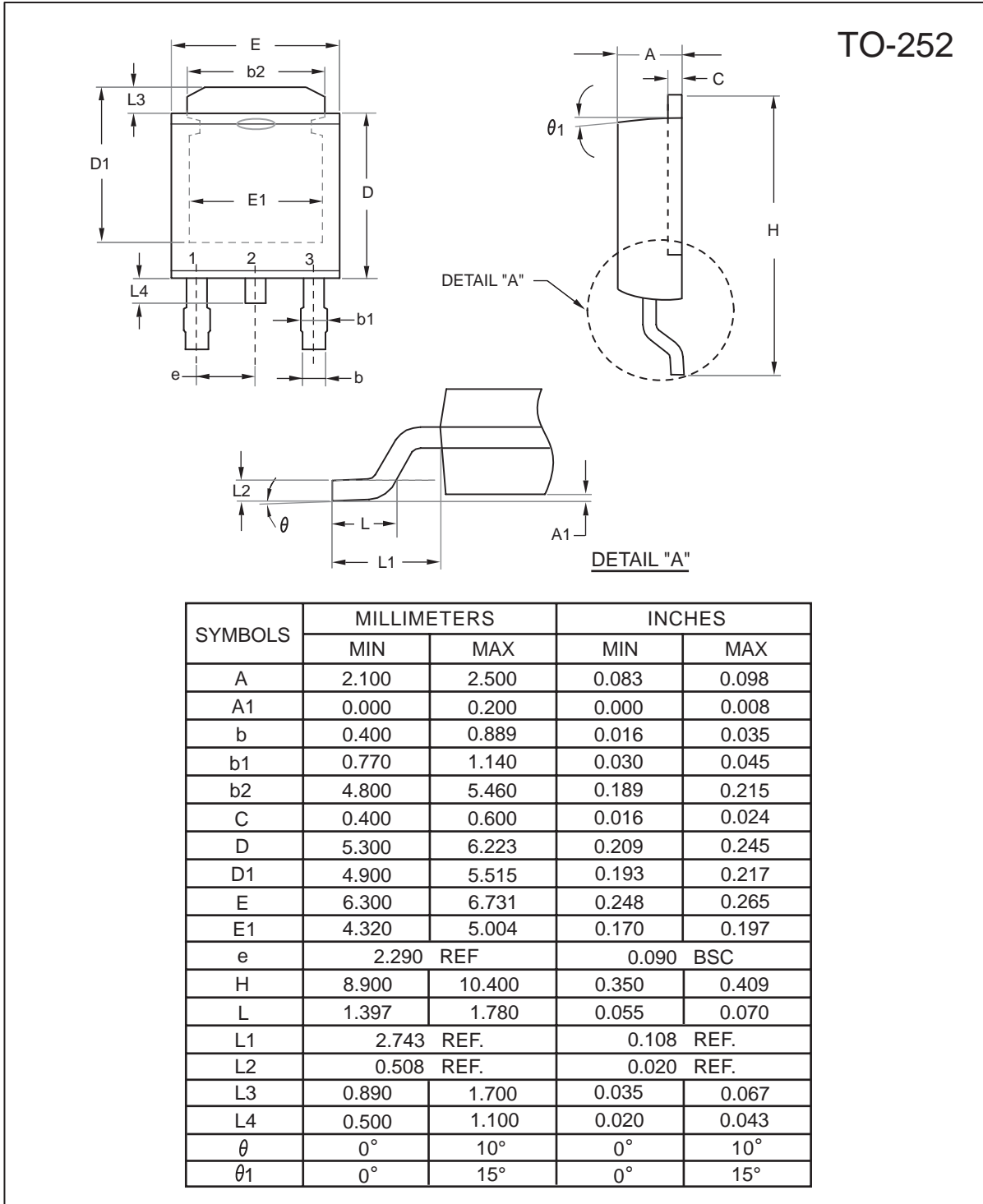

Jan,23,2013

TO-251 Tube/TO-252 Tape and Reel Data

TO-251 Tube

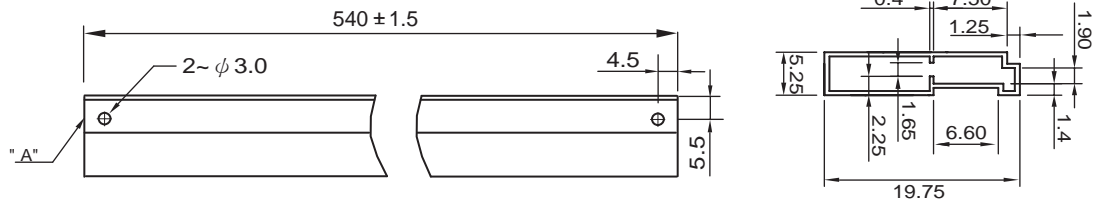

TO-252 Carrier Tape

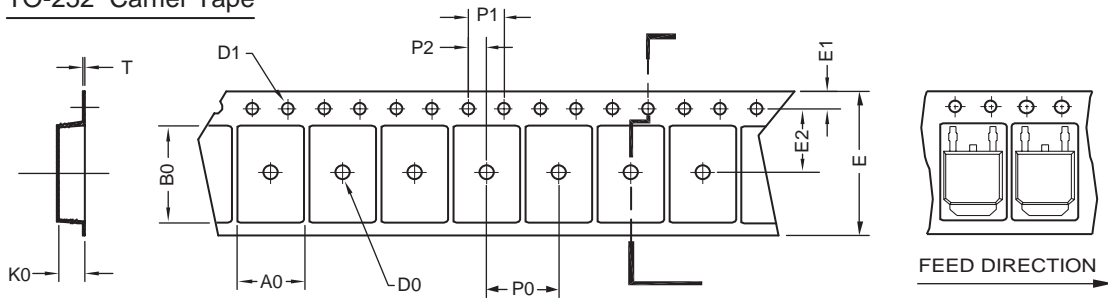

UNIT:mm

PACKAGE	A0	B0	K0	D0	D1	E	E1	E2	P0	P1	P2	T
TO-252 (16 mm)	6.96 ±0.1	10.49 ±0.1	2.79 ±0.1	φ 2	φ 1.5 +0.1 - 0	16.0 ±0.3	1.75 ±0.1	7.5 ±0.15	8.0 ±0.1	4.0 ±0.1	2.0 ±0.15	0.3 ±0.05

TO-252 Reel

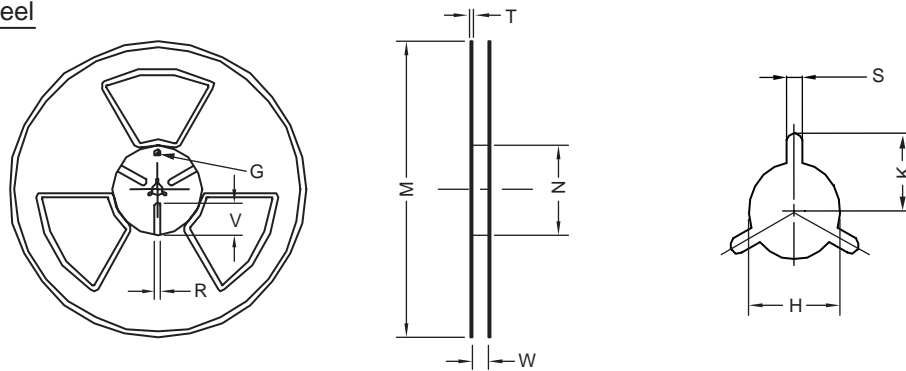

UNIT:mm

TAPE SIZE	REEL SIZE	M	N	W	T	H	K	S	G	R	V
16 mm	φ 330	φ 330 ± 0.5	φ 97 ± 1.0	17.0 + 1.5 - 0	2.2	φ 13.0 + 0.5 - 0.2	10.6	2.0 ±0.5	---	---	---