



N-Channel Enhancement Mode Field Effect Transistor

PRODUCT SUMMARY		
V _{DS}	I _D	R _{DS(ON)} (mΩ) Max
40V	10A	35@ V _{GS} = 10V
		60@ V _{GS} = 4.5V

FEATURES

- Super high dense cell design for low R_{DS(ON)}.
- Rugged and reliable.
- TO-252 and TO-251 Package.

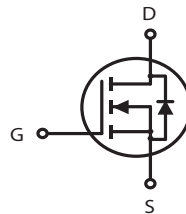

ABSOLUTE MAXIMUM RATINGS (T_A=25°C unless otherwise noted)

Parameter	Symbol	Limit	Unit	
Drain-Source Voltage	V _{DS}	40	V	
Gate-Source Voltage	V _{GS}	±20	V	
Drain Current-Continuous ^a @ T _a	I _D	25°C	10	A
		70°C	8.3	A
-Pulsed ^b	I _{DM}	40	A	
Drain-Source Diode Forward Current ^a	I _S	15	A	
Maximum Power Dissipation ^a	P _D	T _a = 25°C	50	W
		T _a =70°C	35	
Operating Junction and Storage Temperature Range	T _J , T _{STG}	-55 to 175	°C	

THERMAL CHARACTERISTICS

Thermal Resistance, Junction-to-Case	R _{θJC}	3	°C/W
Thermal Resistance, Junction-to-Ambient	R _{θJA}	50	°C/W

STU/D2240NL

N-Channel ELECTRICAL CHARACTERISTICS ($T_A = 25\text{ }^\circ\text{C}$ unless otherwise noted)

Parameter	Symbol	Condition	Min	Typ ^c	Max	Unit
OFF CHARACTERISTICS						
Drain-Source Breakdown Voltage	BV_{DSS}	$V_{GS}=0V, I_D=250\mu A$	40			V
Zero Gate Voltage Drain Current	I_{DSS}	$V_{DS}=32V, V_{GS}=0V$			1	μA
Gate-Body Leakage	I_{GSS}	$V_{GS}=\pm 20V, V_{DS}=0V$			± 100	nA
ON CHARACTERISTICS^b						
Gate Threshold Voltage	$V_{GS(th)}$	$V_{DS}=V_{GS}, I_D=250\mu A$	1.0	1.8	3.0	V
Drain-Source On-State Resistance	$R_{DS(on)}$	$V_{GS}=10V, I_D=10A$		25	35	m ohm
		$V_{GS}=4.5V, I_D=8A$		45	60	m ohm
On-State Drain Current	$I_{D(on)}$	$V_{DS}=5V, V_{GS}=10V$	20			A
Forward Transconductance	g_{FS}	$V_{DS}=10V, I_D=10A$		12		S
DYNAMIC CHARACTERISTICS^c						
Input Capacitance	C_{iss}	$V_{DS}=25V, V_{GS}=0V$ $f=1.0MHz$		840	950	pF
Output Capacitance	C_{oss}			85	98	pF
Reverse Transfer Capacitance	C_{riss}			70	82	pF
Gate resistance	R_g	$V_{GS}=0V, V_{DS}=0V, f=1.0MHz$		2.5		ohm
SWITCHING CHARACTERISTICS^c						
Turn-On Delay Time	$t_{D(on)}$	$V_{DD}=20V$ $I_D=1A$ $V_{GS}=4.5V$ $R_{GEN}=3.3\text{ ohm}$		15.2	18	ns
Rise Time	t_r			4.8	5.6	ns
Turn-Off Delay Time	$t_{D(off)}$			18.6	22	ns
Fall Time	t_f			12.1	14	ns
Total Gate Charge	Q_g	$V_{DS}=20V, I_D=10A, V_{GS}=10V$		18.7	22	nC
		$V_{DS}=20V, I_D=10A, V_{GS}=4.5V$		8.9	10	nC
Gate-Source Charge	Q_{gs}	$V_{DS}=20V, I_D=10A$		3.9	4.6	nC
Gate-Drain Charge	Q_{gd}	$V_{GS}=10V$		3.1	3.6	nC

STU/D2240NL

ELECTRICAL CHARACTERISTICS ($T_c=25^{\circ}\text{C}$ unless otherwise noted)

Parameter	Symbol	Condition	Min	Typ	Max	Unit
DRAIN-SOURCE DIODE CHARACTERISTICS ^a						
Diode Forward Voltage	V_{SD}	$V_{GS} = 0V, I_s = 15A$		1	1.3	V

www.DataSheet4U.com

Notes

- a. Pulse Test: Pulse Width $\leq 300\mu s$, Duty Cycle $\leq 2\%$.
- b. Guaranteed by design, not subject to production testing.

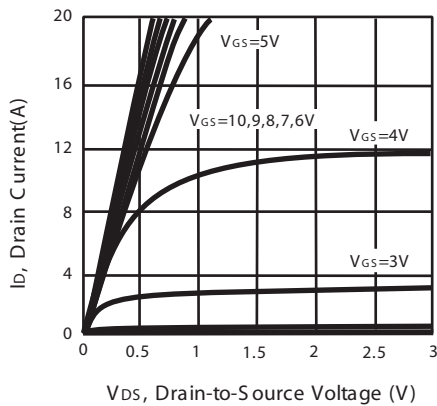

Figure 1. Output Characteristics

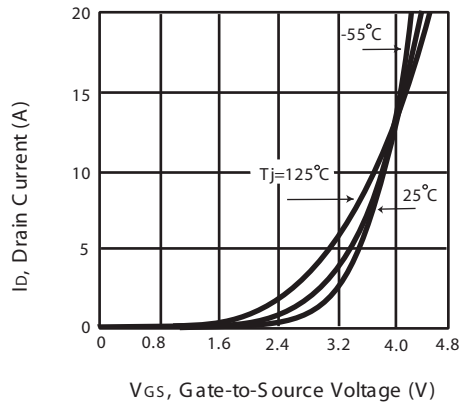

Figure 2. Transfer Characteristics

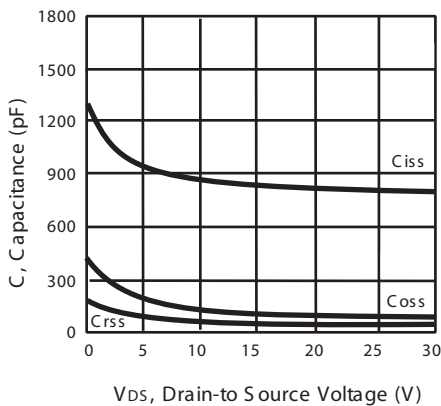

Figure 3. Capacitance

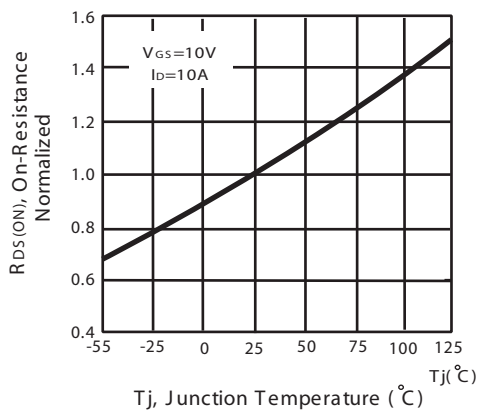

Figure 4. On-Resistance Variation with Drain Current and Temperature

STU/D2240NL

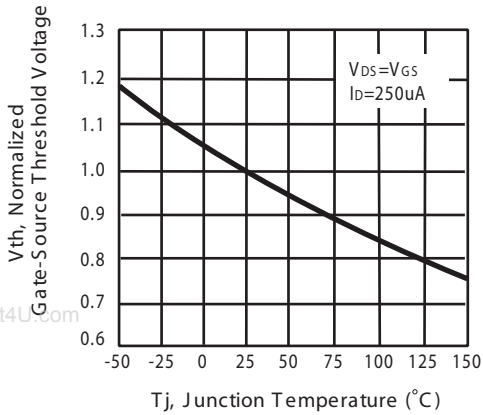

Figure 5. Gate Threshold Variation with Temperature

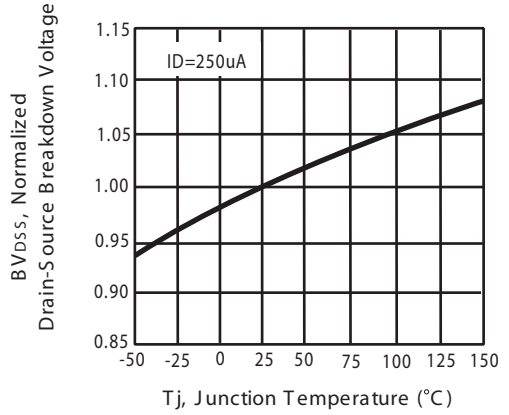

Figure 6. Breakdown Voltage Variation with Temperature

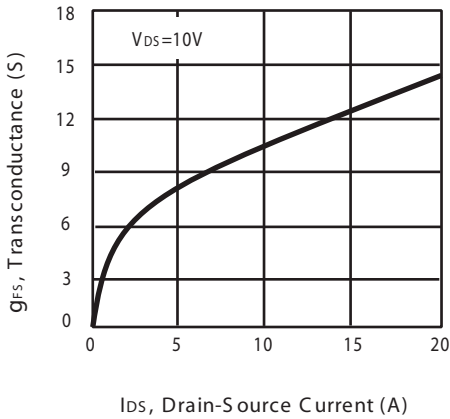

Figure 7. Transconductance Variation with Drain Current

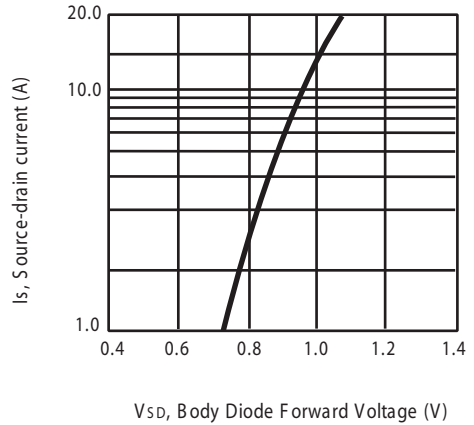

Figure 8. Body Diode Forward Voltage Variation with Source Current

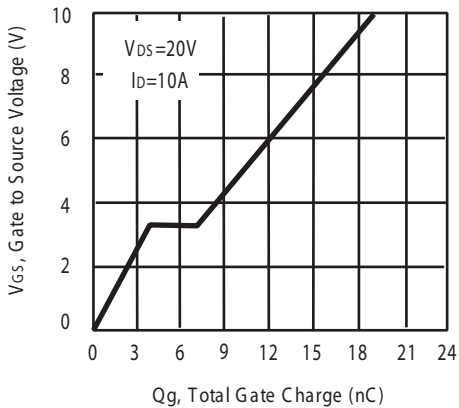

Figure 9. Gate Charge

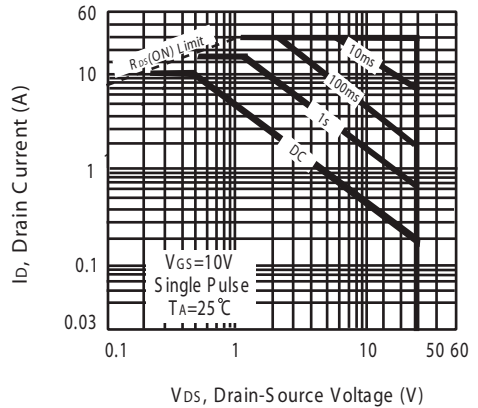

Figure 10. Maximum Safe Operating Area

STU/D2240NL

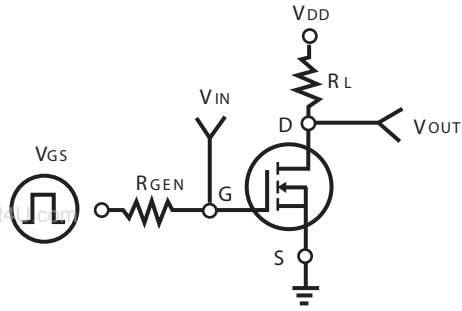

Figure 11. Switching Test Circuit

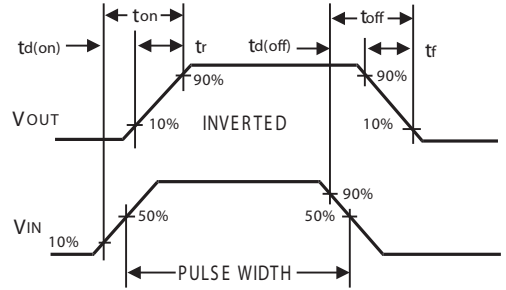
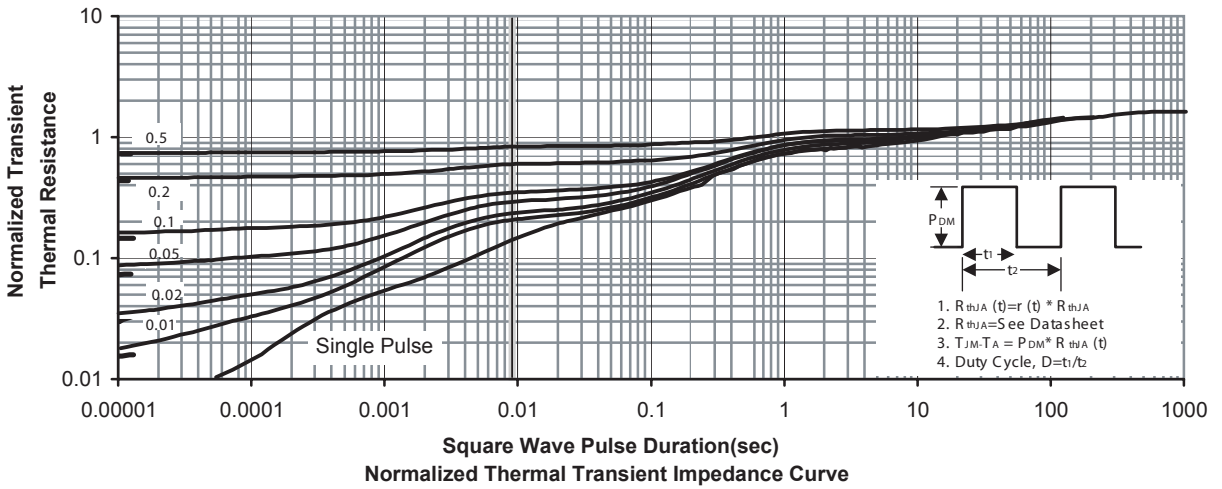

Figure 12. Switching Waveforms



STU/D2240NL

PACKAGE OUTLINE DIMENSIONS

TO-251

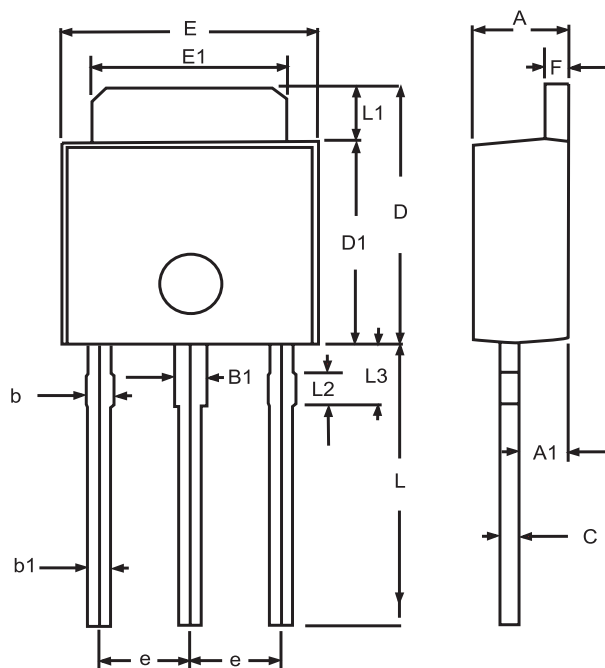

SYMBOLS	MILLIMETERS		INCHES	
	MIN	MAX	MIN	MAX
A	2.20	2.40	0.087	0.095
A1	1.100	1.300	0.043	0.051
B1	0.650	1.050	0.026	0.041
b	0.500	0.900	0.020	0.035
b1	0.400	0.800	0.016	0.32
C	0.400	0.600	0.016	0.024
D	6.700	7.300	0.264	0.287
D1	5.400	5.650	0.213	0.222
E	6.40	6.650	0.252	0.262
e	2.100	2.500	0.083	0.098
F	0.400	0.600	0.016	0.024
L	7.000	8.000	0.276	0.315
L1	1.300	1.700	0.051	0.067
L2	0.700	0.900	0.028	0.035
L3	1.400	1.800	0.055	0.071

STU/D2240NL

PACKAGE OUTLINE DIMENSIONS

TO-252

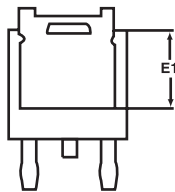
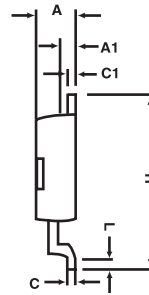
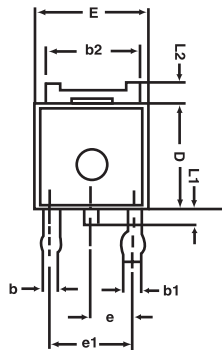

SYMBOLS	MILLIMETERS		INCHES	
	MIN	MAX	MIN	MAX
A	2.25	2.35	0.089	0.093
A1	0.95	1.05	0.037	0.041
b	0.77	0.85	0.030	0.033
b1	0.84	0.94	0.033	0.037
b2	5.30	5.45	0.209	0.215
C	0.49	0.53	0.019	0.021
D	6.00	6.20	0.236	0.244
E	6.40	6.60	0.252	0.260
E1	3.18	3.67	0.125	0.145
e	2.29	BSC	0.090	BSC
H	9.70	10.10	0.382	0.398
L	1.425	1.625	0.056	0.064
L1	0.650	0.850	0.026	0.033
L2	0.600	REF.	0.024	REF.

STU/D2240NL

TO251 Tube/TO-252 Tape and Reel Data

TO-251 Tube



TO-252 Carrier Tape



UNIT:mm

PACKAGE	A0	B0	K0	D0	D1	E	E1	E2	P0	P1	P2	T
TO-252 (16 mm)	6.80 ±0.1	10.3 ±0.1	2.50 ±0.1	φ 2	φ 1.5 + 0.1 - 0	16.0 0.3±	1.75 0.1±	7.5 ±0.15	8.0 ±0.1	4.0 ±0.1	2.0 ±0.15	0.3 ±0.05

TO-252 Reel



UNIT:mm

TAPE SIZE	REEL SIZE	M	N	W	T	H	K	S	G	R	V
16 mm	φ 330	φ 330 ± 0.5	φ 97 ± 1.0	17.0 + 1.5 - 0	2.2	φ 13.0 + 0.5 - 0.2	10.6	2.0 ± 0.5	---	---	---