



STD45NF75

N-channel 75 V, 0.018 Ω , 40 A DPAK
STripFET™ II Power MOSFET

Features

Type	V _{DSS}	R _{DS(on)} max	I _D
STD45NF75	75 V	< 0.024 Ω	40 A ⁽¹⁾

1. Current limited by package

- 100% avalanche tested
- Gate charge minimized

Application

- Switching applications

Description

This Power MOSFET is the latest development of STMicroelectronics's unique "single feature size" strip-based process. The resulting transistor shows extremely high packing density for low on-resistance, rugged avalanche characteristics and less critical alignment steps therefore a remarkable manufacturing reproducibility.

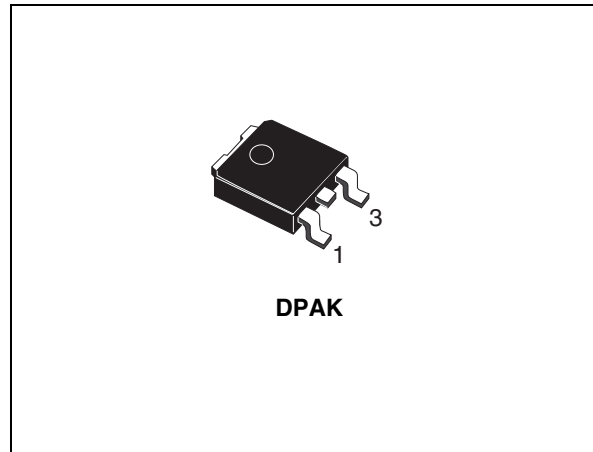

Figure 1. Internal schematic diagram

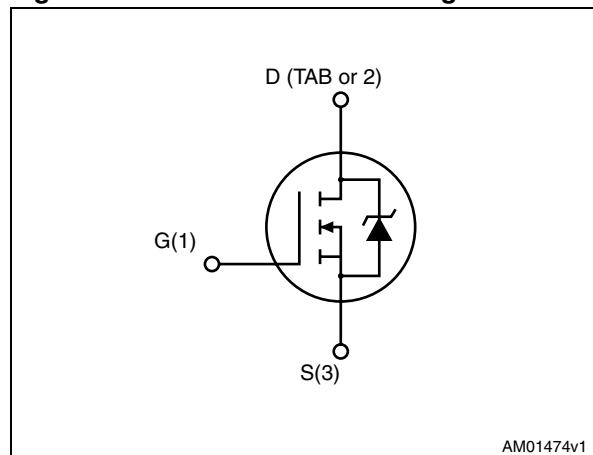

Table 1. Device summary

Order code	Marking	Package	Packaging
STD45NF75T4	D45NF75	DPAK	Tape and reel

Contents

1	Electrical ratings	3
2	Electrical characteristics	4
	2.1 Electrical characteristics (curves)	6
3	Spice thermal model	10
4	Test circuits	11
5	Package mechanical data	12
6	Packing mechanical data	14
7	Revision history	15

1 Electrical ratings

Table 2. Absolute maximum ratings

Symbol	Parameter	Value	Unit
V_{DS}	Drain-source voltage ($V_{GS} = 0$)	75	V
V_{DGR}	Drain-gate voltage ($R_{GS} = 20\text{ k}\Omega$)	75	V
V_{GS}	Gate- source voltage	± 20	V
$I_D^{(1)}$	Drain current (continuous) at $T_C = 25\text{ }^\circ\text{C}$	40	A
I_D	Drain current (continuous) at $T_C = 100\text{ }^\circ\text{C}$	30	A
$I_{DM}^{(2)}$	Drain current (pulsed)	160	A
P_{tot}	Total dissipation at $T_C = 25\text{ }^\circ\text{C}$	125	W
	Derating factor	0.83	W/ $^\circ\text{C}$
$dv/dt^{(3)}$	Peak diode recovery voltage slope	20	V/ns
$E_{AS}^{(4)}$	Single pulse avalanche energy	500	mJ
T_{stg}	Storage temperature	-55 to 175	$^\circ\text{C}$
T_j	Max. operating junction temperature		

1. Current limited by package
2. Pulse width limited by safe operating area.
3. $I_{SD} \leq 40\text{ A}$, $di/dt \leq 800\text{ A}/\mu\text{s}$, $V_{DD} \leq V_{(BR)DSS}$, $T_j \leq T_{JMAX}$
4. Starting $T_j = 25\text{ }^\circ\text{C}$, $I_D = 20\text{ A}$, $V_{DD} = 40\text{ V}$

Table 3. Thermal data

Symbol	Parameter	Value	Unit
$R_{thj-case}$	Thermal resistance junction-case max	1.2	$^\circ\text{C}/\text{W}$
$R_{thj-pcb}$	Thermal resistance junction-pcb max	see Figure 16. and Figure 17.	$^\circ\text{C}/\text{W}$
T_J	Maximum lead temperature for soldering purpose ⁽¹⁾	260	$^\circ\text{C}$

1. for 10 sec. 1.6 mm from case

2 Electrical characteristics

($T_{CASE}=25\text{ °C}$ unless otherwise specified)

Table 4. On/off states

Symbol	Parameter	Test conditions	Min.	Typ.	Max.	Unit
$V_{(BR)DSS}$	Drain-source breakdown voltage	$I_D = 250\ \mu\text{A}$, $V_{GS} = 0$	75			V
I_{DSS}	Zero gate voltage drain current ($V_{GS} = 0$)	$V_{DS} = \text{max rating}$ $V_{DS} = \text{max rating}$, $T_C = 125\text{ °C}$			1 10	μA μA
I_{GSS}	Gate-body leakage current ($V_{DS} = 0$)	$V_{GS} = \pm 20\text{ V}$			± 100	nA
$V_{GS(th)}$	Gate threshold voltage	$V_{DS} = V_{GS}$, $I_D = 250\ \mu\text{A}$	2		4	V
$R_{DS(on)}$	Static drain-source on resistance	$V_{GS} = 10\text{ V}$, $I_D = 20\text{ A}$		0.018	0.024	Ω

Table 5. Dynamic

Symbol	Parameter	Test conditions	Min.	Typ.	Max.	Unit
$g_{fs}^{(1)}$	Forward transconductance	$V_{DS} = 25\text{ V}$, $I_D = 20\text{ A}$	-	50		S
C_{iss} C_{oss} C_{rss}	Input capacitance Output capacitance Reverse transfer capacitance	$V_{DS} = 25\text{ V}$, $f = 1\text{ MHz}$, $V_{GS} = 0$	-	1760 360 140		pF pF pF
$t_{d(on)}$ t_r $t_{d(off)}$ t_f	Turn-on delay time Rise time Turn-off delay time Fall time	$V_{DD} = 37\text{ V}$, $I_D = 20\text{ A}$ $R_G = 4.7\ \Omega$, $V_{GS} = 10\text{ V}$ (see Figure 20)	-	15 40 55 12		ns ns ns ns
Q_g Q_{gs} Q_{gd}	Total gate charge Gate-source charge Gate-drain charge	$V_{DD} = 60\text{ V}$, $I_D = 40\text{ A}$, $V_{GS} = 10\text{ V}$, $R_G = 4.7\ \Omega$ (see Figure 21)	-	60 13 23	80	nC nC nC

1. Pulsed: Pulse duration = 300 μs , duty cycle 1.5%.

Table 6. Source drain diode

Symbol	Parameter	Test conditions	Min.	Typ.	Max.	Unit
I_{SD} $I_{SDM}^{(1)}$	Source-drain current Source-drain current (pulsed)		-		40 160	A A
$V_{SD}^{(2)}$	Forward on voltage	$I_{SD} = 40 \text{ A}$, $V_{GS} = 0$	-		1.5	V
t_{rr} Q_{rr} I_{RRM}	Reverse recovery time Reverse recovery charge Reverse recovery current	$I_{SD} = 40 \text{ A}$, $V_{DD} = 30 \text{ V}$, $di/dt = 100 \text{ A}/\mu\text{s}$, $T_j = 150 \text{ }^\circ\text{C}$ (see Figure 22)	-	120 410 7.5		ns nC A

1. Pulse width limited by safe operating area.
2. Pulsed: Pulse duration = 300 μs , duty cycle 1.5%

2.1 Electrical characteristics (curves)

Figure 2. Safe operating area

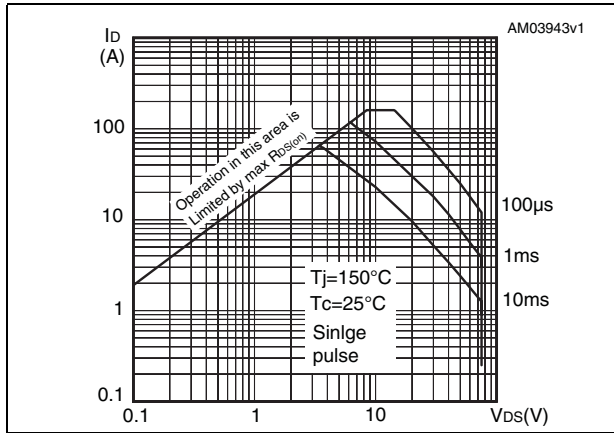

Figure 3. Thermal impedance

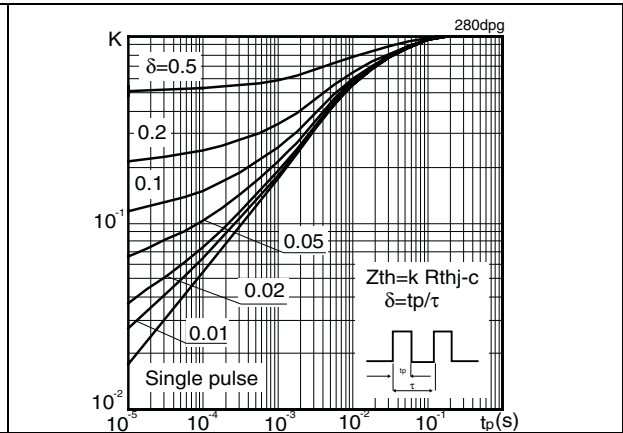

Figure 4. Output characteristics

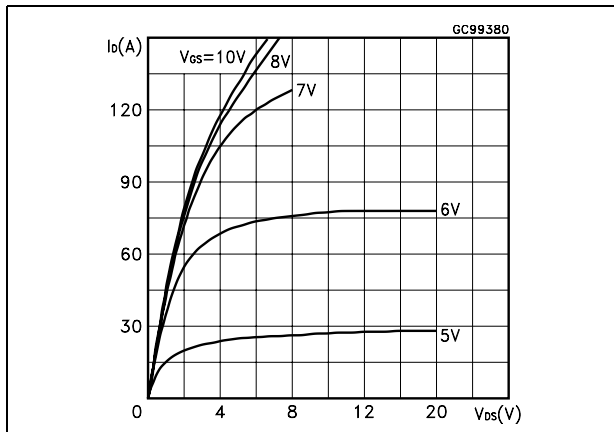

Figure 5. Transfer characteristics

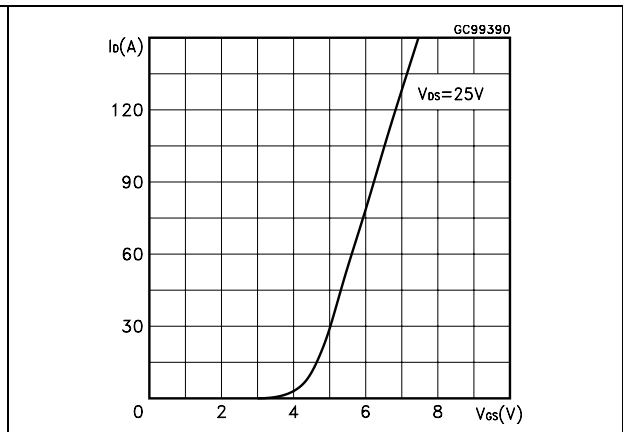

Figure 6. Transconductance

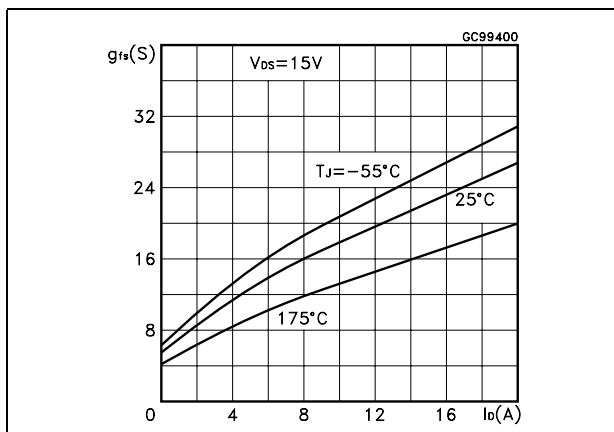

Figure 7. Static drain-source on resistance

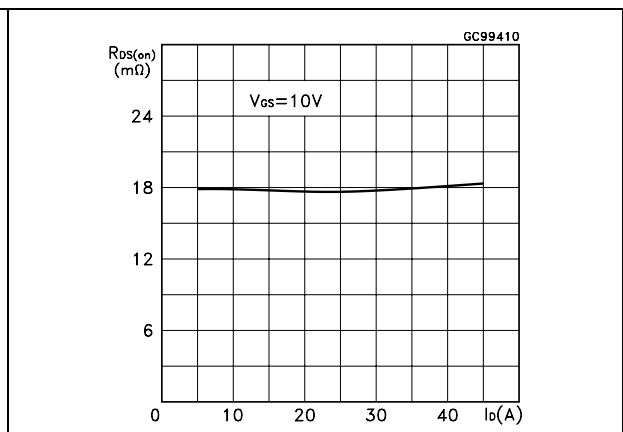

Figure 8. Gate charge vs. gate-source voltage

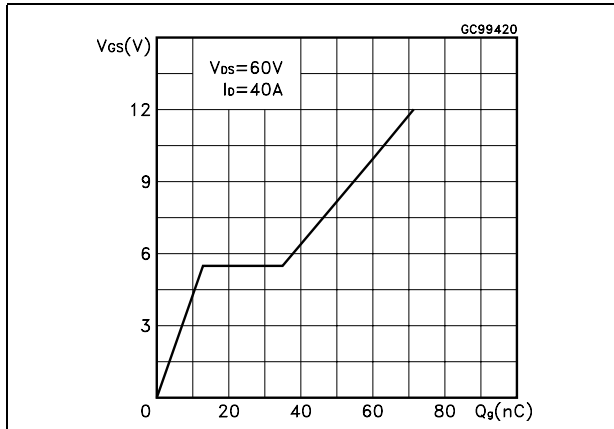

Figure 9. Capacitance variations

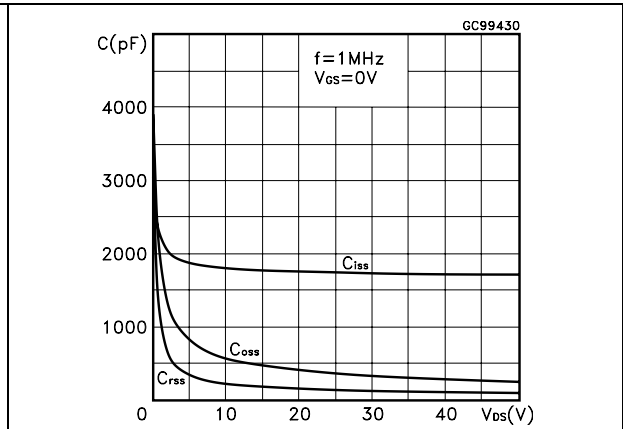

Figure 10. Normalized gate threshold voltage vs. temperature

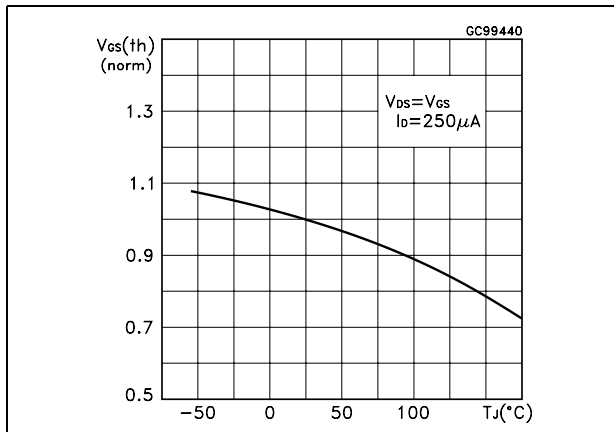

Figure 11. Normalized on resistance vs. temperature

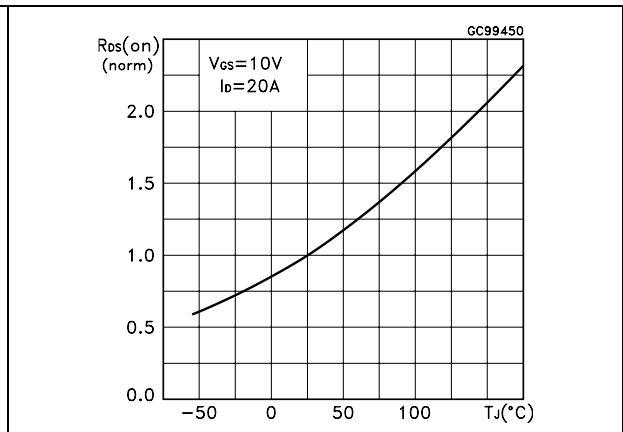

Figure 12. Source-drain diode forward characteristics

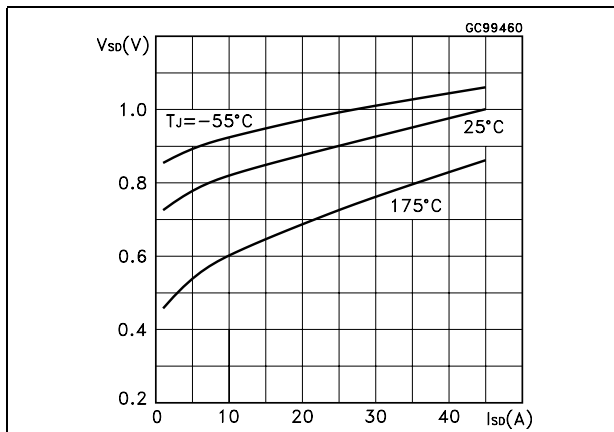

Figure 13. Normalized breakdown voltage vs. temperature

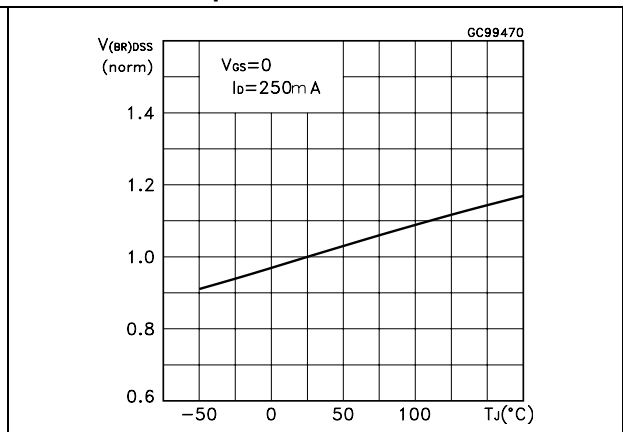

Figure 14. Power derating vs. Tj

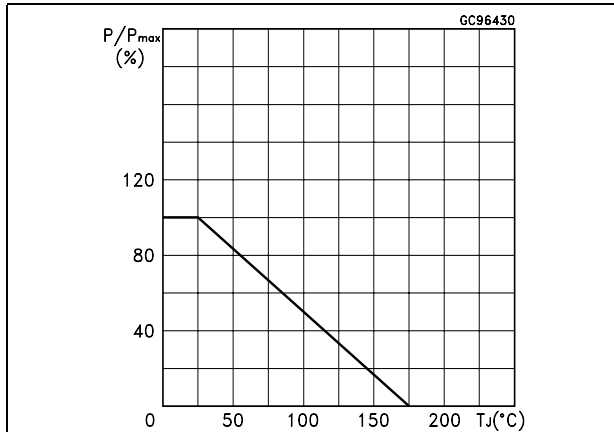

Figure 15. Max Id current vs. Tc

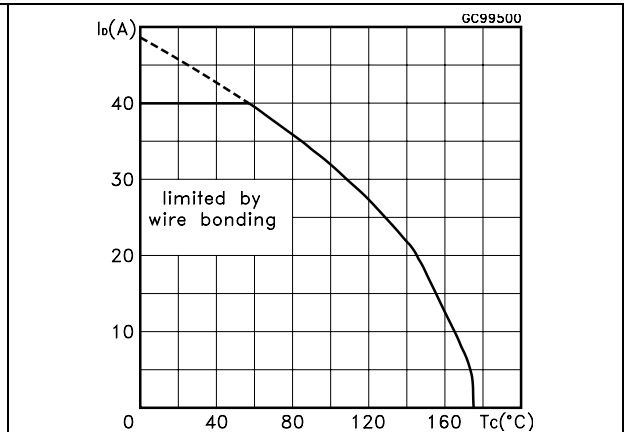

Figure 16. Thermal resistance Rthj-a vs. pcb copper area

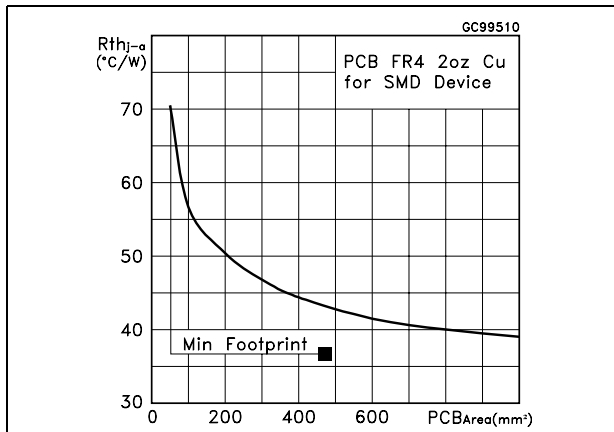

Figure 17. Max power dissipation vs. pcb copper area

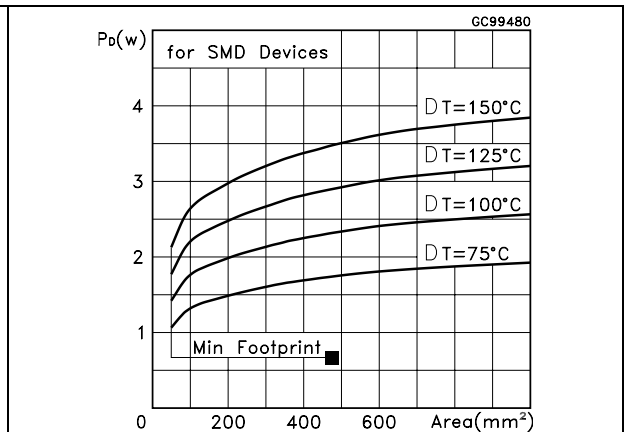
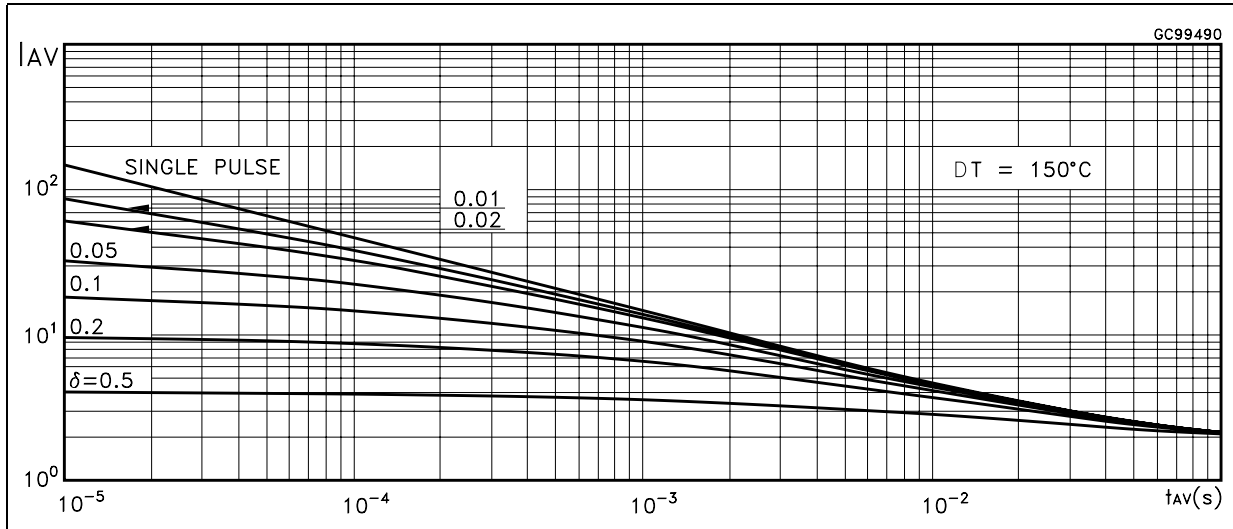

Figure 18. Allowable I_{AV} vs. time in avalanche



The previous curve gives the safe operating area for unclamped inductive loads, single pulse or repetitive, under the following conditions:

$$P_{D(AVE)} = 0.5 * (1.3 * B_{VDSS} * I_{AV})$$

$$E_{AS(AR)} = P_{D(AVE)} * t_{AV}$$

Where:

I_{AV} is the allowable current in avalanche

$P_{D(AVE)}$ is the average power dissipation in avalanche (single pulse)

t_{AV} is the time in avalanche

To de rate above 25°C , at fixed I_{AV} , the following equation must be applied:

$$I_{AV} = 2 * (T_{jmax} - T_{CASE}) / (1.3 * B_{VDSS} * Z_{th})$$

Where:

$Z_{th} = K * R_{th}$ is the value coming from normalized thermal response at fixed pulse width equal to T_{AV} .

3 Spice thermal model

Table 7. Spice parameter

Parameter	Node	Value
CTHERM1	7 - 6	$6 * 10^{-4}$
CTHERM2	6 - 5	$8 * 10^{-3}$
CTHERM3	5 - 4	$2 * 10^{-2}$
CTHERM4	4 - 3	$6 * 10^{-2}$
CTHERM5	3 - 2	$9.65 * 10^{-2}$
CTHERM6	2 - 1	$6 * 10^{-1}$
R THERM1	7 - 6	0.045
R THERM2	6 - 5	0.105
R THERM3	5 - 4	0.150
R THERM4	4 - 3	0.225
R THERM5	3 - 2	0.375
R THERM6	2 - 1	0.600

Figure 19. Thermal network

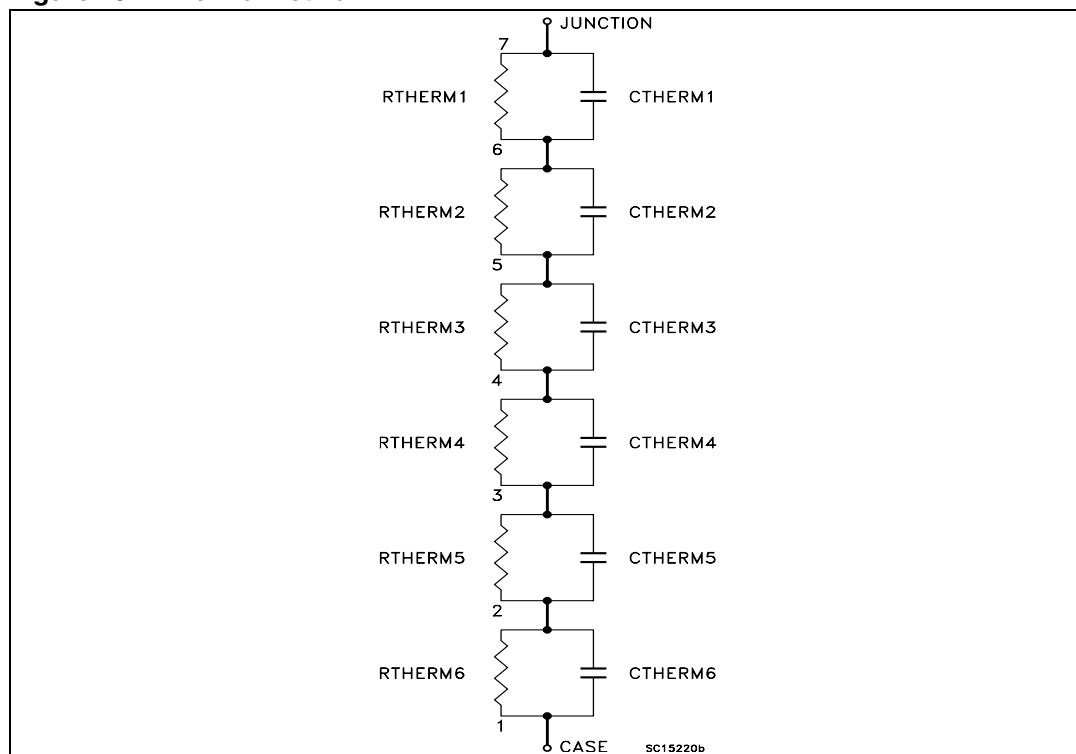

4 Test circuits

Figure 20. Switching times test circuit for resistive load

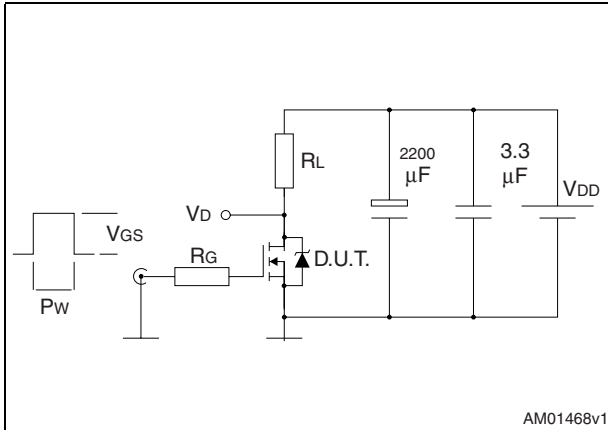

AM01468v1

Figure 21. Gate charge test circuit

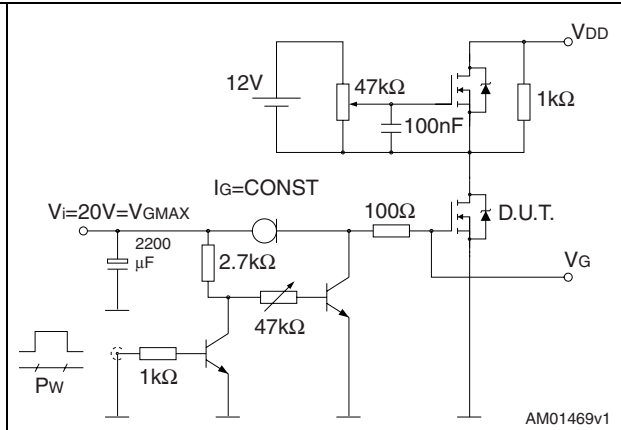

AM01469v1

Figure 22. Test circuit for inductive load switching and diode recovery times

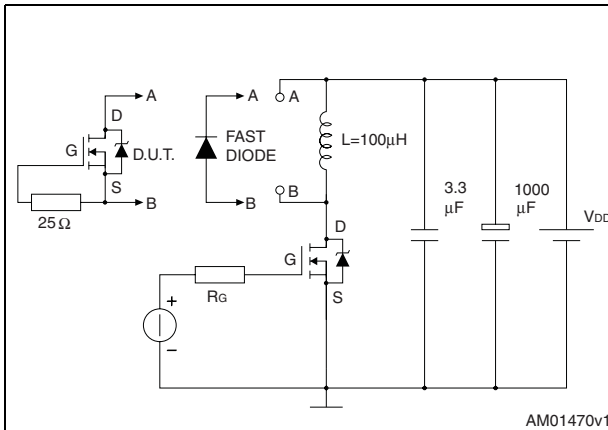

AM01470v1

Figure 23. Unclamped inductive load test circuit

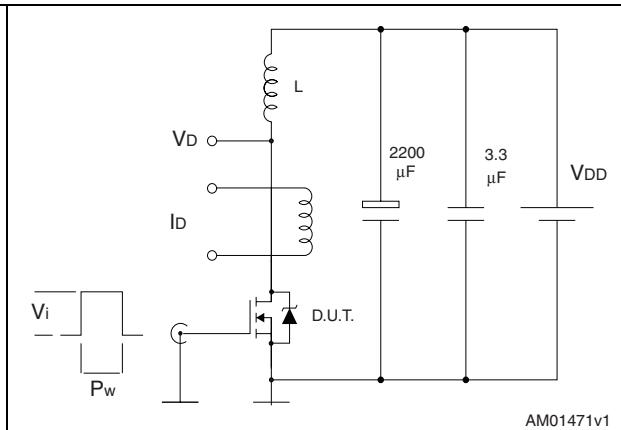

AM01471v1

Figure 24. Unclamped inductive waveform

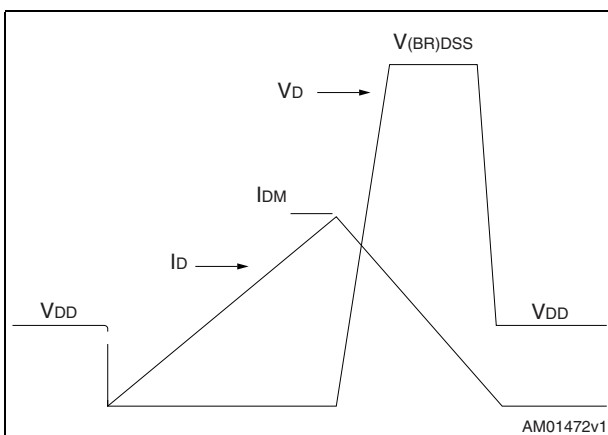

AM01472v1

Figure 25. Switching time waveform

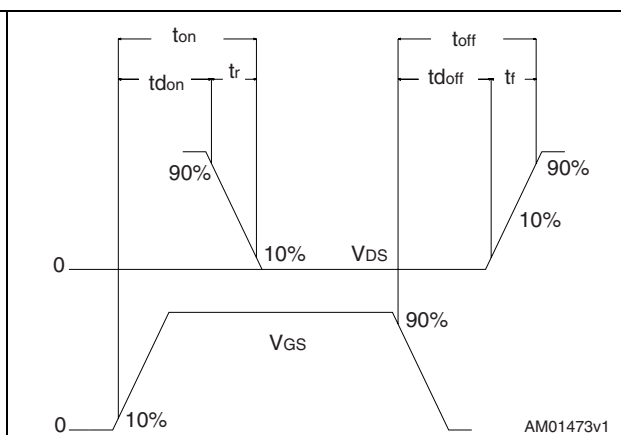

AM01473v1

5 Package mechanical data

In order to meet environmental requirements, ST offers these devices in different grades of ECOPACK[®] packages, depending on their level of environmental compliance. ECOPACK[®] specifications, grade definitions and product status are available at: www.st.com. ECOPACK is an ST trademark.

TO-252 (DPAK) mechanical data

DIM.	mm.		
	min.	typ	max.
A	2.20		2.40
A1	0.90		1.10
A2	0.03		0.23
b	0.64		0.90
b4	5.20		5.40
c	0.45		0.60
c2	0.48		0.60
D	6.00		6.20
D1		5.10	
E	6.40		6.60
E1		4.70	
e		2.28	
e1	4.40		4.60
H	9.35		10.10
L	1		
L1		2.80	
L2		0.80	
L4	0.60		1
R		0.20	
V2	0°		8°

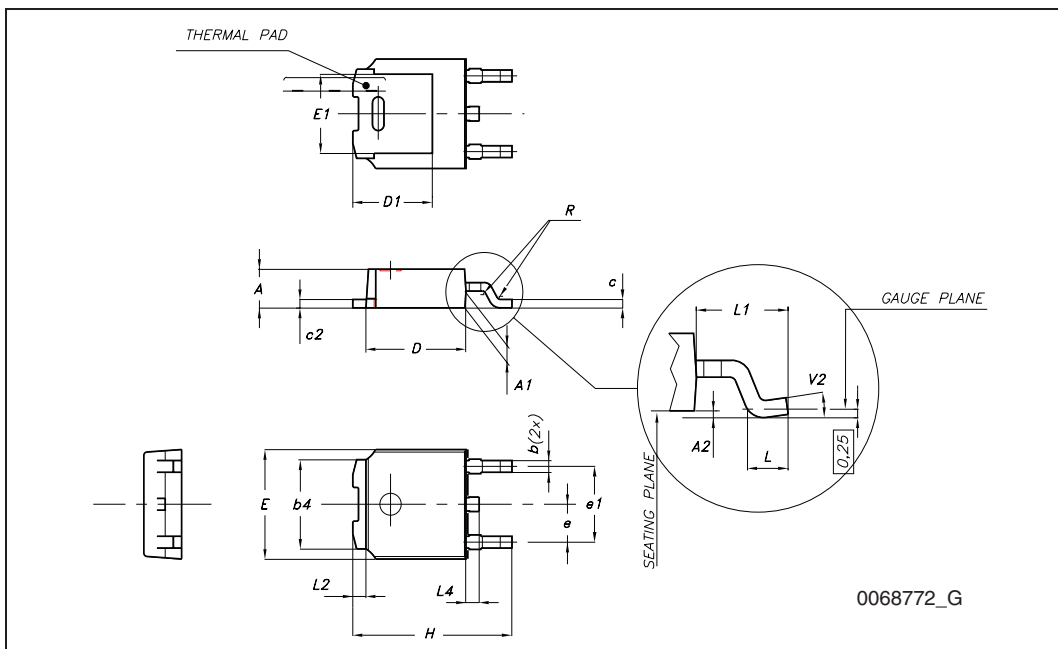

6 Packing mechanical data

DPAK FOOTPRINT

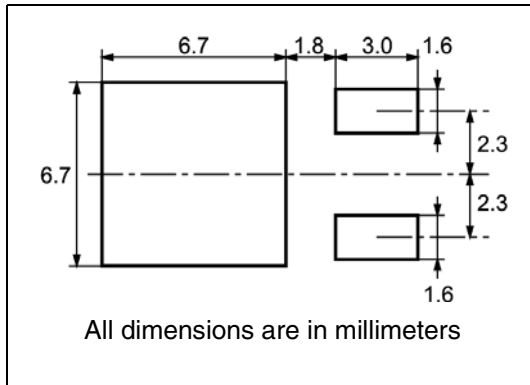

TAPE AND REEL SHIPMENT

40 mm min. Access hole at slot location

Full radius

Tape slot in core for tape start 2.5mm min. width

G measured at hub

REEL MECHANICAL DATA

DIM.	mm		inch	
	MIN.	MAX.	MIN.	MAX.
A		330		12.992
B	1.5		0.059	
C	12.8	13.2	0.504	0.520
D	20.2		0.795	
G	16.4	18.4	0.645	0.724
N	50		1.968	
T		22.4		0.881

TAPE MECHANICAL DATA

DIM.	mm		inch	
	MIN.	MAX.	MIN.	MAX.
A0	6.8	7	0.267	0.275
B0	10.4	10.6	0.409	0.417
B1		12.1		0.476
D	1.5	1.6	0.059	0.063
D1	1.5		0.059	
E	1.65	1.85	0.065	0.073
F	7.4	7.6	0.291	0.299
K0	2.55	2.75	0.100	0.108
P0	3.9	4.1	0.153	0.161
P1	7.9	8.1	0.311	0.319
P2	1.9	2.1	0.075	0.082
R	40		1.574	
W	15.7	16.3	0.618	0.641

TOP COVER TAPE

User Direction of Feed

FEED DIRECTION

Bending radius R min.

7 Revision history

Table 8. Document revision history

Date	Revision	Changes
22-Jun-2004	1	Preliminary version
09-Sep-2004	2	Complete version
11-Jul-2006	3	New template, no content change
20-Feb-2007	4	Typo mistake on page 1
20-May-2009	5	<i>Figure 2</i> and <i>Figure 3</i> have been updated

Please Read Carefully:

Information in this document is provided solely in connection with ST products. STMicroelectronics NV and its subsidiaries ("ST") reserve the right to make changes, corrections, modifications or improvements, to this document, and the products and services described herein at any time, without notice.

All ST products are sold pursuant to ST's terms and conditions of sale.

Purchasers are solely responsible for the choice, selection and use of the ST products and services described herein, and ST assumes no liability whatsoever relating to the choice, selection or use of the ST products and services described herein.

No license, express or implied, by estoppel or otherwise, to any intellectual property rights is granted under this document. If any part of this document refers to any third party products or services it shall not be deemed a license grant by ST for the use of such third party products or services, or any intellectual property contained therein or considered as a warranty covering the use in any manner whatsoever of such third party products or services or any intellectual property contained therein.

UNLESS OTHERWISE SET FORTH IN ST'S TERMS AND CONDITIONS OF SALE ST DISCLAIMS ANY EXPRESS OR IMPLIED WARRANTY WITH RESPECT TO THE USE AND/OR SALE OF ST PRODUCTS INCLUDING WITHOUT LIMITATION IMPLIED WARRANTIES OF MERCHANTABILITY, FITNESS FOR A PARTICULAR PURPOSE (AND THEIR EQUIVALENTS UNDER THE LAWS OF ANY JURISDICTION), OR INFRINGEMENT OF ANY PATENT, COPYRIGHT OR OTHER INTELLECTUAL PROPERTY RIGHT.

UNLESS EXPRESSLY APPROVED IN WRITING BY AN AUTHORIZED ST REPRESENTATIVE, ST PRODUCTS ARE NOT RECOMMENDED, AUTHORIZED OR WARRANTED FOR USE IN MILITARY, AIR CRAFT, SPACE, LIFE SAVING, OR LIFE SUSTAINING APPLICATIONS, NOR IN PRODUCTS OR SYSTEMS WHERE FAILURE OR MALFUNCTION MAY RESULT IN PERSONAL INJURY, DEATH, OR SEVERE PROPERTY OR ENVIRONMENTAL DAMAGE. ST PRODUCTS WHICH ARE NOT SPECIFIED AS "AUTOMOTIVE GRADE" MAY ONLY BE USED IN AUTOMOTIVE APPLICATIONS AT USER'S OWN RISK.

Resale of ST products with provisions different from the statements and/or technical features set forth in this document shall immediately void any warranty granted by ST for the ST product or service described herein and shall not create or extend in any manner whatsoever, any liability of ST.

ST and the ST logo are trademarks or registered trademarks of ST in various countries.

Information in this document supersedes and replaces all information previously supplied.

The ST logo is a registered trademark of STMicroelectronics. All other names are the property of their respective owners.

© 2009 STMicroelectronics - All rights reserved

STMicroelectronics group of companies

Australia - Belgium - Brazil - Canada - China - Czech Republic - Finland - France - Germany - Hong Kong - India - Israel - Italy - Japan - Malaysia - Malta - Morocco - Philippines - Singapore - Spain - Sweden - Switzerland - United Kingdom - United States of America

www.st.com