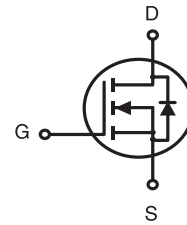

**N-Channel Logic Level Enhancement Mode Field Effect Transistor****PRODUCT SUMMARY**

V <sub>DSS</sub>	I <sub>D</sub>	R <sub>DS(ON)</sub> (mΩ) Max
60V	48A	9.0 @ V <sub>GS</sub> =10V

**FEATURES**

- Super high dense cell design for low R<sub>DS(ON)</sub>.
- Rugged and reliable.
- TO-252 and TO-251 Package.

STU SERIES  
TO-252AA(D-PAK)STD SERIES  
TO-251(I-PAK)**ABSOLUTE MAXIMUM RATINGS (T<sub>C</sub>=25°C unless otherwise noted)**

Symbol	Parameter	Limit	Units
V <sub>DS</sub>	Drain-Source Voltage	60	V
V <sub>GS</sub>	Gate-Source Voltage	±20	V
I <sub>D</sub>	Drain Current-Continuous <sup>c</sup>	T <sub>C</sub> =25°C	48
		T <sub>C</sub> =70°C	38.4
I <sub>DM</sub>	-Pulsed <sup>a c</sup>	140	A
E <sub>AS</sub>	Single Pulse Avalanche Energy <sup>d</sup>	361	mJ
P <sub>D</sub>	Maximum Power Dissipation	T <sub>C</sub> =25°C	42
		T <sub>C</sub> =70°C	27
T <sub>J</sub> , T <sub>STG</sub>	Operating Junction and Storage Temperature Range	-55 to 150	°C

**THERMAL CHARACTERISTICS**

R <sub>θ JC</sub>	Thermal Resistance, Junction-to-Case	3	°C/W
R <sub>θ JA</sub>	Thermal Resistance, Junction-to-Ambient	50	°C/W

# STU607S

## STD607S

Ver 1.0

### ELECTRICAL CHARACTERISTICS (T<sub>c</sub>=25°C unless otherwise noted)

Symbol	Parameter	Conditions	Min	Typ	Max	Units
<b>OFF CHARACTERISTICS</b>						
BV <sub>DSS</sub>	Drain-Source Breakdown Voltage	V <sub>GS</sub> =0V, I <sub>D</sub> =250uA	60			V
I <sub>DSS</sub>	Zero Gate Voltage Drain Current	V <sub>DS</sub> =48V, V <sub>GS</sub> =0V			1	uA
I <sub>GSS</sub>	Gate-Body Leakage Current	V <sub>GS</sub> = ±20V, V <sub>DS</sub> =0V			±100	nA
<b>ON CHARACTERISTICS</b>						
V <sub>GS(th)</sub>	Gate Threshold Voltage	V <sub>DS</sub> =V <sub>GS</sub> , I <sub>D</sub> =250uA	2	3	4	V
R <sub>DS(ON)</sub>	Drain-Source On-State Resistance	V <sub>GS</sub> =10V, I <sub>D</sub> =24A		7.5	9.0	m ohm
g <sub>FS</sub>	Forward Transconductance	V <sub>DS</sub> =10V, I <sub>D</sub> =24A		49		S
<b>DYNAMIC CHARACTERISTICS <sup>b</sup></b>						
C <sub>ISS</sub>	Input Capacitance	V <sub>DS</sub> =25V, V <sub>GS</sub> =0V f=1.0MHz		1670		pF
C <sub>OSS</sub>	Output Capacitance			341		pF
C <sub>RSS</sub>	Reverse Transfer Capacitance			228		pF
<b>SWITCHING CHARACTERISTICS <sup>b</sup></b>						
t <sub>D(ON)</sub>	Turn-On Delay Time	V <sub>DD</sub> =30V I <sub>D</sub> =1A V <sub>GS</sub> =10V R <sub>GEN</sub> = 6 ohm		53		ns
t <sub>r</sub>	Rise Time			75		ns
t <sub>D(OFF)</sub>	Turn-Off Delay Time			46		ns
t <sub>f</sub>	Fall Time			23		ns
Q <sub>g</sub>	Total Gate Charge	V <sub>DS</sub> =30V, I <sub>D</sub> =24A, V <sub>GS</sub> =10V		26		nC
Q <sub>gs</sub>	Gate-Source Charge	V <sub>DS</sub> =30V, I <sub>D</sub> =24A, V <sub>GS</sub> =10V		4		nC
Q <sub>gd</sub>	Gate-Drain Charge			12		nC
<b>DRAIN-SOURCE DIODE CHARACTERISTICS AND MAXIMUM RATINGS</b>						
V <sub>SD</sub>	Diode Forward Voltage	V <sub>GS</sub> =0V, I <sub>S</sub> =8A		0.77	1.3	V

### Notes

- Pulse Test: Pulse Width ≤ 10us, Duty Cycle ≤ 1%.
- Guaranteed by design, not subject to production testing.
- Drain current limited by maximum junction temperature.
- Starting T<sub>J</sub>=25°C, L=0.5mH, V<sub>DD</sub> = 30V. (See Figure13)
- Mounted on FR4 Board of 1 inch<sup>2</sup>, 2oz.

Oct,12,2015

# STU607S STD607S

Ver 1.0

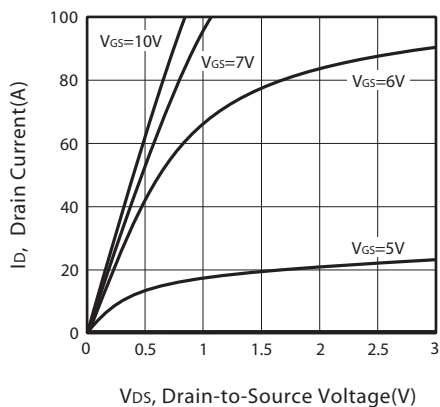

Figure 1. Output Characteristics

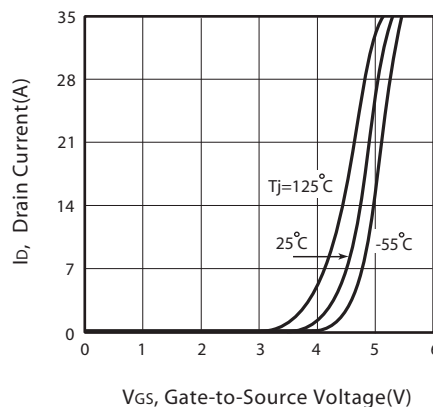

Figure 2. Transfer Characteristics

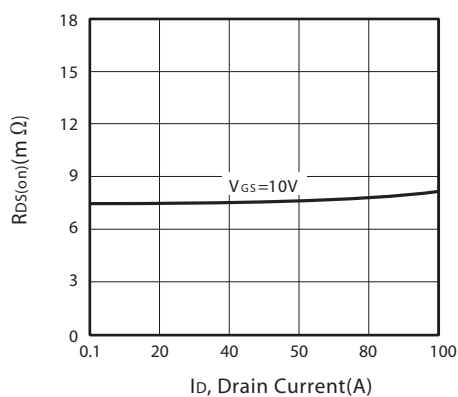

Figure 3. On-Resistance vs. Drain Current and Gate Voltage

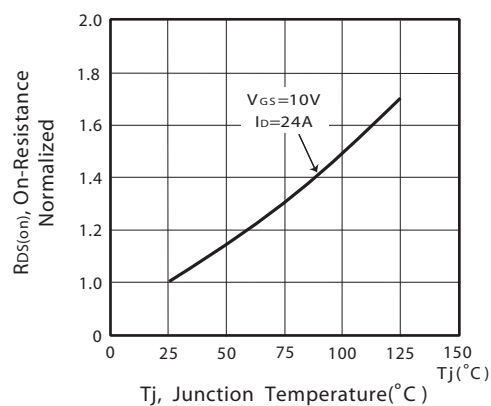

Figure 4. On-Resistance Variation with Drain Current and Temperature

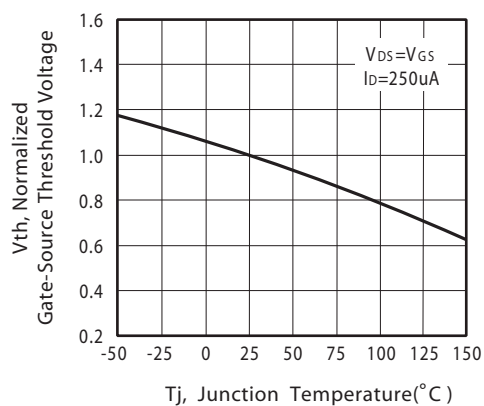

Figure 5. Gate Threshold Variation with Temperature

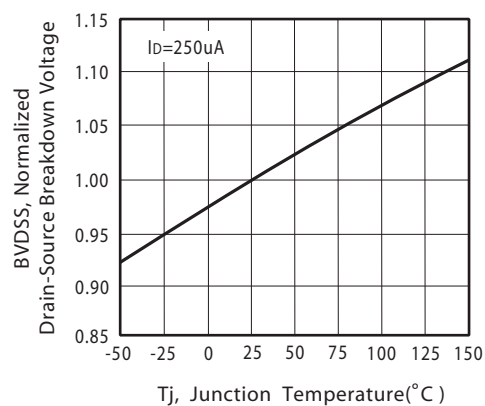

Figure 6. Breakdown Voltage Variation with Temperature

Oct,12,2015

# STU607S STD607S

Ver 1.0

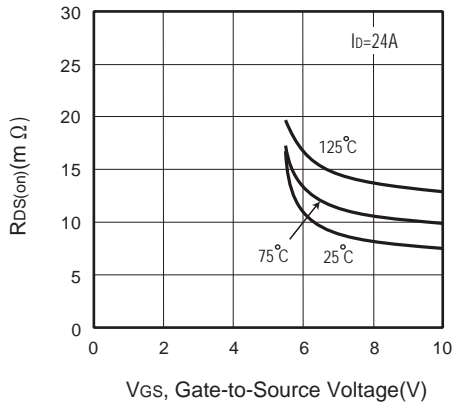

Figure 7. On-Resistance vs. Gate-Source Voltage

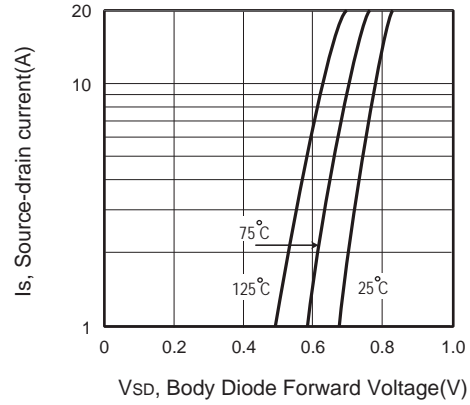

Figure 8. Body Diode Forward Voltage Variation with Source Current

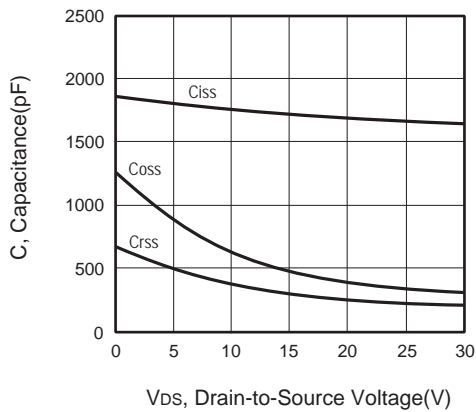

Figure 9. Capacitance

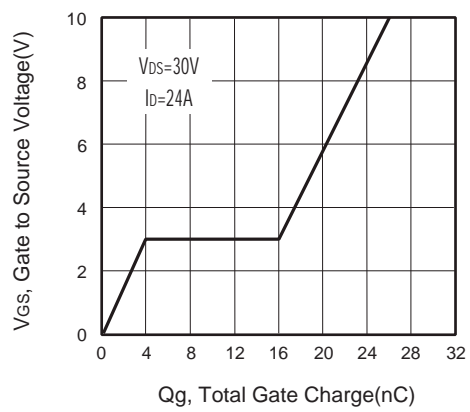

Figure 10. Gate Charge

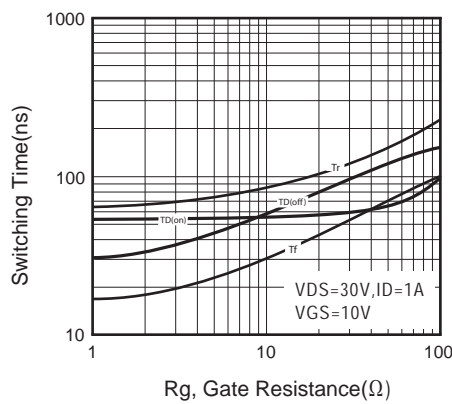

Figure 11. switching characteristics

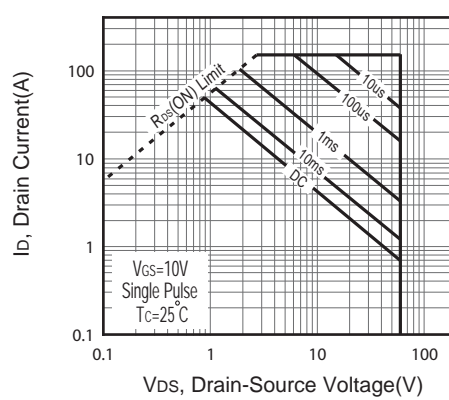
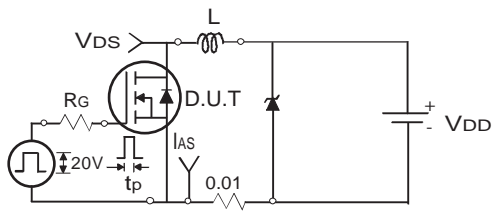

Figure 12. Maximum Safe Operating Area

Oct,12,2015

# STU607S STD607S

Ver 1.0



Uncamped Inductive Test Circuit

Figure 13a.

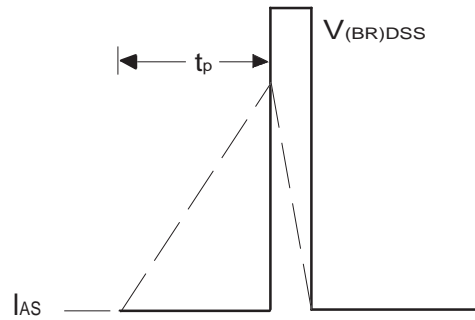

Unclamped Inductive Waveforms

Figure 13b.

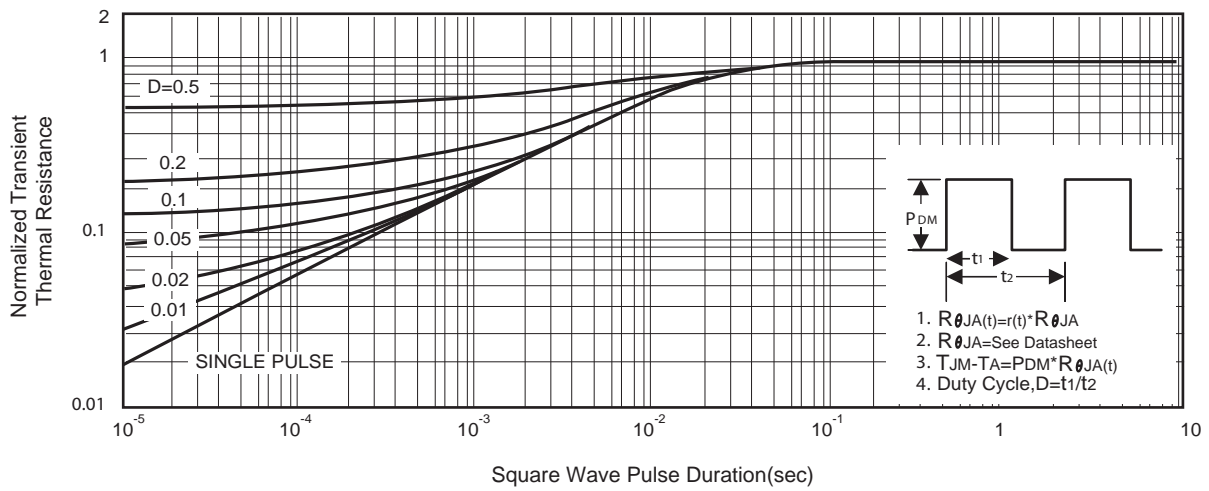

Figure 14. Normalized Thermal Transient Impedance Curve

Oct,12,2015

# STU670S STD670S

Ver 1.0

## TO-252

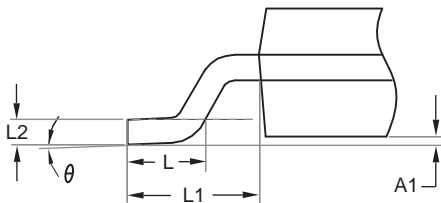
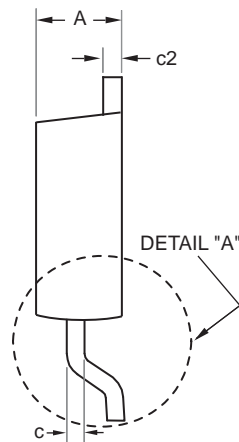
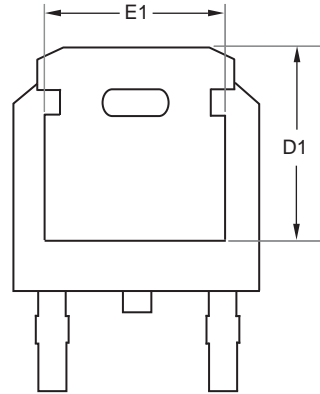
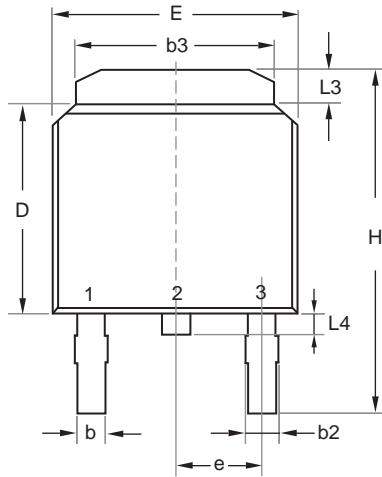

DETAIL "A"

SYMBOLS	MILLIMETERS	
	MIN	MAX
A	2.200	2.380
A1	0.000	0.127
b	0.635	0.889
b2	0.762	1.143
b3	5.200	5.460
c	0.450	0.600
c2	0.450	0.580
D	6.000	6.223
D1	5.210	5.380
e	2.286 BSC	
E	6.400	6.731
E1	4.318	4.900
H	9.400	10.400
L	1.400	1.770
L1	2.743 REF	
L2	0.508 BSC	
L3	0.890	1.270
L4	0.640	1.010
$\theta$	0°	10°

Oct,12,2015

# STU607S STD607S

Ver 1.0

## PACKAGE OUTLINE DIMENSIONS

TO-251

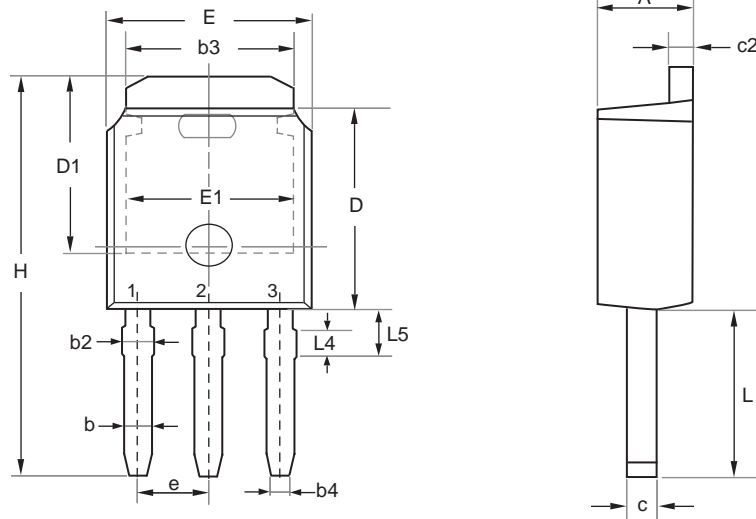

SYMBOL	MILLIMETERS	
	MIN	MAX
E	6.350	6.731
L	3.700	4.400
L4	0.698 REF	
L5	0.972	1.226
D	5.970	6.223
H	9.670	11.450
b	0.630	0.850
b2	0.760	1.140
b3	4.950	5.460
b4	0.450	0.550
e	2.286 BSC	
A	2.180	2.390
c	0.400	0.610
c2	0.400	0.610
D1	5.100	---
E1	4.318	---

Oct,12,2015

# STU607S STD607S

Ver 1.0

## TO-251 Tube/TO-252 Tape and Reel Data

### TO-251 Tube

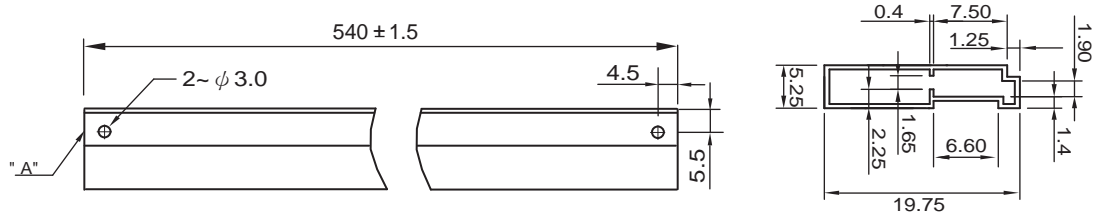

### TO-252 Carrier Tape

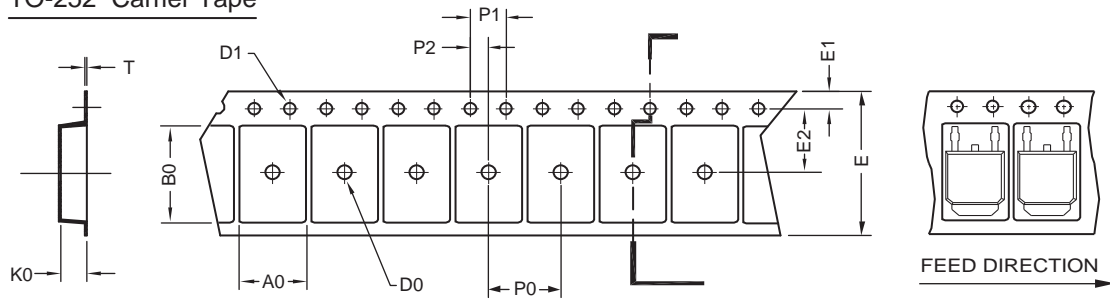

UNIT:mm

PACKAGE	A0	B0	K0	D0	D1	E	E1	E2	P0	P1	P2	T
TO-252 (16 mm)	6.96 ±0.1	10.49 ±0.1	2.79 ±0.1	φ 2	φ 1.5 +0.1 - 0	16.0 ±0.3	1.75 ±0.1	7.5 ±0.15	8.0 ±0.1	4.0 ±0.1	2.0 ±0.15	0.3 ±0.05

### TO-252 Reel

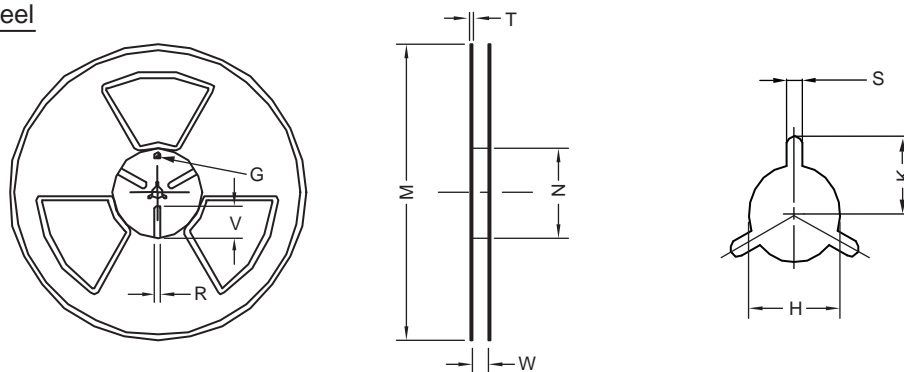

UNIT:mm

TAPE SIZE	REEL SIZE	M	N	W	T	H	K	S	G	R	V
16 mm	φ 330	φ 330 ± 0.5	φ 97 ± 1.0	17.0 + 1.5 - 0	2.2	φ 13.0 + 0.5 - 0.2	10.6	2.0 ±0.5	---	---	---

Oct,12,2015



# STU607S STD607S

Ver 1.0

## TOP MARKING DEFINITION

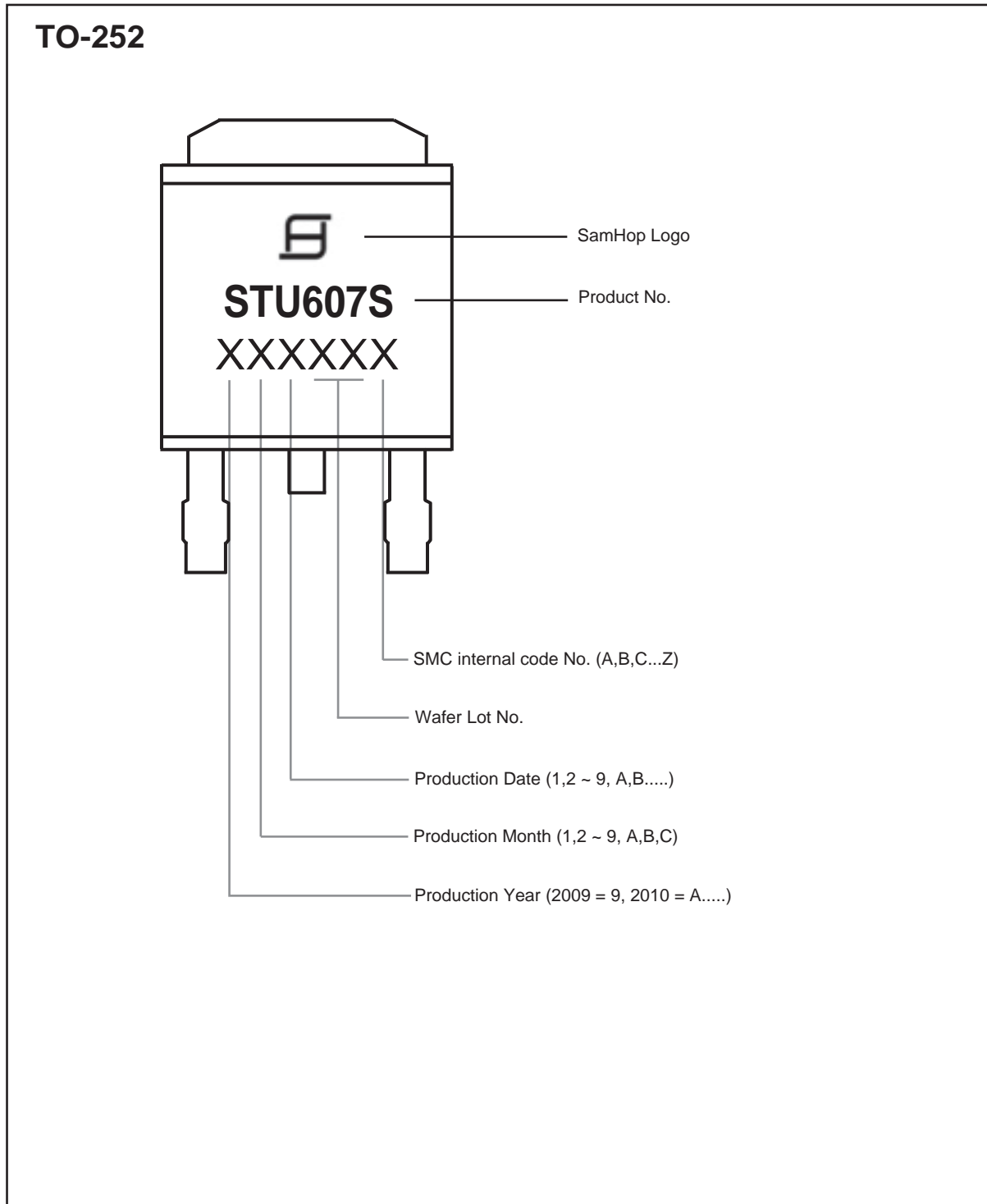

Oct,12,2015

# STU607S STD607S

Ver 1.0

## TOP MARKING DEFINITION

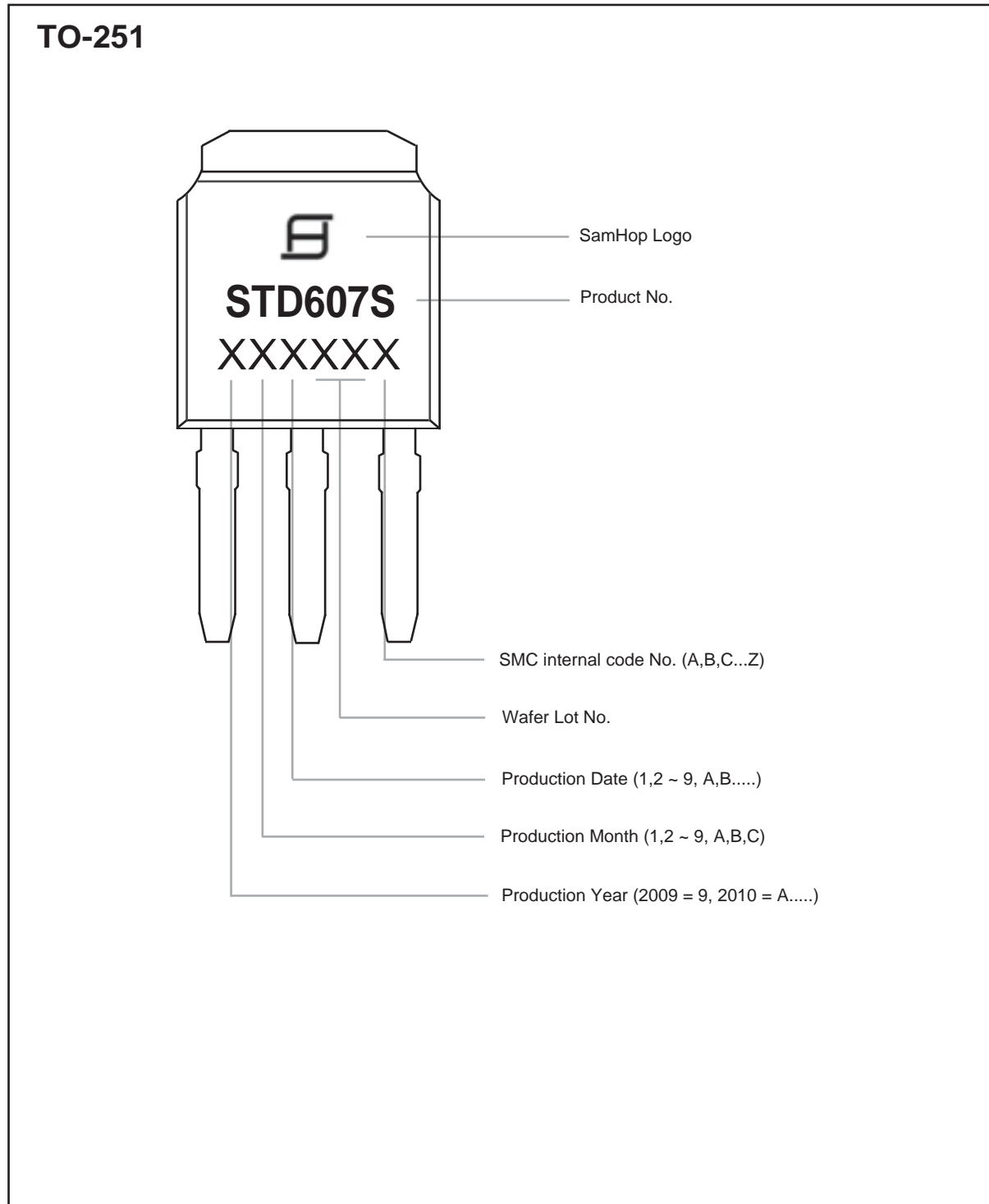

Oct,12,2015