

**N - CHANNEL ENHANCEMENT MODE
POWER MOS TRANSISTOR IN ISOTOP PACKAGE**

TYPE	V _{DSS}	R _{Ds(on)}	I _D
STE15N100	1000 V	< 0.77 Ω	15 A

- HIGH CURRENT POWER MODULE
- AVALANCHE RUGGED TECHNOLOGY (SEE STH6N100 FOR RATING)
- VERY LARGE SOA - LARGE PEAK POWER CAPABILITY
- EASY TO MOUNT
- SAME CURRENT CAPABILITY FOR THE TWO SOURCE TERMINALS
- EXTREMELY LOW R_{th} JUNCTION TO CASE
- VERY LOW DRAIN TO CASE CAPACITANCE
- VERY LOW INTERNAL PARASITIC INDUCTANCE (TYPICALLY < 5 nH)
- ISOLATED PACKAGE UL RECOGNIZED (FILE No E81743)

INDUSTRIAL APPLICATIONS:

- SMPS & UPS
- MOTOR CONTROL
- WELDING EQUIPMENT
- OUTPUT STAGE FOR PWM, ULTRASONIC CIRCUITS

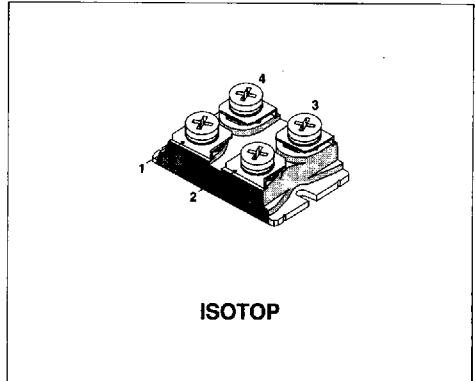

ISOTOP

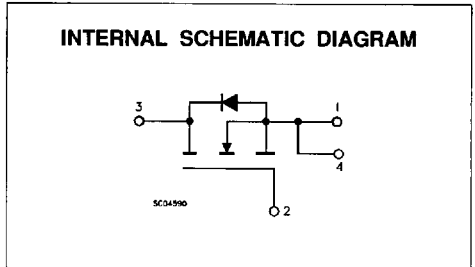

ABSOLUTE MAXIMUM RATINGS

Symbol	Parameter	Value	Unit
V _{DS}	Drain-Source Voltage (V _{GS} = 0)	1000	V
V _{DGR}	Drain-Gate Voltage (R _{GS} = 20 kΩ)	1000	V
V _{GS}	Gate-Source Voltage	± 20	V
I _D	Drain Current (continuous) at T _c = 25 °C	15	A
I _D	Drain Current (continuous) at T _c = 100 °C	9.5	A
I _{DM} (*)	Drain Current (pulsed)	60	A
P _{tot}	Total Dissipation at T _c = 25 °C	400	W
	Derating Factor	3.2	W/°C
T _{stg}	Storage Temperature	-55 to 150	°C
T _J	Max. Operating Junction Temperature	150	°C
V _{ISO}	Insulation Withstand Voltage (AC-RMS)	2500	V

(*) Pulse width limited by safe operating area

THERMAL DATA

$R_{thj-case}$	Thermal Resistance Junction-case	Max	0.31	°C/W
R_{thc-h}	Thermal Resistance Case-heatsink With Conductive Grease Applied	Max	0.05	°C/W

ELECTRICAL CHARACTERISTICS ($T_{case} = 25\text{ }^{\circ}\text{C}$ unless otherwise specified)

OFF

Symbol	Parameter	Test Conditions	Min.	Typ.	Max.	Unit
$V_{(BR)DSS}$	Drain-source Breakdown Voltage	$I_D = 1\text{ mA}$ $V_{GS} = 0\text{ V}$	1000			V
I_{DSS}	Zero Gate Voltage Drain Current ($V_{GS} = 0$)	$V_{DS} = \text{Max Rating}$ $V_{DS} = \text{Max Rating} \times 0.8$ $T_c = 125\text{ }^{\circ}\text{C}$			500 1.5	μA mA
I_{GSS}	Gate-body Leakage Current ($V_{DS} = 0$)	$V_{GS} = \pm 20\text{ V}$			± 300	nA

ON (*)

Symbol	Parameter	Test Conditions	Min.	Typ.	Max.	Unit
$V_{GS(th)}$	Gate Threshold Voltage	$V_{DS} = V_{GS}$ $I_D = 1\text{ mA}$	2		4	V
$R_{DS(on)}$	Static Drain-source On Resistance	$V_{GS} = 10\text{ V}$ $I_D = 9\text{ A}$			0.77	Ω

DYNAMIC

Symbol	Parameter	Test Conditions	Min.	Typ.	Max.	Unit
$g_{fs} (*)$	Forward Transconductance	$V_{DS} = 15\text{ V}$ $I_D = 9\text{ A}$	8			S
C_{iss}	Input Capacitance	$V_{DS} = 25\text{ V}$ $f = 1\text{ MHz}$ $V_{GS} = 0\text{ V}$			7	nF
C_{oss}	Output Capacitance				850	pF
C_{rss}	Reverse Transfer Capacitance				250	pF

SWITCHING ON

Symbol	Parameter	Test Conditions	Min.	Typ.	Max.	Unit
$t_{d(on)}$	Turn-on Time	$V_{DD} = 500\text{ V}$ $I_D = 9\text{ A}$ $R_G = 4.7\text{ }\Omega$ $V_{GS} = 10\text{ V}$ (see test circuit, figure 1)		65		ns
t_r	Rise Time				78	ns
$(di/dt)_{on}$	Turn-on Current Slope	$V_{DD} = 800\text{ V}$ $I_D = 15\text{ A}$ $R_G = 4.7\text{ }\Omega$ $V_{GS} = 10\text{ V}$ (see test circuit, figure 3)		570		A/ μs
Q_g	Total Gate Charge	$V_{DD} = 800\text{ V}$ $I_D = 15\text{ A}$ $V_{GS} = 10\text{ V}$		375		nC

ELECTRICAL CHARACTERISTICS (continued)

SWITCHING OFF

Symbol	Parameter	Test Conditions	Min.	Typ.	Max.	Unit
$t_{r(voff)}$	Off-voltage Rise Time	$V_{DD} = 800\text{ V}$ $I_D = 15\text{ A}$		75	95	ns
t_f	Fall Time	$R_G = 4.7\ \Omega$ $V_{GS} = 10\text{ V}$		18	25	ns
t_c	Cross-over Time	(see test circuit, figure 3)		105	136	ns

SOURCE DRAIN DIODE

Symbol	Parameter	Test Conditions	Min.	Typ.	Max.	Unit
I_{SD}	Source-drain Current				15	A
$I_{SDM}(\bullet)$	Source-drain Current (pulsed)				60	A
$V_{SD}(\ast)$	Forward On Voltage	$I_{SD} = 15\text{ A}$ $V_{GS} = 0$			2.5	V
t_{rr}	Reverse Recovery Time	$I_{SD} = 15\text{ A}$ $di/dt = 100\text{ A}/\mu\text{s}$ $V_{DD} = 100\text{ V}$ $T_J = 150\text{ }^\circ\text{C}$ (see test circuit, figure 3)		1150		ns
Q_{rr}	Reverse Recovery Charge			30		μC
I_{RRM}	Reverse Recovery Current			52		A

(*) Pulsed: Pulse duration = 300 μs , duty cycle 1.5 %

(•) Pulse width limited by safe operating area

Safe Operating Area

Thermal Impedance

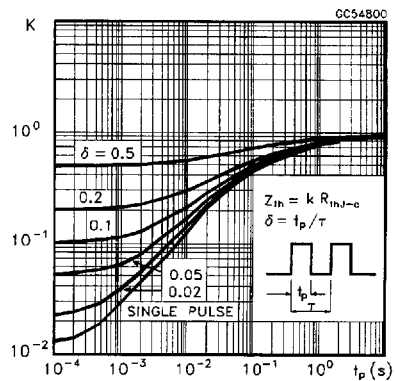
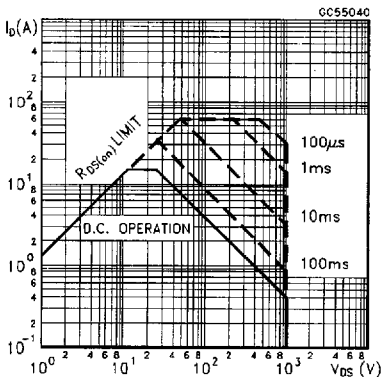

Derating Curve

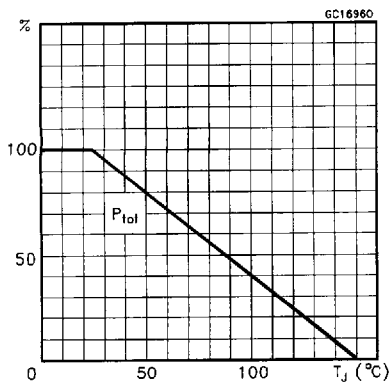

Output Characteristics

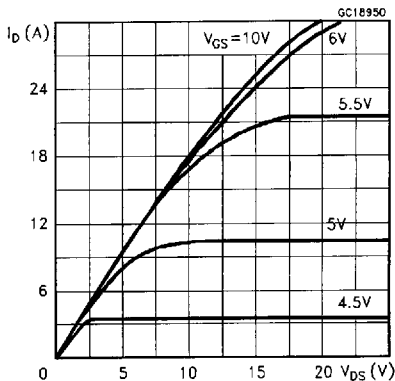

Transfer Characteristics

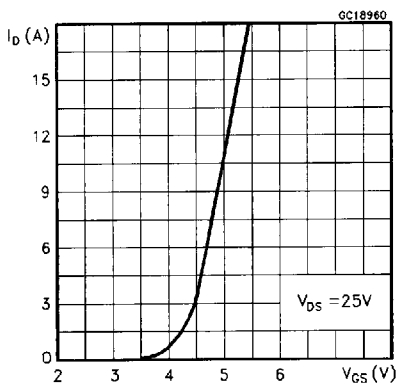

Transconductance

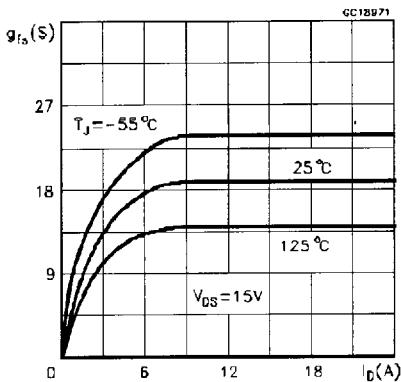

Static Drain-source On Resistance

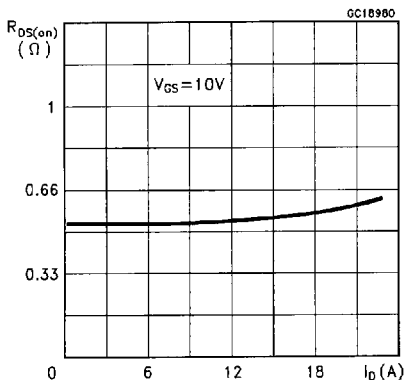

Gate Charge vs Gate-source Voltage

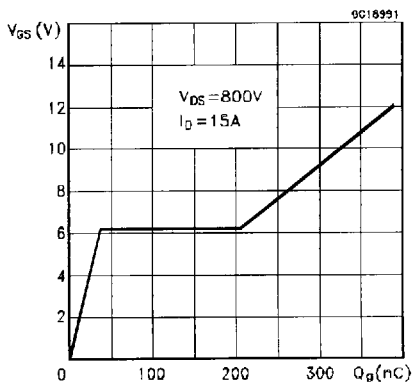

Capacitance Variations

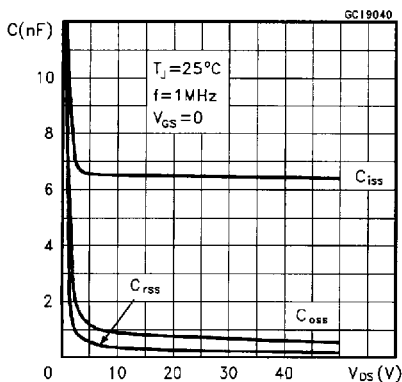

Normalized Gate Threshold Voltage vs Temperature

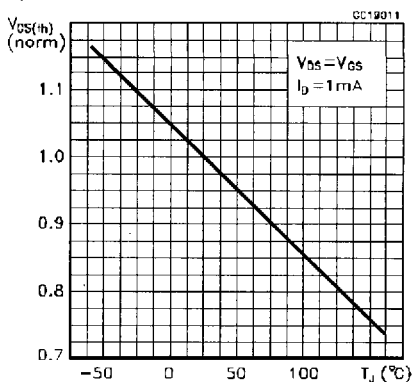

Normalized Breakdown Voltage vs Temperature

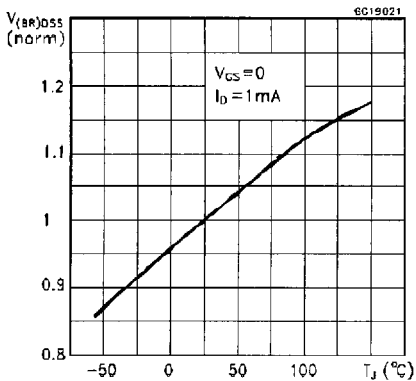

Normalized On Resistance vs Temperature

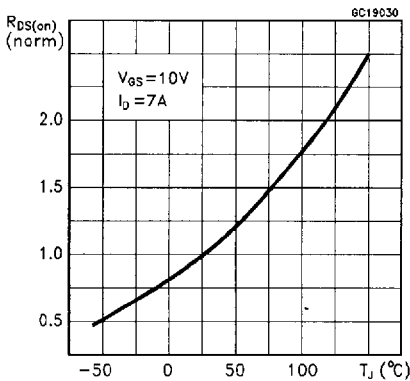

Turn-on Current Slope

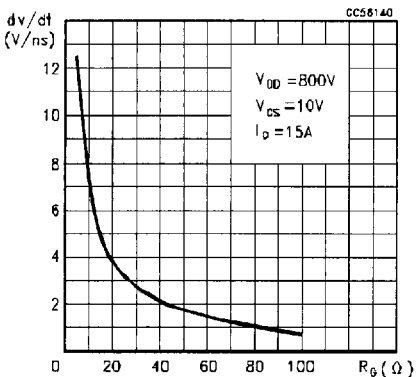

Turn-off Drain-source Voltage Slope

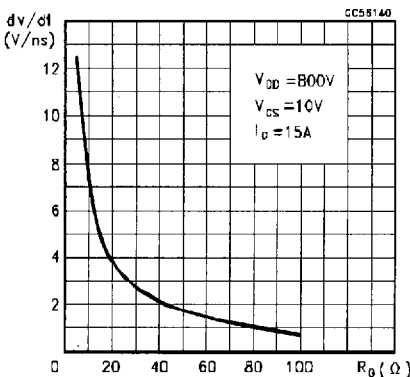

Cross-over Time

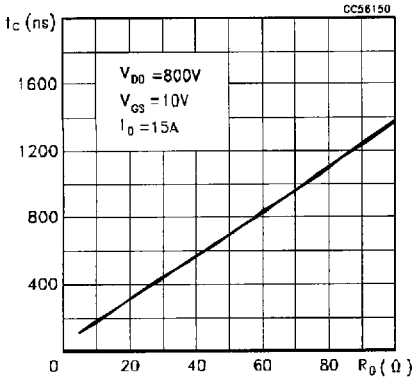
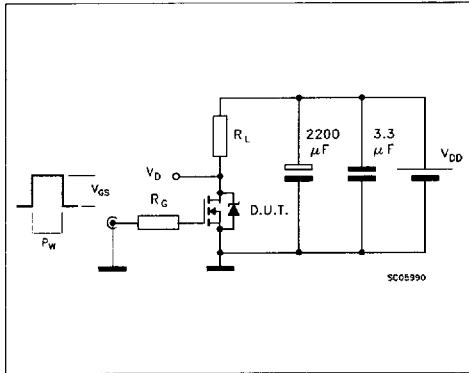

Fig. 1: Switching Times Test Circuits For Resistive Load



Source-drain Diode Forward Characteristics

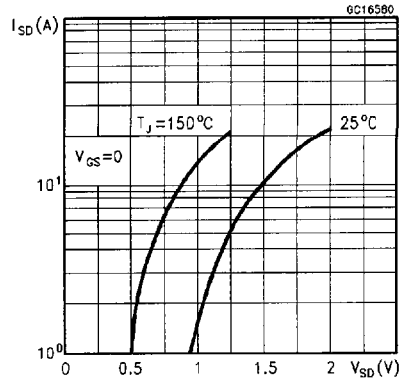

Fig. 2: Gate Charge Test Circuit

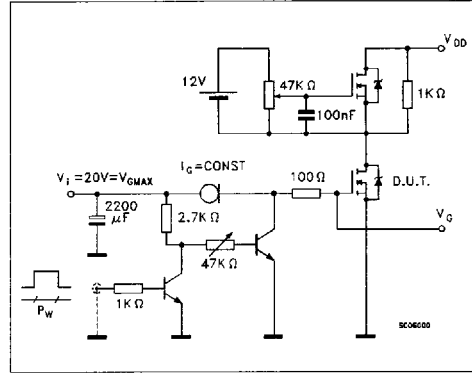

Fig. 3: Test Circuit For Inductive Load Switching And Diode Recovery Times

