

## N - CHANNEL ENHANCEMENT MODE POWER MOS TRANSISTOR IN ISOTOP PACKAGE

TYPE	V <sub>DSS</sub>	R <sub>DS(on)</sub>	I <sub>D</sub>
STE150N10	100 V	< 0.009 Ω	150 A

- HIGH CURRENT POWER MODULE
- AVALANCHE RUGGED TECHNOLOGY (SEE STH60N10 FOR RATING)
- VERY LARGE SOA - LARGE PEAK POWER CAPABILITY
- EASY TO MOUNT
- SAME CURRENT CAPABILITY FOR THE TWO SOURCE TERMINALS
- EXTREMELY LOW R<sub>th</sub> JUNCTION TO CASE
- VERY LOW DRAIN TO CASE CAPACITANCE
- VERY LOW INTERNAL PARASITIC INDUCTANCE (TYPICALLY < 5 nH)
- ISOLATED PACKAGE UL RECOGNIZED (FILE No E81743)

**INDUSTRIAL APPLICATIONS:**

- SMPS & UPS
- MOTOR CONTROL
- WELDING EQUIPMENT
- OUTPUT STAGE FOR PWM, ULTRASONIC CIRCUITS

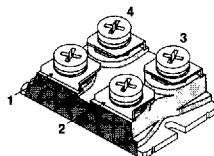
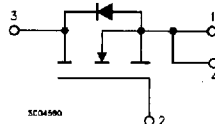
**ISOTOP****INTERNAL SCHEMATIC DIAGRAM****ABSOLUTE MAXIMUM RATINGS**

Symbol	Parameter	Value	Unit
V <sub>DS</sub>	Drain-Source Voltage (V <sub>GS</sub> = 0)	100	V
V <sub>DGR</sub>	Drain-Gate Voltage (R <sub>GS</sub> = 20 kΩ)	100	V
V <sub>GS</sub>	Gate-Source Voltage	± 20	V
I <sub>D</sub>	Drain Current (continuous) at T <sub>c</sub> = 25 °C	150	A
I <sub>D</sub>	Drain Current (continuous) at T <sub>c</sub> = 100 °C	100	A
I <sub>DM</sub> (*)	Drain Current (pulsed)	450	A
P <sub>tot</sub>	Total Dissipation at T <sub>c</sub> = 25 °C	410	W
	Derating Factor	3.3	W/°C
T <sub>stg</sub>	Storage Temperature	-55 to 150	°C
T <sub>j</sub>	Max. Operating Junction Temperature	150	°C
V <sub>ISO</sub>	Insulation Withstand Voltage (AC-RMS)	2500	V

(\*) Pulse width limited by safe operating area

www.DataSheet4U.com

## THERMAL DATA

$R_{thj-case}$	Thermal Resistance Junction-case	Max	0.3	$^{\circ}\text{C/W}$
$R_{thc-h}$	Thermal Resistance Case-heatsink With Conductive Grease Applied	Max	0.05	$^{\circ}\text{C/W}$

ELECTRICAL CHARACTERISTICS ( $T_{case} = 25^{\circ}\text{C}$  unless otherwise specified)

OFF

Symbol	Parameter	Test Conditions	Min.	Typ.	Max.	Unit
$V_{(BR)DSS}$	Drain-source Breakdown Voltage	$I_D = 1\text{ mA}$ $V_{GS} = 0\text{ V}$	100			V
$I_{DSS}$	Zero Gate Voltage Drain Current ( $V_{GS} = 0$ )	$V_{DS} = \text{Max Rating}$ $V_{DS} = \text{Max Rating} \times 0.8$ $T_c = 125^{\circ}\text{C}$			300 1.5	$\mu\text{A}$ mA
$I_{GSS}$	Gate-body Leakage Current ( $V_{DS} = 0$ )	$V_{GS} = \pm 20\text{ V}$			$\pm 300$	nA

ON (\*)

Symbol	Parameter	Test Conditions	Min.	Typ.	Max.	Unit
$V_{GS(th)}$	Gate Threshold Voltage	$V_{DS} = V_{GS}$ $I_D = 1\text{ mA}$	2		4	V
$R_{DS(on)}$	Static Drain-source On Resistance	$V_{GS} = 10\text{ V}$ $I_D = 90\text{ A}$			0.009	$\Omega$

## DYNAMIC

Symbol	Parameter	Test Conditions	Min.	Typ.	Max.	Unit
$g_{fs} (*)$	Forward Transconductance	$V_{DS} = 15\text{ V}$ $I_D = 90\text{ A}$	85			S
$C_{iss}$ $C_{oss}$ $C_{rss}$	Input Capacitance Output Capacitance Reverse Transfer Capacitance	$V_{DS} = 25\text{ V}$ $f = 1\text{ MHz}$ $V_{GS} = 0\text{ V}$			13.5 3600 900	nF pF pF

## SWITCHING ON

Symbol	Parameter	Test Conditions	Min.	Typ.	Max.	Unit
$t_{d(on)}$ $t_r$	Turn-on Time Rise Time	$V_{DD} = 50\text{ V}$ $I_D = 75\text{ A}$ $R_G = 4.7\ \Omega$ $V_{GS} = 10\text{ V}$ (see test circuit, figure 1)		80 140		ns ns
$(di/dt)_{on}$	Turn-on Current Slope	$V_{DD} = 80\text{ V}$ $I_D = 150\text{ A}$ $R_G = 4.7\ \Omega$ $V_{GS} = 10\text{ V}$ (see test circuit, figure 3)		700		A/ $\mu\text{s}$
$Q_g$	Total Gate Charge	$V_{DD} = 80\text{ V}$ $I_D = 150\text{ A}$ $V_{GS} = 10\text{ V}$		320		nC

**ELECTRICAL CHARACTERISTICS** (continued)

**SWITCHING OFF**

Symbol	Parameter	Test Conditions	Min.	Typ.	Max.	Unit
$t_{r(VoH)}$	Off-voltage Rise Time	$V_{DD} = 80\text{ V}$ $I_D = 150\text{ A}$		90		ns
$t_f$	Fall Time	$R_G = 4.7\ \Omega$ $V_{GS} = 10\text{ V}$		340		ns
$t_c$	Cross-over Time	(see test circuit, figure 3)		400		ns

**SOURCE DRAIN DIODE**

Symbol	Parameter	Test Conditions	Min.	Typ.	Max.	Unit
$I_{SD}$	Source-drain Current				150	A
$I_{SDM}(\ast)$	Source-drain Current (pulsed)				450	A
$V_{SD}(\ast)$	Forward On Voltage	$I_{SD} = 150\text{ A}$ $V_{GS} = 0$			1.6	V
$t_{rr}$	Reverse Recovery Time	$I_{SD} = 150\text{ A}$ $di/dt = 100\text{ A}/\mu\text{s}$ $V_{DD} = 50\text{ V}$ $T_J = 150\text{ }^\circ\text{C}$ (see test circuit, figure 3)		230		ns
$Q_{rr}$	Reverse Recovery Charge			1750		$\mu\text{C}$
$I_{RRM}$	Reverse Recovery Current			15		A

(\*) Pulsed: Pulse duration = 300  $\mu\text{s}$ , duty cycle 1.5 %

(\*) Pulse width limited by safe operating area

**Safe Operating Area**

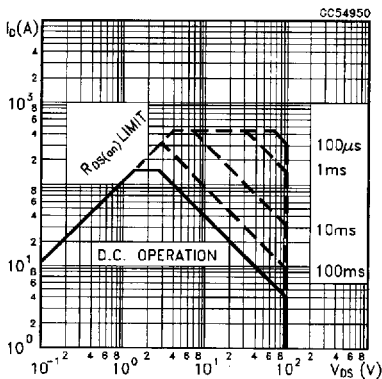

**Thermal Impedance**

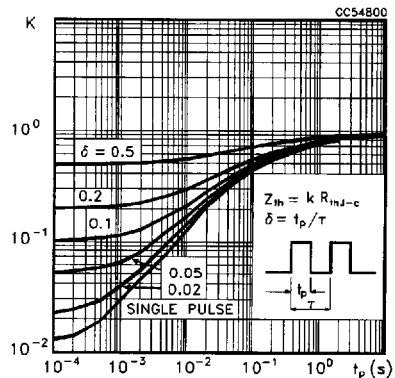

Derating Curve

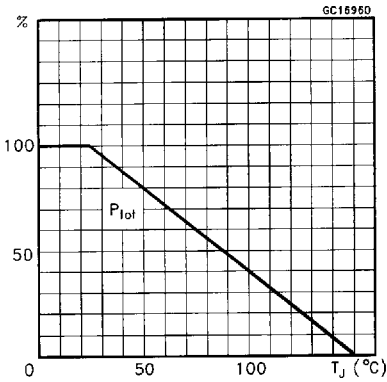

Output Characteristics

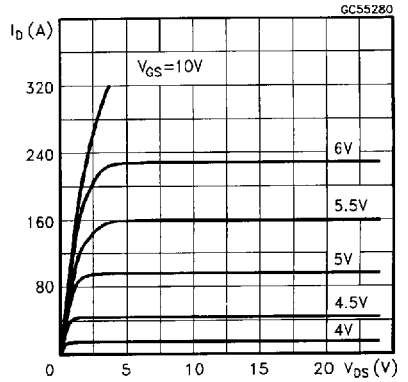

Transfer Characteristics

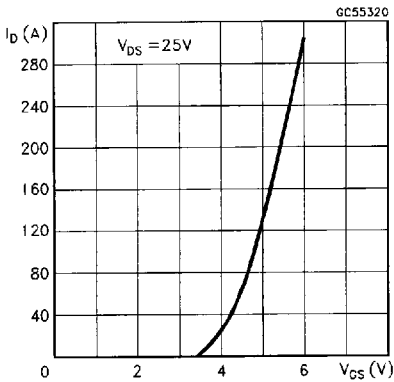

Transconductance

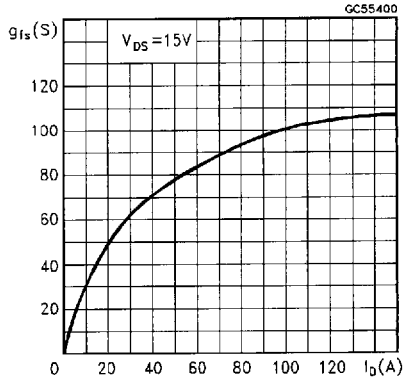

Static Drain-source On Resistance

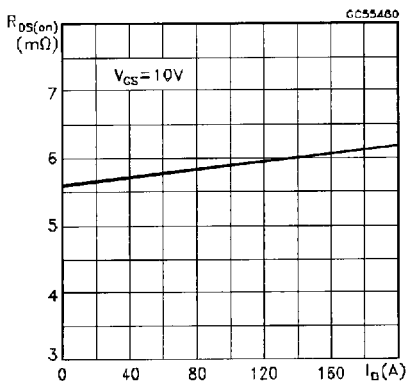

Gate Charge vs Gate-source Voltage

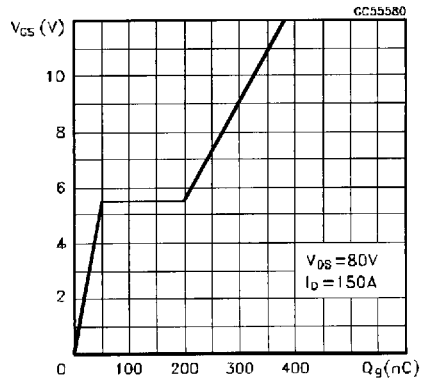

Capacitance Variations

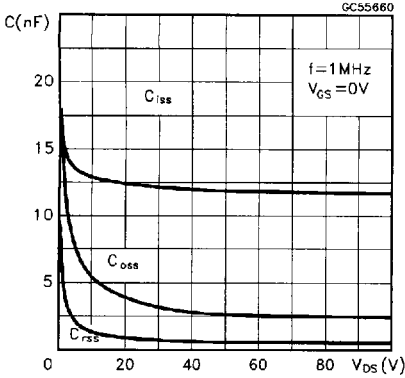

Normalized Gate Threshold Voltage vs Temperature

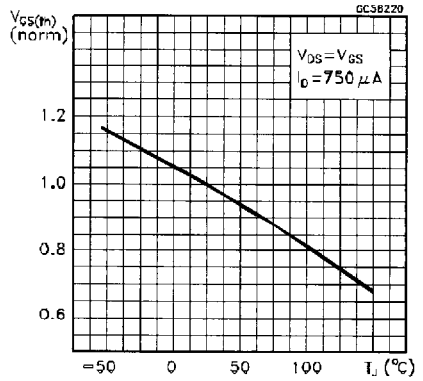

Normalized Breakdown Voltage vs Temperature

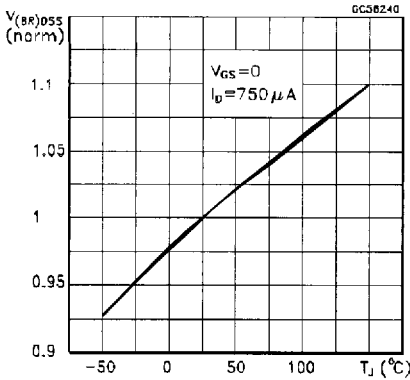

Normalized On Resistance vs Temperature

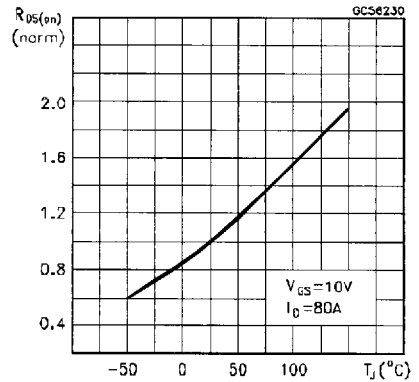

Turn-on Current Slope

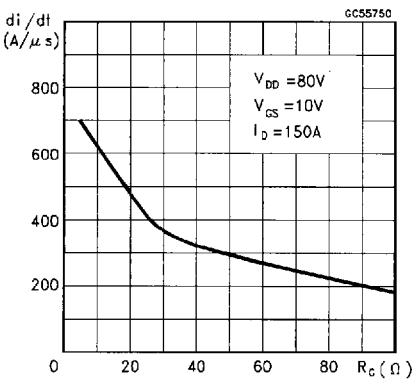

Turn-off Drain-source Voltage Slope

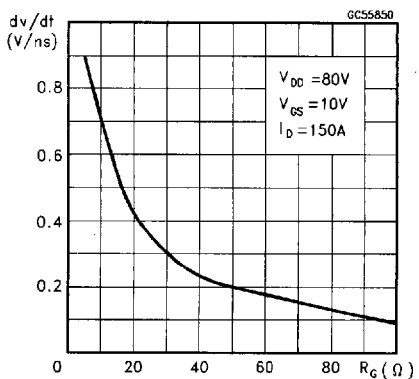

Cross-over Time

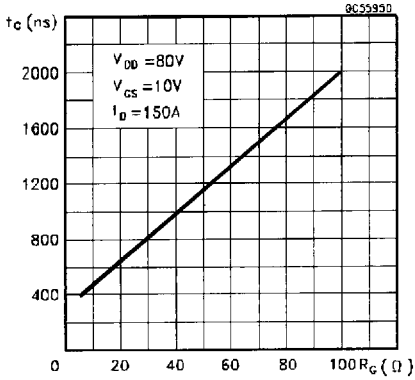
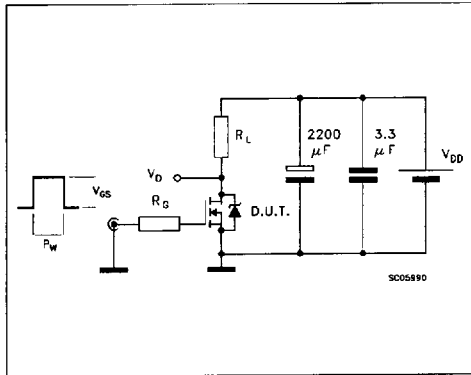

Fig. 1: Switching Times Test Circuits For Resistive Load



Source-drain Diode Forward Characteristics

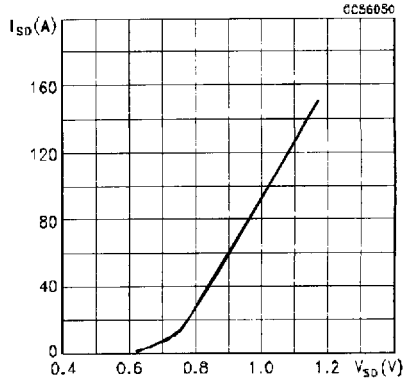

Fig. 2: Gate Charge Test Circuit

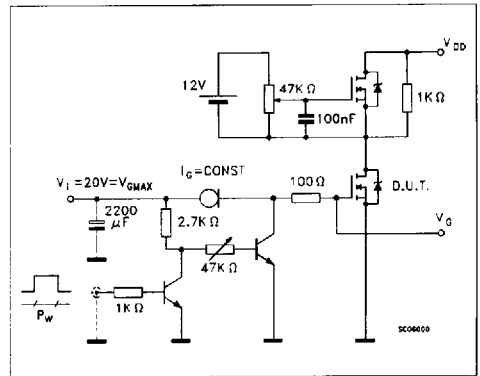

Fig. 3: Test Circuit For Inductive Load Switching And Diode Recovery Times

