

N-channel 650 V, 0.024 Ω typ., 88 A, MDmesh™ V Power MOSFET in a ISOTOP™ package

Datasheet - production data

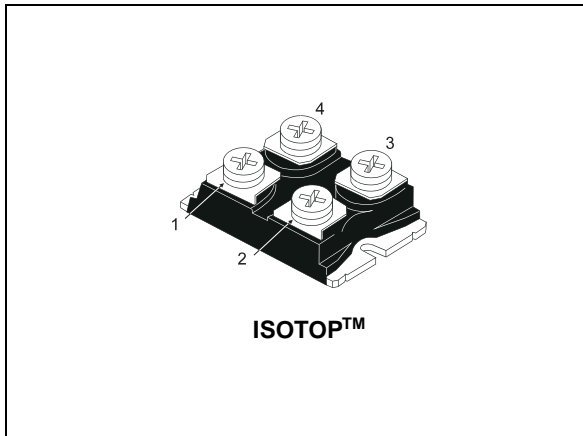
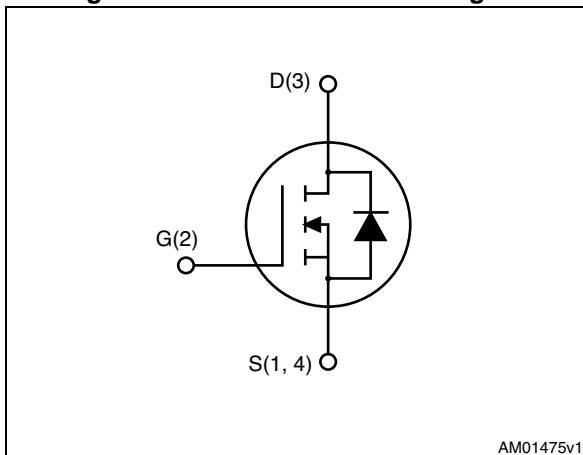

Figure 1. Internal schematic diagram



Features

Order code	$V_{DS} @ T_{jmax}$	$R_{DS(on) max}$	I_D
STE88N65M5	710 V	0.029 Ω	88 A

- Very low $R_{DS(on)}$
- Higher V_{DSS} rating
- Higher dv/dt capability
- Excellent switching performance
- 100% avalanche tested

Applications

- Switching applications

Description

This device is an N-channel MDmesh™ V Power MOSFET based on an innovative proprietary vertical process technology, which is combined with STMicroelectronics' well-known PowerMESH™ horizontal layout structure. The resulting product has extremely low on-resistance, which is unmatched among silicon-based Power MOSFETs, making it especially suitable for applications which require superior power density and outstanding efficiency.

Table 1. Device summary

Order code	Marking	Packages	Packaging
STE88N65M5	88N65M5	ISOTOP	Tube

Contents

1	Electrical ratings	3
2	Electrical characteristics	4
2.1	Electrical characteristics (curves)	6
3	Test circuits	9
4	Package mechanical data	10
5	Revision history	13

1 Electrical ratings

Table 2. Absolute maximum ratings

Symbol	Parameter	Value	Unit
V_{GS}	Gate- source voltage	± 25	V
I_D	Drain current (continuous) at $T_C = 25\text{ }^\circ\text{C}$	88	A
I_D	Drain current (continuous) at $T_C = 100\text{ }^\circ\text{C}$	55.7	A
$I_{DM}^{(1)}$	Drain current (pulsed)	352	A
P_{TOT}	Total dissipation at $T_C = 25\text{ }^\circ\text{C}$	494	W
I_{AR}	Max current during repetitive or single pulse avalanche (pulse width limited by T_{JMAX})	15	A
E_{AS}	Single pulse avalanche energy (starting $T_j = 25\text{ }^\circ\text{C}$, $I_D = I_{AR}$, $V_{DD} = 50\text{V}$)	2000	mJ
$dv/dt^{(2)}$	Peak diode recovery voltage slope	15	V/ns
T_{stg}	Storage temperature	- 55 to 150	$^\circ\text{C}$
T_j	Max. operating junction temperature	150	$^\circ\text{C}$

1. Pulse width limited by safe operating area.

2. $I_{SD} \leq 88\text{ A}$, $di/dt = 400\text{ A}/\mu\text{s}$, $V_{DD} = 400\text{ V}$, $V_{DS (peak)} < V_{(BR)DSS}$.

Table 3. Thermal data

Symbol	Parameter	Value	Unit
$R_{thj-case}$	Thermal resistance junction-case max	0.253	$^\circ\text{C}/\text{W}$
$R_{thj-amb}$	Thermal resistance junction-ambient max	30	$^\circ\text{C}/\text{W}$

2 Electrical characteristics

($T_C = 25\text{ °C}$ unless otherwise specified)

Table 4. On /off states

Symbol	Parameter	Test conditions	Min.	Typ.	Max.	Unit
$V_{(BR)DSS}$	Drain-source breakdown voltage	$I_D = 1\text{ mA}$, $V_{GS} = 0$	650			V
I_{DSS}	Zero gate voltage drain current ($V_{GS} = 0$)	$V_{DS} = 650\text{ V}$			1	μA
		$V_{DS} = 650\text{ V}$, $T_C = 125\text{ °C}$			100	μA
I_{GSS}	Gate-body leakage current ($V_{DS} = 0$)	$V_{GS} = \pm 25\text{ V}$			± 100	nA
$V_{GS(th)}$	Gate threshold voltage	$V_{DS} = V_{GS}$, $I_D = 250\text{ }\mu\text{A}$	3	4	5	V
$R_{DS(on)}$	Static drain-source on- resistance	$V_{GS} = 10\text{ V}$, $I_D = 42\text{ A}$		0.024	0.029	Ω

Table 5. Dynamic

Symbol	Parameter	Test conditions	Min.	Typ.	Max.	Unit
C_{iss}	Input capacitance	$V_{DS} = 100\text{ V}$, $f = 1\text{ MHz}$, $V_{GS} = 0$	-	8825	-	pF
C_{oss}	Output capacitance		-	223	-	pF
C_{rss}	Reverse transfer capacitance		-	11	-	pF
$C_{o(tr)}^{(1)}$	Equivalent capacitance time related	$V_{GS} = 0$, $V_{DS} = 0\text{ to }520\text{ V}$	-	778	-	pF
$C_{o(er)}^{(2)}$	Equivalent capacitance energy related	$V_{GS} = 0$, $V_{DS} = 0\text{ to }520\text{ V}$	-	202	-	pF
R_G	Intrinsic gate resistance	$f = 1\text{ MHz}$ open drain	-	1.79	-	Ω
Q_g	Total gate charge	$V_{DD} = 520\text{ V}$, $I_D = 42\text{ A}$, $V_{GS} = 10\text{ V}$ (see Figure 16)	-	204	-	nC
Q_{gs}	Gate-source charge		-	51	-	nC
Q_{gd}	Gate-drain charge		-	84	-	nC

- $C_{o(tr)}$ is a constant capacitance value that gives the same charging time as C_{oss} while V_{DS} is rising from 0 to 80% V_{DSS} .
- $C_{o(er)}$ is a constant capacitance value that gives the same stored energy as C_{oss} while V_{DS} is rising from 0 to 80% V_{DSS} .

Table 6. Switching times

Symbol	Parameter	Test conditions	Min.	Typ.	Max.	Unit
$t_{d(v)}$	Voltage delay time	$V_{DD} = 400\text{ V}$, $I_D = 56\text{ A}$, $R_G = 4.7\ \Omega$, $V_{GS} = 10\text{ V}$ (see Figure 17) (see Figure 20)	-	141	-	ns
$t_{r(v)}$	Voltage rise time		-	16	-	ns
$t_{f(i)}$	Current fall time		-	29	-	ns
$t_{c(off)}$	Crossing time		-	56	-	ns

Table 7. Source drain diode

Symbol	Parameter	Test conditions	Min.	Typ.	Max.	Unit
I_{SD}	Source-drain current		-		88	A
$I_{SDM}^{(1)}$	Source-drain current (pulsed)		-		352	A
$V_{SD}^{(2)}$	Forward on voltage	$I_{SD} = 88\text{ A}$, $V_{GS} = 0$	-		1.5	V
t_{rr}	Reverse recovery time	$I_{SD} = 84\text{ A}$, $di/dt = 100\text{ A}/\mu\text{s}$ $V_{DD} = 100\text{ V}$ (see Figure 17)	-	544		ns
Q_{rr}	Reverse recovery charge		-	14		μC
I_{RRM}	Reverse recovery current		-	50		A
t_{rr}	Reverse recovery time	$I_{SD} = 84\text{ A}$, $di/dt = 100\text{ A}/\mu\text{s}$ $V_{DD} = 100\text{ V}$, $T_j = 150\text{ }^\circ\text{C}$ (see Figure 17)	-	660		ns
Q_{rr}	Reverse recovery charge		-	20		μC
I_{RRM}	Reverse recovery current		-	60		A

1. Pulse width limited by safe operating area.
2. Pulsed: pulse duration = 300 μs , duty cycle 1.5%

2.1 Electrical characteristics (curves)

Figure 2. Safe operating area

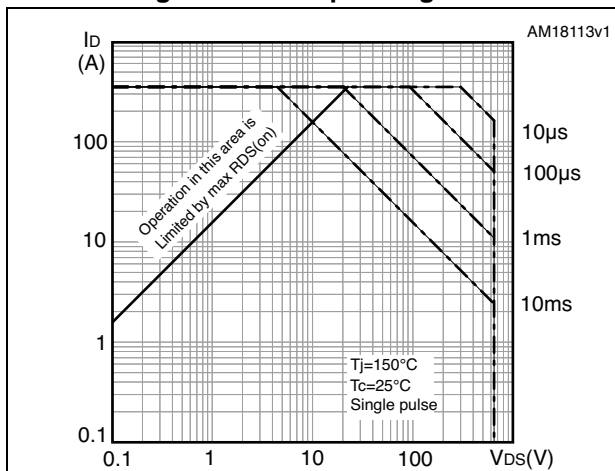

Figure 3. Thermal impedance

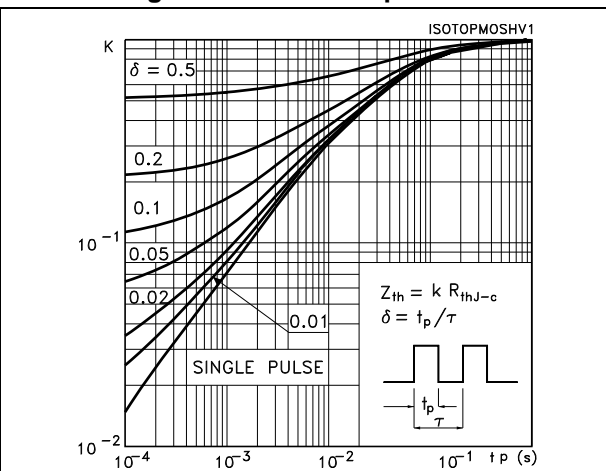

Figure 4. Output characteristics

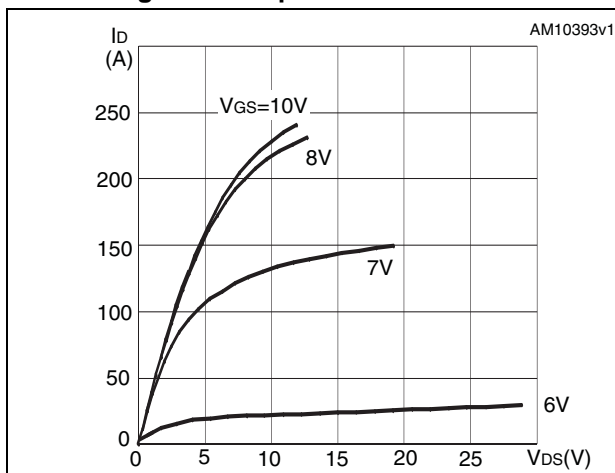

Figure 5. Transfer characteristics

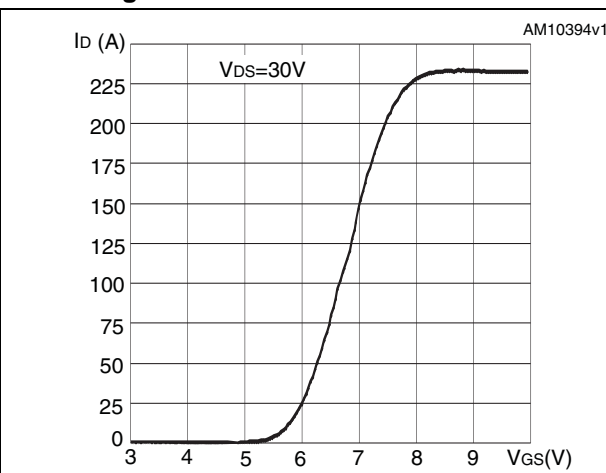

Figure 6. Normalized $V_{(BR)DSS}$ vs temperature

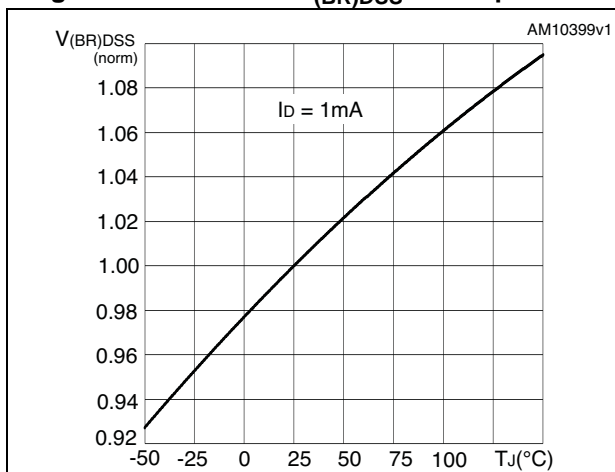

Figure 7. Static drain-source on-resistance

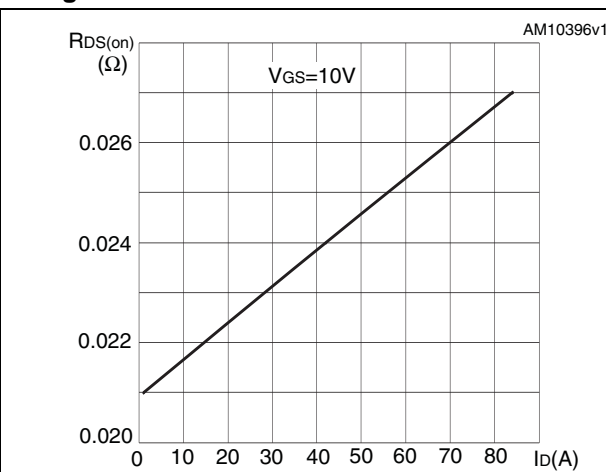

Figure 8. Gate charge vs gate-source voltage

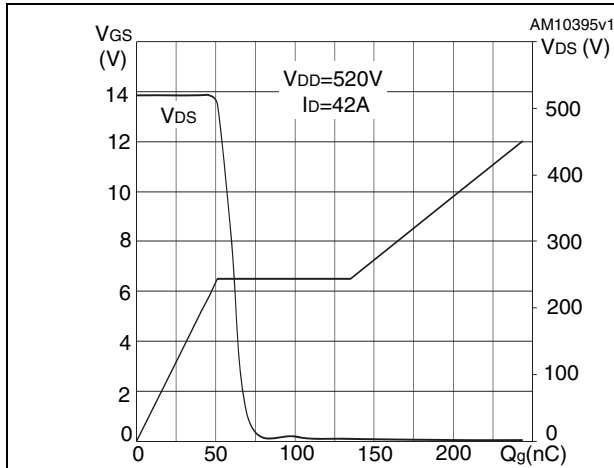

Figure 9. Capacitance variations

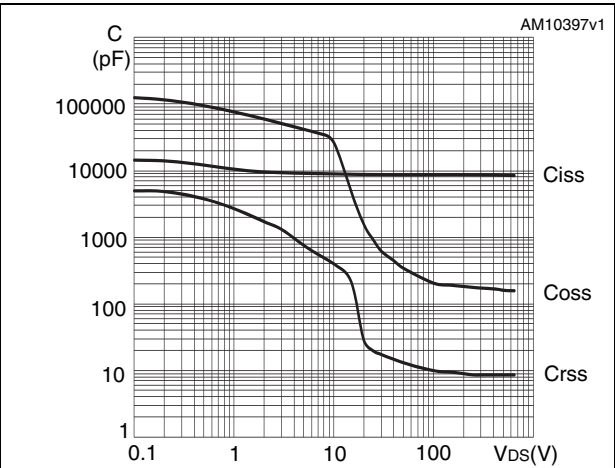

Figure 10. Normalized gate threshold voltage vs temperature

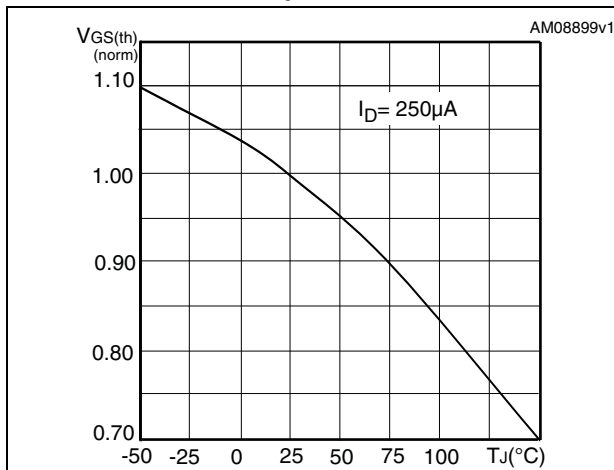

Figure 11. Normalized on-resistance vs temperature

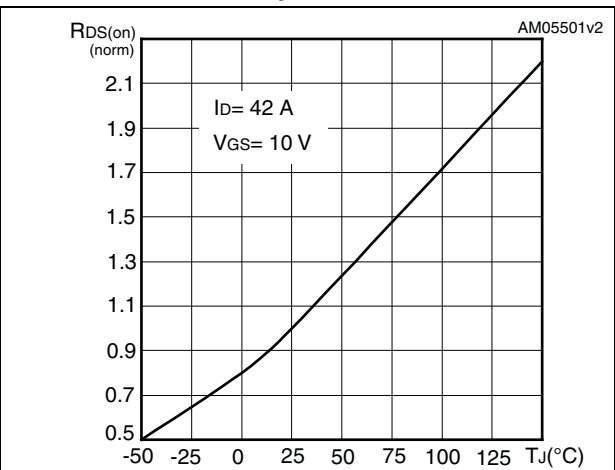

Figure 12. Source-drain diode forward characteristics

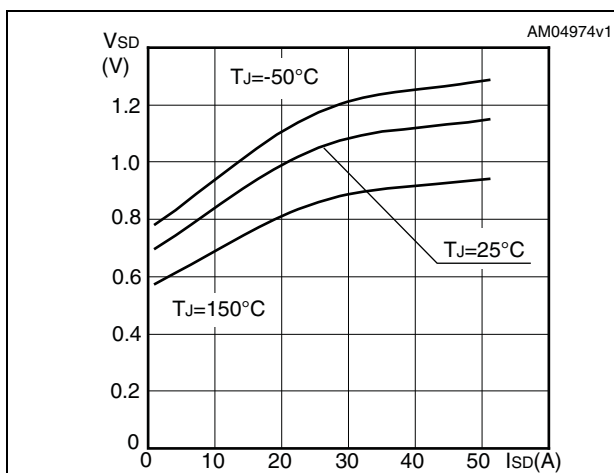

Figure 13. Output capacitance stored energy

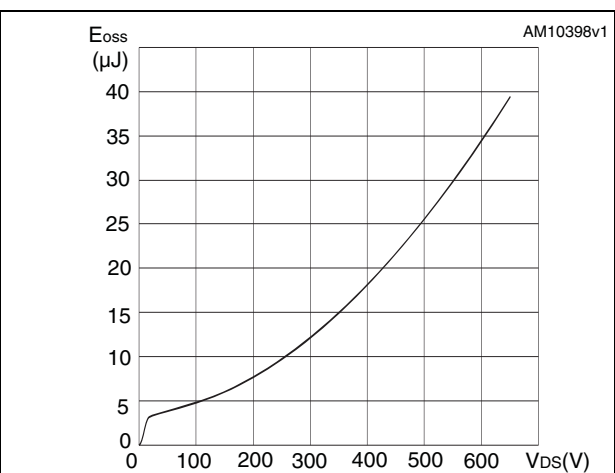
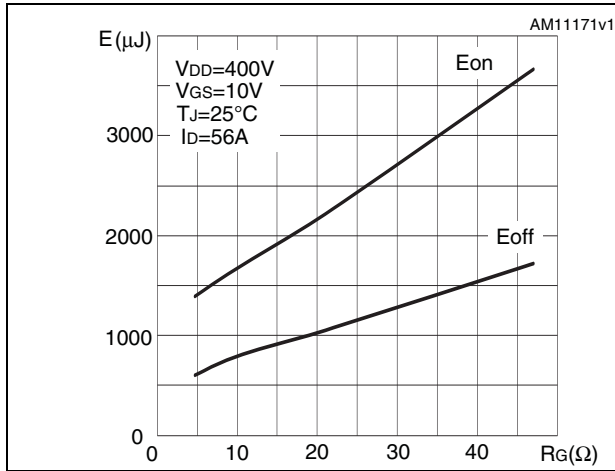

Figure 14. Switching losses vs gate resistance (1)



1. E_{on} including reverse recovery of a SiC diode.

3 Test circuits

Figure 15. Switching times test circuit for resistive load



AM01468v1

Figure 16. Gate charge test circuit



AM01469v1

Figure 17. Test circuit for inductive load switching and diode recovery times



AM01470v1

Figure 18. Unclamped inductive load test circuit



AM01471v1

Figure 19. Unclamped inductive waveform



AM01472v1

Figure 20. Switching time waveform

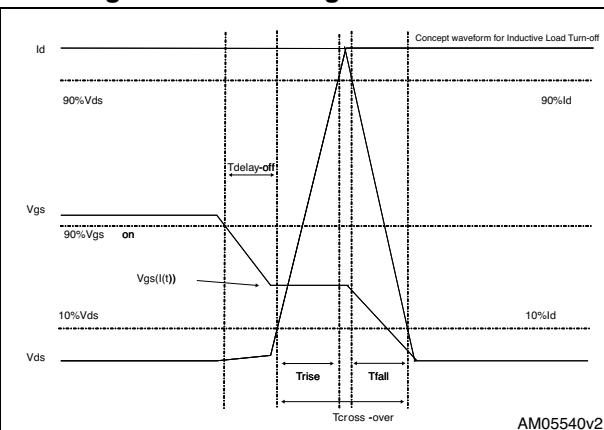

AM05540v2

4 Package mechanical data

In order to meet environmental requirements, ST offers these devices in different grades of ECOPACK[®] packages, depending on their level of environmental compliance. ECOPACK[®] specifications, grade definitions and product status are available at: www.st.com. ECOPACK[®] is an ST trademark.

Figure 21. ISOTOP drawing

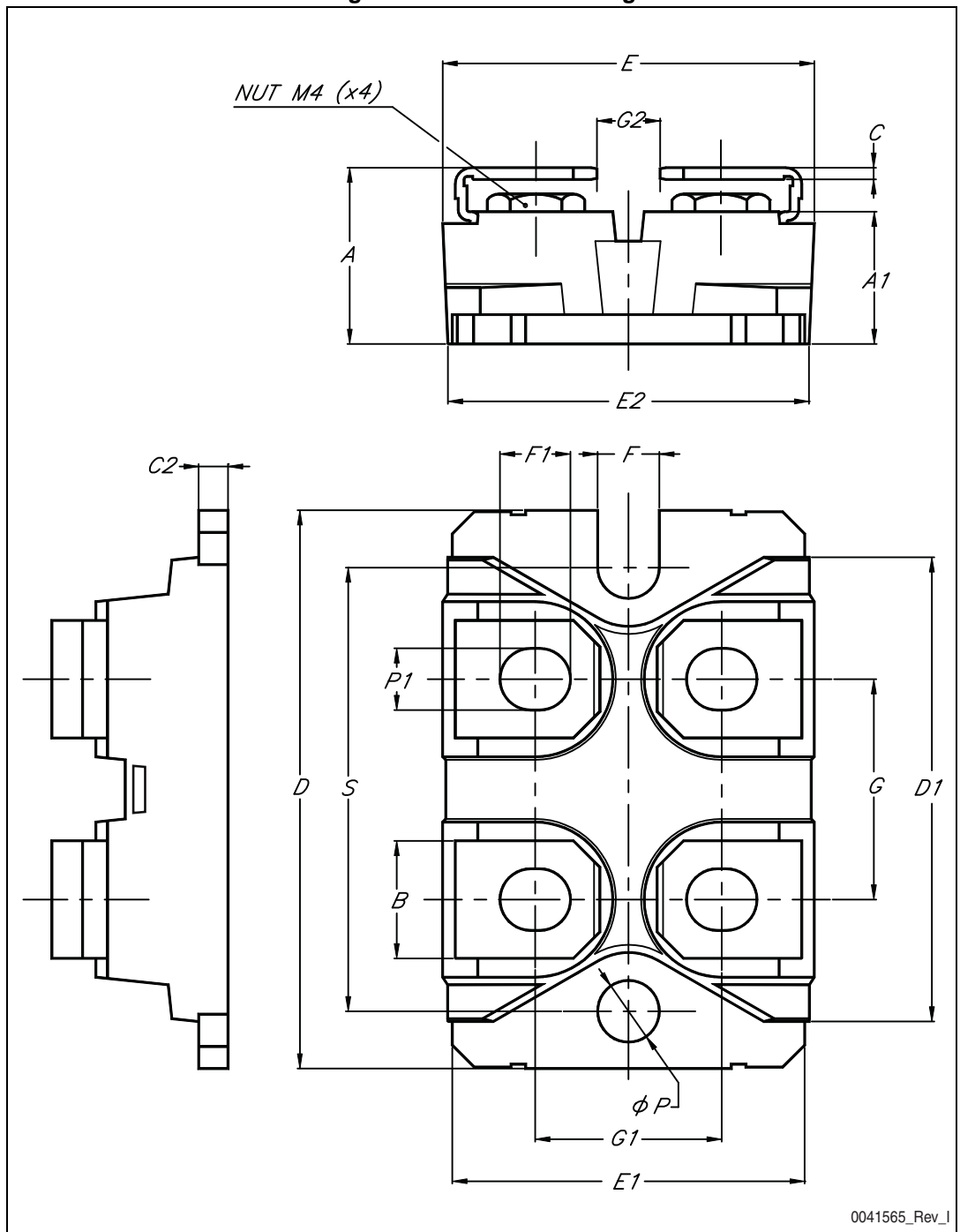

0041565_Rev_I

Table 8. ISOTOP mechanical data

Dim.	mm		
	Min.	Typ.	Max.
A	11.80		12.20
A1	8.90		9.10
B	7.80		8.20
C	0.75		0.85
C2	1.95		2.05
D	37.80		38.20
D1	31.50		31.70
E	25.15		25.50
E1	23.85		24.15
E2		24.80	
G	14.90		15.10
G1	12.60		12.80
G2	3.50		4.30
F	4.10		4.30
F1	4.60		5
φP	4		4.30
P1	4		4.40
S	30.10		30.30

5 Revision history

Table 9. Document revision history

Date	Revision	Changes
24-Feb-2014	1	Initial release.

Please Read Carefully:

Information in this document is provided solely in connection with ST products. STMicroelectronics NV and its subsidiaries ("ST") reserve the right to make changes, corrections, modifications or improvements, to this document, and the products and services described herein at any time, without notice.

All ST products are sold pursuant to ST's terms and conditions of sale.

Purchasers are solely responsible for the choice, selection and use of the ST products and services described herein, and ST assumes no liability whatsoever relating to the choice, selection or use of the ST products and services described herein.

No license, express or implied, by estoppel or otherwise, to any intellectual property rights is granted under this document. If any part of this document refers to any third party products or services it shall not be deemed a license grant by ST for the use of such third party products or services, or any intellectual property contained therein or considered as a warranty covering the use in any manner whatsoever of such third party products or services or any intellectual property contained therein.

UNLESS OTHERWISE SET FORTH IN ST'S TERMS AND CONDITIONS OF SALE ST DISCLAIMS ANY EXPRESS OR IMPLIED WARRANTY WITH RESPECT TO THE USE AND/OR SALE OF ST PRODUCTS INCLUDING WITHOUT LIMITATION IMPLIED WARRANTIES OF MERCHANTABILITY, FITNESS FOR A PARTICULAR PURPOSE (AND THEIR EQUIVALENTS UNDER THE LAWS OF ANY JURISDICTION), OR INFRINGEMENT OF ANY PATENT, COPYRIGHT OR OTHER INTELLECTUAL PROPERTY RIGHT.

ST PRODUCTS ARE NOT DESIGNED OR AUTHORIZED FOR USE IN: (A) SAFETY CRITICAL APPLICATIONS SUCH AS LIFE SUPPORTING, ACTIVE IMPLANTED DEVICES OR SYSTEMS WITH PRODUCT FUNCTIONAL SAFETY REQUIREMENTS; (B) AERONAUTIC APPLICATIONS; (C) AUTOMOTIVE APPLICATIONS OR ENVIRONMENTS, AND/OR (D) AEROSPACE APPLICATIONS OR ENVIRONMENTS. WHERE ST PRODUCTS ARE NOT DESIGNED FOR SUCH USE, THE PURCHASER SHALL USE PRODUCTS AT PURCHASER'S SOLE RISK, EVEN IF ST HAS BEEN INFORMED IN WRITING OF SUCH USAGE, UNLESS A PRODUCT IS EXPRESSLY DESIGNATED BY ST AS BEING INTENDED FOR "AUTOMOTIVE, AUTOMOTIVE SAFETY OR MEDICAL" INDUSTRY DOMAINS ACCORDING TO ST PRODUCT DESIGN SPECIFICATIONS. PRODUCTS FORMALLY ESCC, QML OR JAN QUALIFIED ARE DEEMED SUITABLE FOR USE IN AEROSPACE BY THE CORRESPONDING GOVERNMENTAL AGENCY.

Resale of ST products with provisions different from the statements and/or technical features set forth in this document shall immediately void any warranty granted by ST for the ST product or service described herein and shall not create or extend in any manner whatsoever, any liability of ST.

ST and the ST logo are trademarks or registered trademarks of ST in various countries.

Information in this document supersedes and replaces all information previously supplied.

The ST logo is a registered trademark of STMicroelectronics. All other names are the property of their respective owners.

© 2014 STMicroelectronics - All rights reserved

STMicroelectronics group of companies

Australia - Belgium - Brazil - Canada - China - Czech Republic - Finland - France - Germany - Hong Kong - India - Israel - Italy - Japan - Malaysia - Malta - Morocco - Philippines - Singapore - Spain - Sweden - Switzerland - United Kingdom - United States of America

www.st.com