

1. PART NO. EXPRESSION :

$S T F 0 7 0 3 6 R 0 Y Z F$
 (a) Series code (b) Dimension code (c) Inductance code : 6R0 = 6.0uH (d) Tolerance code : Y = $\pm 40\%$
 (e) X, Y, Z : Standard part (f) F : Lead Free

2. CONFIGURATION & DIMENSIONS :

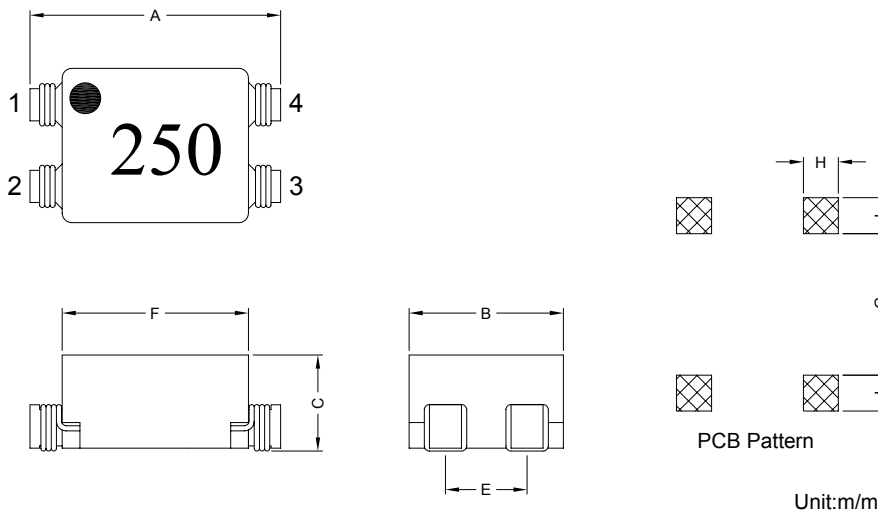

Unit:m/m

A	B	C	E	F	G	H	I
8.00 \pm 0.2	5.30 \pm 0.2	3.50 Max.	2.54 \pm 0.3	5.80 \pm 0.2	5.00 Ref.	1.50 Ref.	1.80 Ref.

3. SCHEMATIC :

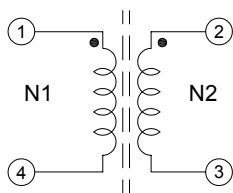

"●": Polarity



RoHS Compliant

NOTE : Specifications subject to change without notice. Please check our website for latest information.

09.05.2008



SUPERWORLD ELECTRONICS (S) PTE LTD

PG. 1

4. MATERIALS :

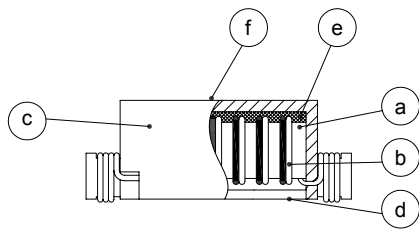

- (a) Core : Ferrite Core
- (b) Wire : Enamelled Copper Wire
- (c) Base : Phenolic
- (d) Cover : Phenolic
- (e) Adhesive : Epoxy
- (f) Ink : Bon Margue

5. GENERAL SPECIFICATION :

- a) Temp. rise : 45°C Max. at rated current
- b) Storage temp. : -40°C to +125°C
- c) Operating temp. : -40°C to +80°C
- d) Resistance to solder heat : 260°C. 10secs

6. ELECTRICAL CHARACTERISTICS :

Part No.	Inductance L1 , L2 (μH)	DC Resistance N1 , N2 (Ω)	Rated Current (A)	Impedance (Ω)	Frequency Range (MHz)
STF07036R0YZF	6.0±40%	0.040 Max.	2.00	90 Min.	20 ~ 1000
STF0703250YZF	25.0±40%	0.070 Max.	1.60	300 Min.	10 ~ 700
STF0703550YZF	55.0±40%	0.130 Max.	1.10	500 Min.	5 ~ 100
STF0703101YZF	100.0±40%	0.220 Max.	0.90	600 Min.	3 ~ 60
STF0703151YZF	150.0±40%	0.420 Max.	0.65	900 Min.	2 ~ 40

* Hi-Pot Test (N1-N2) : 500VAC 60Hz 3mA 1 Minute



RoHS Compliant

NOTE : Specifications subject to change without notice. Please check our website for latest information.

09.05.2008



SUPERWORLD ELECTRONICS (S) PTE LTD

7. IMPEDANCE VS. FREQUENCY :

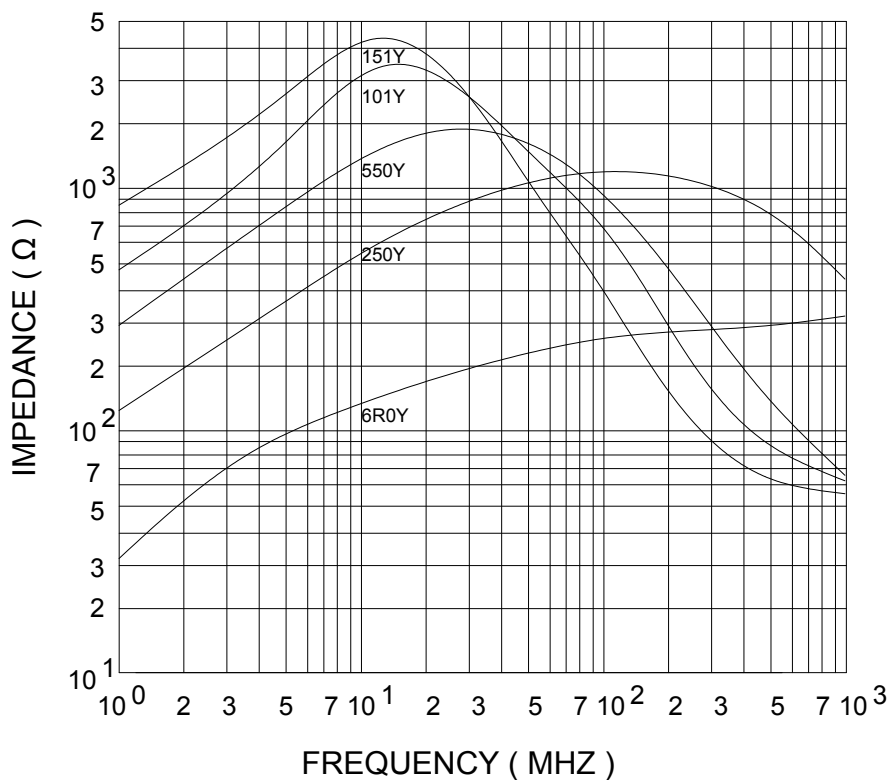

Measuring Circuit :

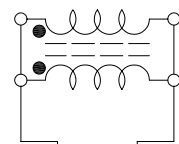

RF Impedance Analyzer



RoHS Compliant

NOTE : Specifications subject to change without notice. Please check our website for latest information.

09.05.2008



SUPERWORLD ELECTRONICS (S) PTE LTD

RECOMMENDED SOLDERING CONDITIONS REFLOW SOLDERINGS

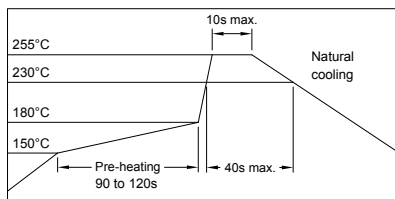

8. PACKAGING INFORMATION :

(1) CONFIGURATION

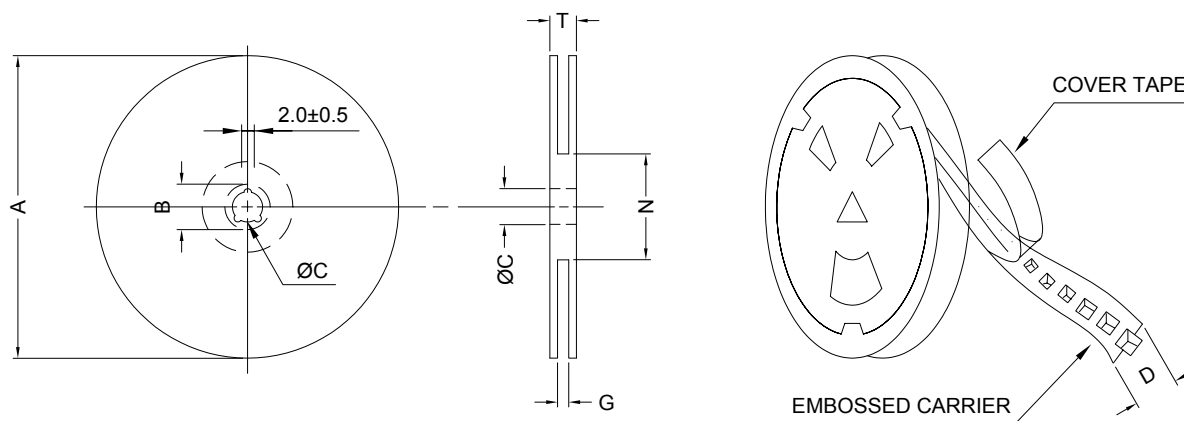

* CARRIER TAPE WIDTH : D

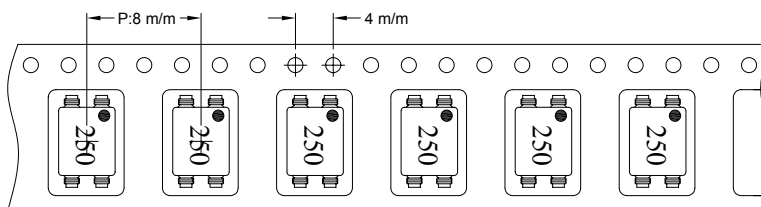

(2) DIMENSIONS

Unit:m/m

STYLE	A	B	C	D	G	N	T
13-16	330	21±0.8	13	16	18 ⁺⁰	50 ⁻⁰	22.4

(3) Q'TY & G.W. PER PACKAGE

SERIES	INNER : REEL			OUTER : CARTON		
	Q'TY (PCS)	G.W. (gw)	STYLE	Q'TY (PCS)	G.W. (Kg)	SIZE (cm)
STF0703	1500	1200	13-16	9000	10.7	40 x 40 x 24



RoHS Compliant

NOTE : Specifications subject to change without notice. Please check our website for latest information.

09.05.2008



SUPERWORLD ELECTRONICS (S) PTE LTD

9. RELIABILITY AND TEST CONDITION :

TEST ITEM	SPECIFICATION	TEST CONDITION
SOLDERABILITY	MORE THAN 90% OF THE TERMINAL ELECTRODE SHALL BE COVERED WITH FRESH SOLDER.	PREHEAT : 125±25°C FOR 60 SECONDS SOLDER : 99%Sn/0.3%Ag/0.7%Cu OR EQUIVALENT SOLDER TEMP. : 245±5°C FLUX : ROSIN DIP TIME : 4±1 SECONDS
THERMAL SHOCK TEST (TEMP. CYCLE)	INDUCTANCE SHALL NOT CHANGE MORE THAN ±20%	ROOM TEMP. → -25±2°C 15 MINUTES → 30 MINUTES ROOM TEMP. → 85±2°C 15 MINUTES → 30 MINUTES TOTAL : 50 CYCLES
HUMIDITY RESISTANCE TEST		TEMPERATURE : 40±2°C HUMIDITY : 90 ~ 95% APPLIED CURRENT : PER SPEC. TIME : 500 HOURS
HIGH TEMP. RESISTANCE TEST		TEMPERATURE : 85±2°C APPLIED CURRENT : PER SPEC. TIME : 500 HOURS



RoHS Compliant

NOTE : Specifications subject to change without notice. Please check our website for latest information.

09.05.2008



SUPERWORLD ELECTRONICS (S) PTE LTD

10. UL CARD :

OBMW2 **November 30, 2000**
Magnet Wire - Component

PACIFIC ELECTRIC WIRE & CABLE (SHENZHEN) CO LTD **E201757**
607 BAOLONG INDUSTRIAL ESTATE LONGGANG, SHENZHEN
GUANGDONG CHINA

Mtl Dsg	Coating Type	TC	ANSI Type	TI
UEW/U	BC Polyurethane	—	—	130
PEW/U	Polyester	—	MW5-C	155°C
PEWH/U	Modified Polyester	—	MW30-C	180
PEW-NY/U	Polyester	Polyamide	MW24-C	155
HAI/U	Polyester(Amide)(Imide)	Polyamideimide	MW35,73	200
UEW-NY/U	Polyurethane	Polyamide	MW80-C	155
			MW28-C	130

Marking: Company name and material designation or marked designation on package or reel, and Recognized Component Mark.

See General Information Preceding These Recognitions

1/3/2001 Underwriters Laboratories Inc. Card 1 of 2

QMFZ2 **May 10, 1995**
Component-Plastics

SUMITOMO BAKELITE CO LTD **E41429 (M)**
(B-cont. from A card)

AM - 3130A	ALL	0.99	94V-0	130	130	130	0	3	—	—	—
		3.0	94V-0	130	130	130	0	2	—	5	0
AM-1120, AM112	BK	0.99	94V-0	130	130	130	—	—	—	—	—
AM-1130, AM-113	BK	0.40	94V-0	130	130	130	—	—	—	—	—
	BK,GN	0.75	94V-0	130	130	130	0	2	—	—	—
	ALL	1.1	94V-0	130	130	130	0	1	—	—	—
		1.5	94V-0	130	130	130	0	1	—	—	—
		3.0	94V-0	130	130	130	0	1	0	5	0
AM-1140, AM-1130, AM-3131, AM-3000, AM-300	ALL	1.1	94V-0	130	130	130	1	0	—	—	—
	BK	1.5	94V-0	130	130	130	1	0	—	—	—
		3.0	94V-0	130	130	130	0	0	0	5	0
	BK	0.74	94V-0	130	130	130	—	—	—	—	—

Reports: November 14,1983, September 16, 1971 : December 31,1973;September 16,1971.

Replaces E41429b dated June 7, 1994. (Cont. on C card)
683540014 N7047 Underwriters Laboratories Inc.® D11/0029309



RoHS Compliant

NOTE : Specifications subject to change without notice. Please check our website for latest information.

09.05.2008



SUPERWORLD ELECTRONICS (S) PTE LTD