

N-channel 800 V, 1.3 Ω typ., 4.5 A MDmesh™ K5 Power MOSFETs in TO-220FP and I²PAKFP packages

Datasheet - production data

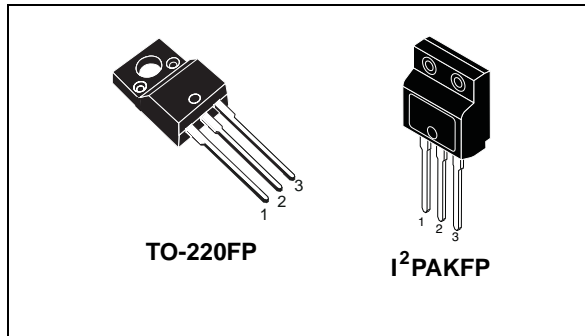
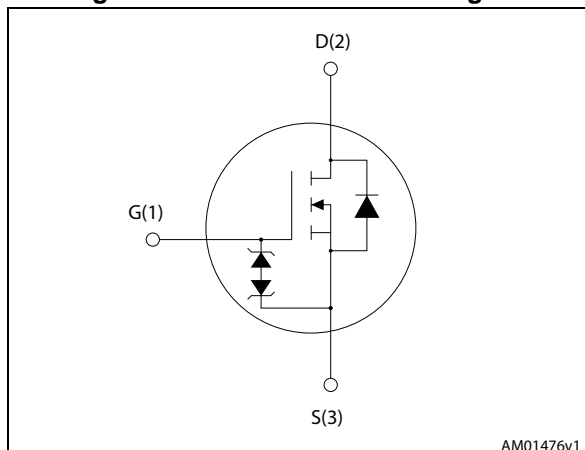

Figure 1. Internal schematic diagram



Features

Order code	V _{DS}	R _{DS(on)} max	I _D	P _{TOT}
STF6N80K5	800 V	1.6 Ω	4.5 A	25 W
STFI6N80K5				

- Industry's lowest R_{DS(on)}
- Industry's best figure of merit (FoM)
- Ultra low gate charge
- 100% avalanche tested
- Zener-protected

Applications

- Switching applications

Description

These very high voltage N-channel Power MOSFETs are designed using MDmesh™ K5 technology based on an innovative proprietary vertical structure. The result is a dramatic reduction in on-resistance and ultra-low gate charge for applications requiring superior power density and high efficiency.

Table 1. Device summary

Order code	Marking	Package	Packing
STF6N80K5	6N80K5	TO-220FP	Tube
STFI6N80K5		I ² PAKFP	

Contents

- 1 Electrical ratings 3**
- 2 Electrical characteristics 4**
 - 2.1 Electrical characteristics (curves) 6
- 3 Test circuits 8**
- 4 Package information 9**
 - 4.1 TO-220FP package information 10
 - 4.2 I²PAKFP (TO-281) package information 12
- 5 Revision history 14**

1 Electrical ratings

Table 2. Absolute maximum ratings

Symbol	Parameter	Value	Unit
V_{GS}	Gate- source voltage	30	V
I_D	Drain current (continuous) at $T_C = 25\text{ °C}$	4.5 ⁽¹⁾	A
I_D	Drain current (continuous) at $T_C = 100\text{ °C}$	2.8	A
$I_{DM}^{(2)}$	Drain current (pulsed)	18	A
P_{TOT}	Total dissipation at $T_C = 25\text{ °C}$	25	W
I_{AR}	Max current during repetitive or single pulse avalanche (pulse width limited by T_{jmax})	1.5	A
E_{AS}	Single pulse avalanche energy (starting $T_J = 25\text{ °C}$, $I_D = I_{AS}$, $V_{DD} = 50\text{ V}$)	85	mJ
$dv/dt^{(3)}$	Peak diode recovery voltage slope	4.5	V/ns
$dv/dt^{(4)}$	MOSFET dv/dt ruggedness	50	V/ns
V_{ISO}	Insulation withstand voltage (RMS) from all three leads to external heat sink ($t = 1\text{ s}$, $T_C = 25\text{ °C}$)	2500	V
T_J	Operating junction temperature range	-55 to 150	°C
T_{stg}	Storage temperature range		

- Limited by maximum junction temperature
- Pulse width limited by safe operating area
- $I_{SD} \leq 4.5\text{ A}$, $di/dt \leq 100\text{ A}/\mu\text{s}$, peak $V_{DS} \leq V_{(BR)DSS}$
- $V_{DS} \leq 640\text{ V}$

Table 3. Thermal data

Symbol	Parameter	Value	Unit
$R_{thj-case}$	Thermal resistance junction-case	5	°C/W
$R_{thj-amb}$	Thermal resistance junction-amb	62.5	

2 Electrical characteristics

($T_{CASE} = 25\text{ °C}$ unless otherwise specified).

Table 4. On/off states

Symbol	Parameter	Test conditions	Min.	Typ.	Max.	Unit
$V_{(BR)DSS}$	Drain-source breakdown voltage ($V_{GS} = 0$)	$I_D = 1\text{ mA}$	800			V
I_{DSS}	Zero gate voltage drain current ($V_{GS} = 0$)	$V_{DS} = 800\text{ V}$			1	μA
		$V_{DS} = 800\text{ V}, T_j = 125\text{ °C}^{(1)}$			50	μA
I_{GSS}	Gate body leakage current ($V_{DS} = 0$)	$V_{GS} = \pm 20\text{ V}$			± 10	μA
$V_{GS(th)}$	Gate threshold voltage	$V_{DS} = V_{GS}, I_D = 100\text{ }\mu\text{A}$	3	4	5	V
$R_{DS(on)}$	Static drain-source on-resistance	$V_{GS} = 10\text{ V}, I_D = 2\text{ A}$		1.3	1.6	Ω

1. Defined by design, not subject to production test.

Table 5. Dynamic

Symbol	Parameter	Test conditions	Min.	Typ.	Max.	Unit
C_{iss}	Input capacitance	$V_{DS} = 100\text{ V},$ $f = 1\text{ MHz},$ $V_{GS} = 0$	-	270	-	pF
C_{oss}	Output capacitance		-	25	-	pF
C_{riss}	Reverse transfer capacitance		-	0.7	-	pF
$C_{o(tr)}^{(1)}$	Equivalent capacitance time related	$V_{GS} = 0, V_{DS} = \text{from } 0 \text{ to } 640\text{ V}$	-	38	-	pF
$C_{o(er)}^{(2)}$	Equivalent capacitance energy related		-	16	-	pF
R_G	Intrinsic gate resistance	$f = 1\text{ MHz}, I_D = 0$	-	7.5	-	Ω
Q_g	Total gate charge	$V_{DD} = 640\text{ V}, I_D = 4.5\text{ A}$ $V_{GS} = 10\text{ V}$ (see Figure 15: Gate charge test circuit)	-	13	-	nC
Q_{gs}	Gate-source charge		-	2.1	-	nC
Q_{gd}	Gate-drain charge		-	9.6	-	nC

1. Time related is defined as a constant equivalent capacitance giving the same charging time as C_{oss} when V_{DS} increases from 0 to 80% V_{DSS}
2. Energy related is defined as a constant equivalent capacitance giving the same stored energy as C_{oss} when V_{DS} increases from 0 to 80% V_{DSS}

Table 6. Switching times

Symbol	Parameter	Test conditions	Min.	Typ.	Max.	Unit
$t_{d(on)}$	Turn-on delay time	$V_{DD} = 400\text{ V}$, $I_D = 2.25\text{ A}$, $R_G = 4.7\ \Omega$, $V_{GS} = 10\text{ V}$ (see Figure 14: Switching times test circuit for resistive load and Figure 19: Switching time waveform)	-	16	-	ns
t_r	Rise time		-	7.5	-	ns
$t_{d(off)}$	Turn-off delay time		-	28.5	-	ns
t_f	Fall time		-	16	-	ns

Table 7. Source drain diode

Symbol	Parameter	Test conditions	Min.	Typ.	Max.	Unit
I_{SD}	Source-drain current		-		4.5	A
$I_{SDM}^{(1)}$	Source-drain current (pulsed)		-		18	A
$V_{SD}^{(2)}$	Forward on voltage	$I_{SD} = 4.5\text{ A}$, $V_{GS} = 0$	-		1.5	V
t_{rr}	Reverse recovery time	$I_{SD} = 4.5\text{ A}$, $V_{DD} = 60\text{ V}$ $di/dt = 100\text{ A}/\mu\text{s}$, (see Figure 16: Test circuit for inductive load switching and diode recovery times)	-	280		ns
Q_{rr}	Reverse recovery charge		-	2.2		μC
I_{RRM}	Reverse recovery current		-	15.5		A
t_{rr}	Reverse recovery time	$I_{SD} = 4.5\text{ A}$, $V_{DD} = 60\text{ V}$ $di/dt = 100\text{ A}/\mu\text{s}$, $T_j = 150\text{ }^\circ\text{C}$ (see Figure 16: Test circuit for inductive load switching and diode recovery times)	-	450		ns
Q_{rr}	Reverse recovery charge		-	3.15		μC
I_{RRM}	Reverse recovery current		-	14		A

1. Pulse width limited by safe operating area
2. Pulsed: pulse duration = 300 μs , duty cycle 1.5%

Table 8. Gate-source Zener diode

Symbol	Parameter	Test conditions	Min.	Typ.	Max.	Unit
$V_{(BR)GSO}$	Gate-source breakdown voltage	$I_{GS} = \pm 1\text{ mA}$, $I_D = 0$	30	-	-	V

The built-in back-to-back Zener diodes are specifically designed to enhance the ESD performance of the device. The Zener voltage facilitates efficient and cost-effective device integrity protection, thus eliminating the need for additional external componentry.

2.1 Electrical characteristics (curves)

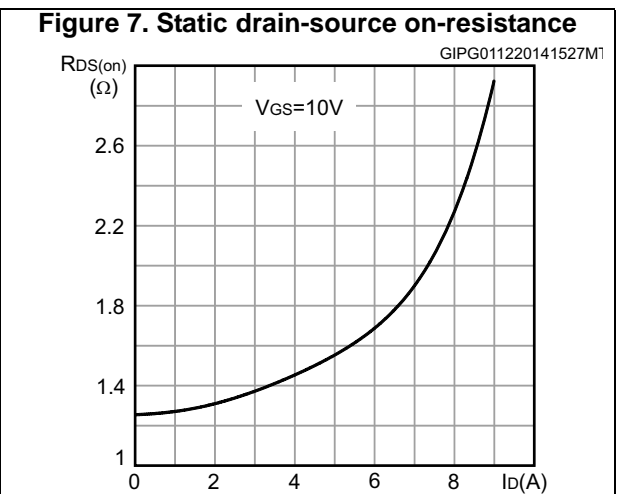
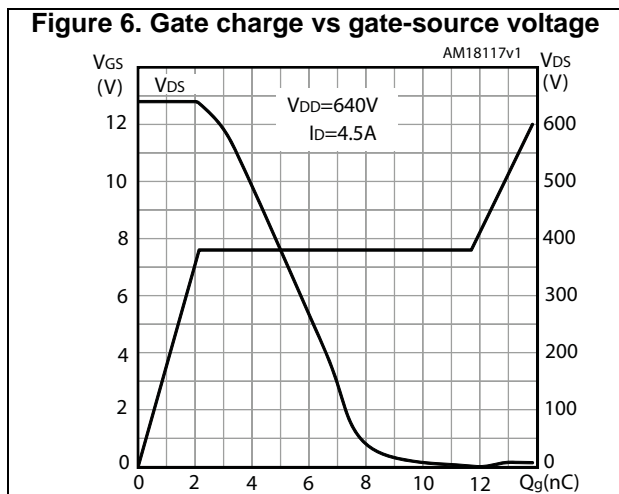
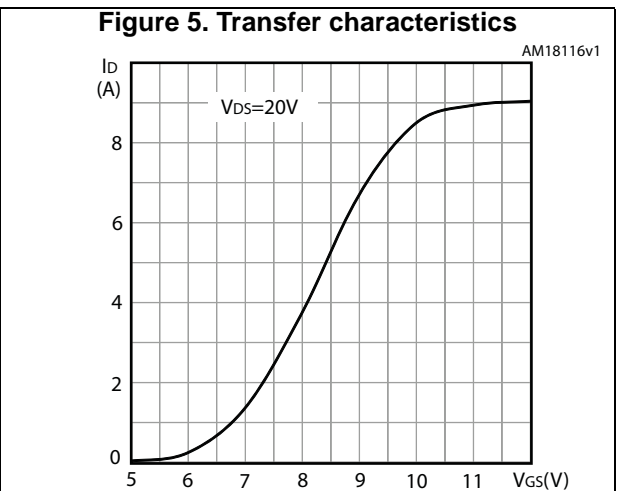
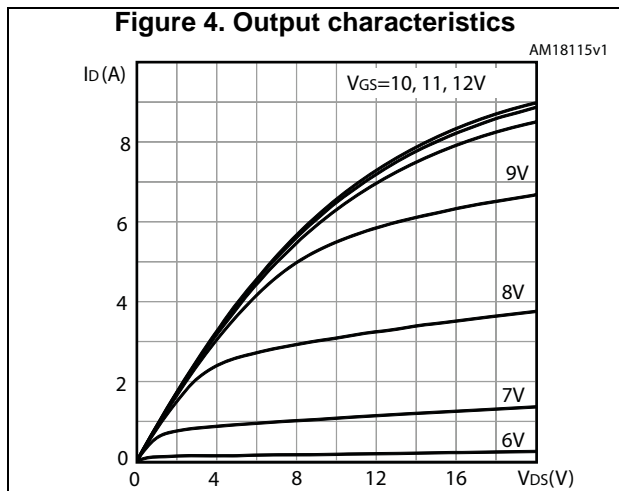
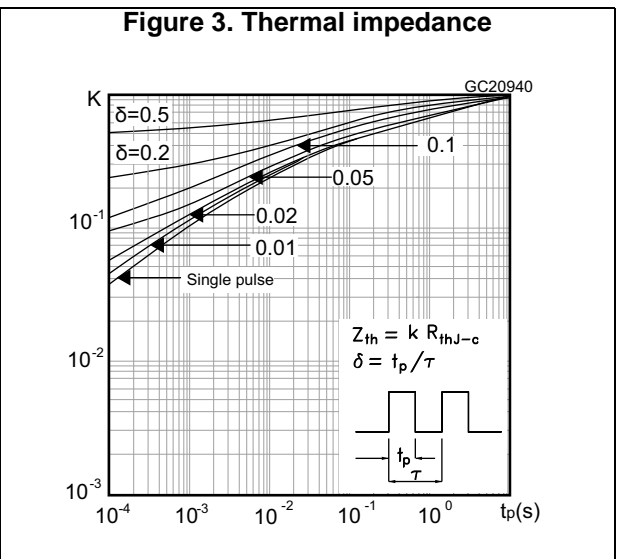
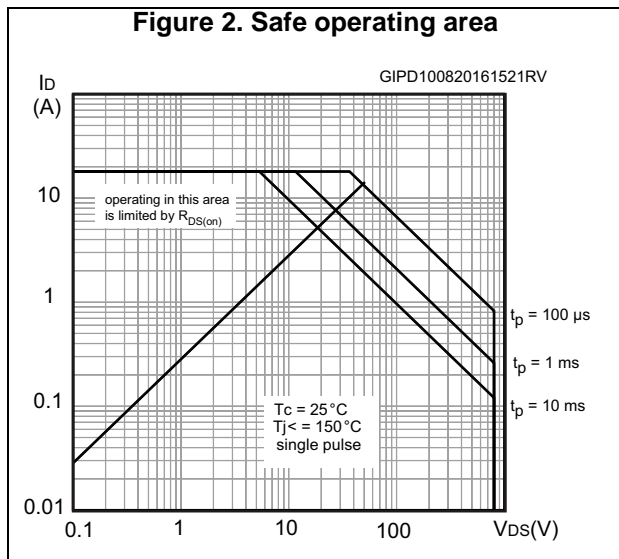

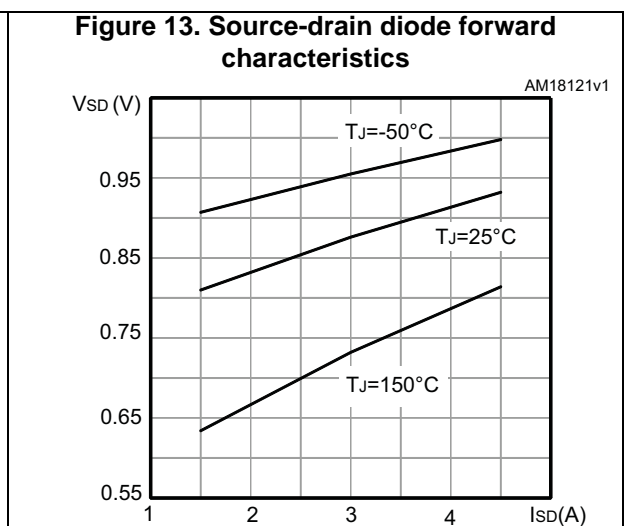
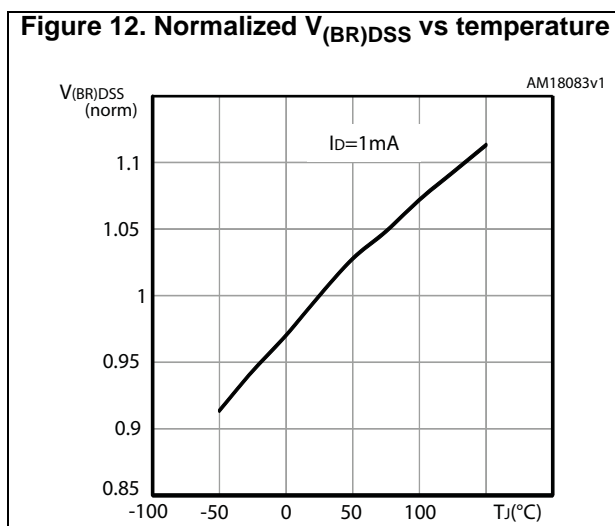
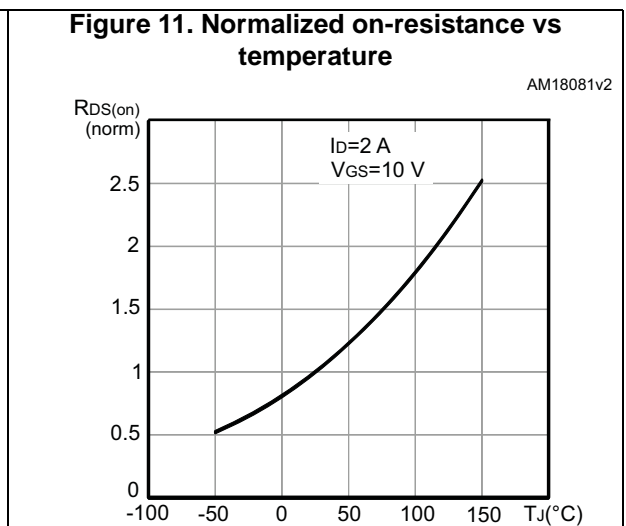
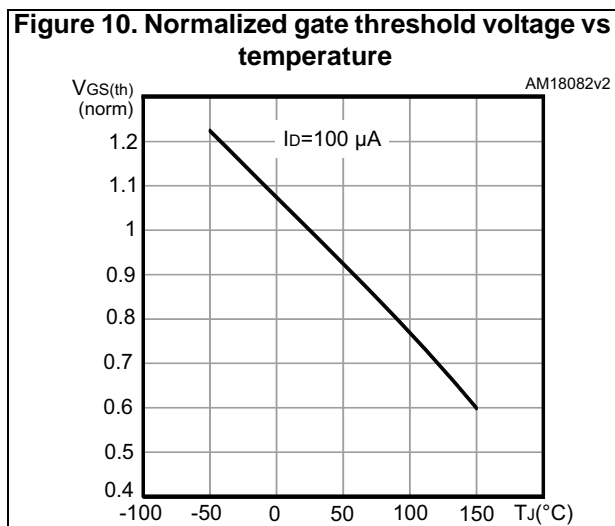
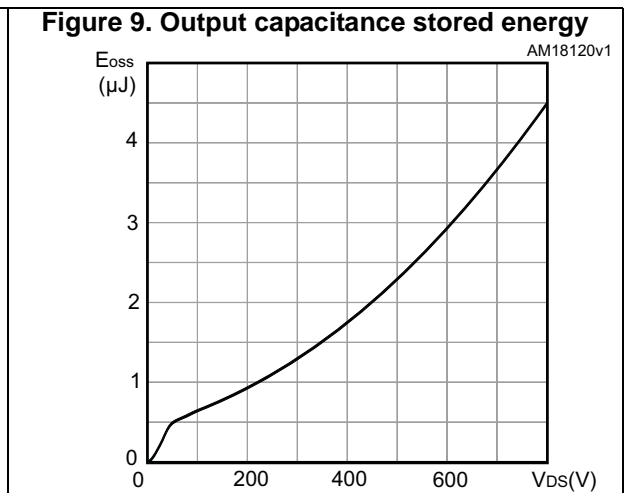
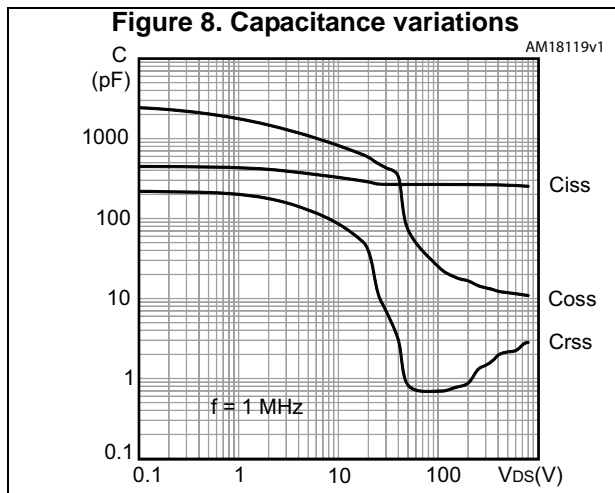

4 Package information

In order to meet environmental requirements, ST offers these devices in different grades of ECOPACK[®] packages, depending on their level of environmental compliance. ECOPACK[®] specifications, grade definitions and product status are available at: www.st.com. ECOPACK[®] is an ST trademark.

4.1 TO-220FP package information

Figure 20. TO-220FP package outline

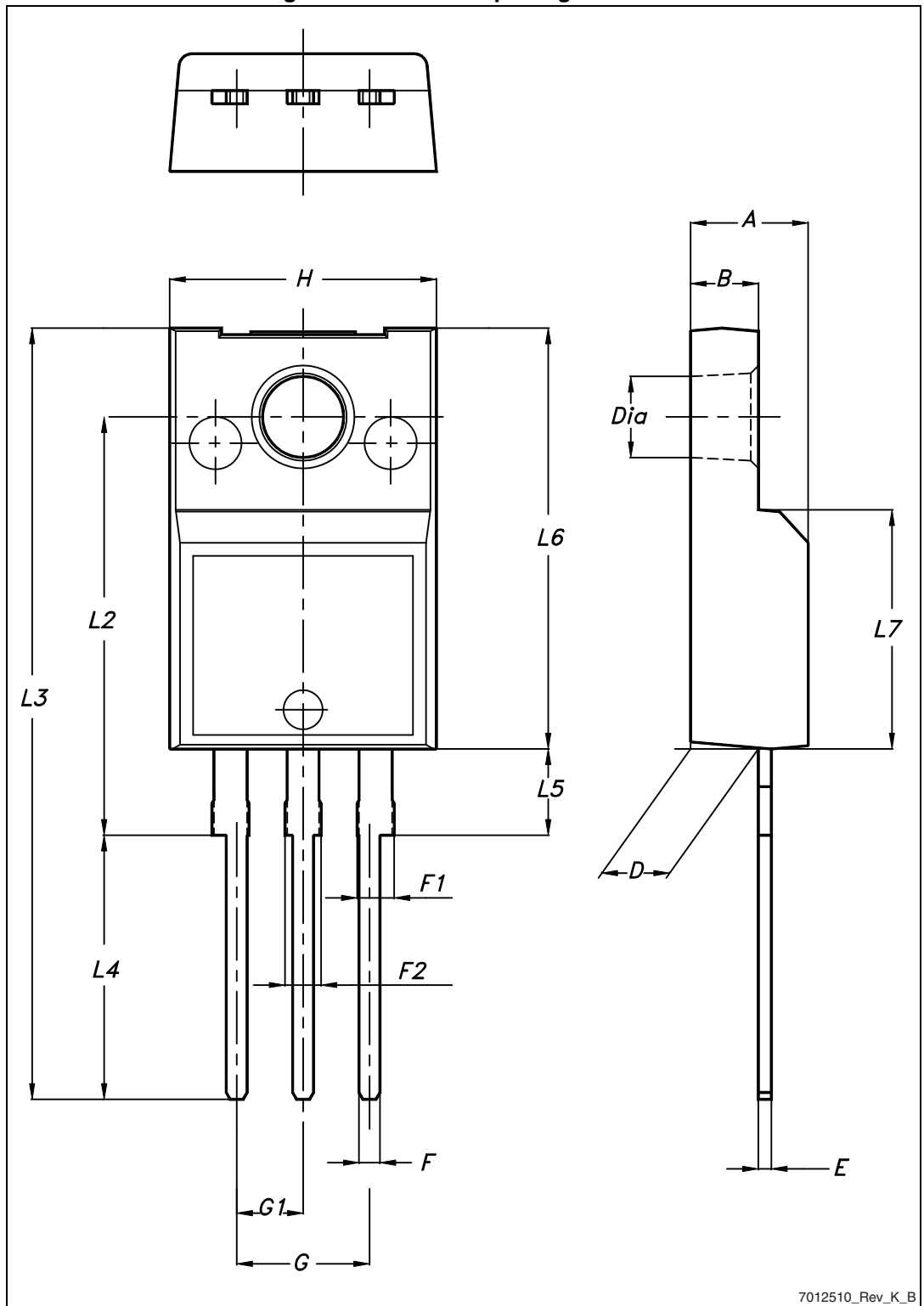

7012510_Rev_K_B

Table 9. TO-220FP mechanical data

Dim.	mm		
	Min.	Typ.	Max.
A	4.4		4.6
B	2.5		2.7
D	2.5		2.75
E	0.45		0.7
F	0.75		1
F1	1.15		1.70
F2	1.15		1.70
G	4.95		5.2
G1	2.4		2.7
H	10		10.4
L2		16	
L3	28.6		30.6
L4	9.8		10.6
L5	2.9		3.6
L6	15.9		16.4
L7	9		9.3
Dia	3		3.2

4.2 I²PAKFP (TO-281) package information

Figure 21. I²PAKFP (TO-281) package outline

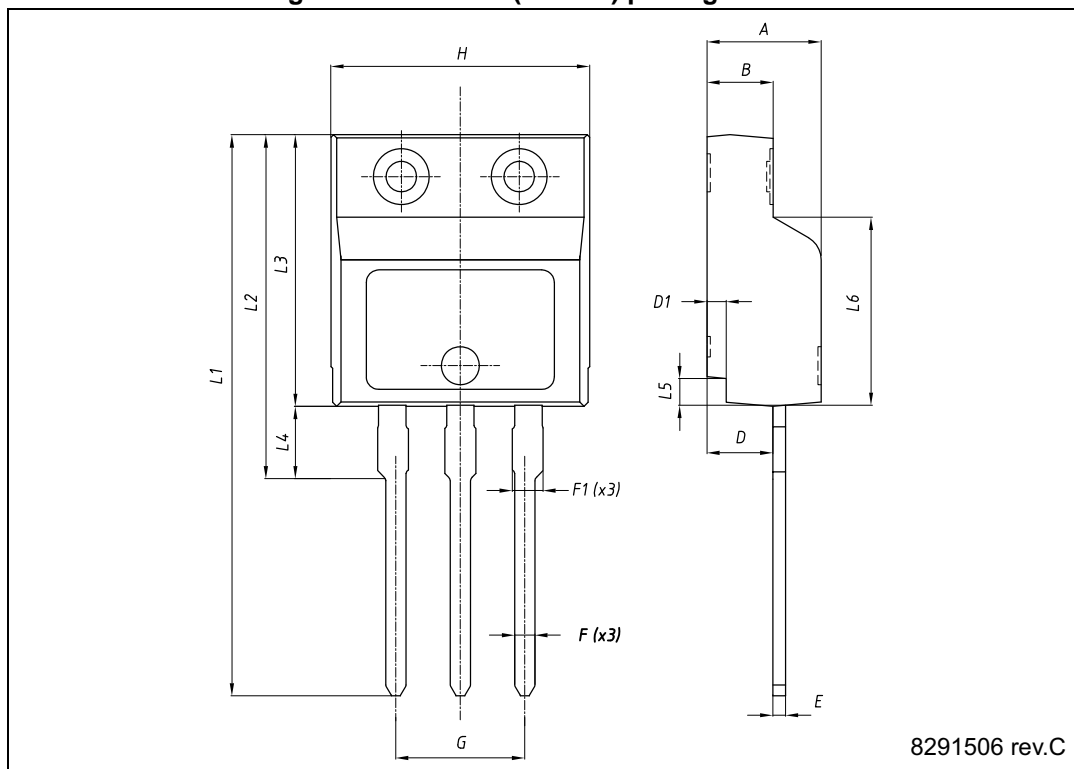

Table 10. I²PAKFP (TO-281) mechanical data

Dim.	mm		
	Min.	Typ.	Max.
A	4.40	-	4.60
B	2.50		2.70
D	2.50		2.75
D1	0.65		0.85
E	0.45		0.70
F	0.75		1.00
F1			1.20
G	4.95		5.20
H	10.00		10.40
L1	21.00		23.00
L2	13.20		14.10
L3	10.55		10.85
L4	2.70		3.20
L5	0.85		1.25
L6	7.50	7.60	7.70

5 Revision history

Table 11. Document revision history

Date	Revision	Changes
28-May-2013	1	First release.
05-Mar-2014	2	<ul style="list-style-type: none"> – Datasheet status promoted from preliminary data to production data – Added: I²PAKFP package – Modified: E_{AS} value in <i>Table 2</i> – Added: MOSFET dv/dt ruggedness test condition and <i>note 4</i> in <i>Table 2</i> – Modified: R_G value in <i>Table 5</i> – Modified: the entire typical values in <i>Table 5, 6 and 7</i> – Added: <i>Section 2.1: Electrical characteristics (curves)</i> – Minor text changes
05-Dec-2014	3	<p>Updated title, features and description in cover page.</p> <p>Updated <i>Section 2.1: Electrical characteristics (curves)</i> and <i>Section 4: Package information</i>.</p> <p>Minor text changes.</p>
06-Sept-2016	4	<p>Updated <i>Table 2: Absolute maximum ratings</i>, <i>Table 4: On/off states</i>, <i>Table 5: Dynamic</i>, <i>Table 6: Switching times</i>, and <i>Table 7: Source drain diode</i>.</p> <p>Updated <i>Figure 2: Safe operating area</i> and <i>Figure 3: Thermal impedance</i>.</p> <p>Minor text changes.</p>

IMPORTANT NOTICE – PLEASE READ CAREFULLY

STMicroelectronics NV and its subsidiaries ("ST") reserve the right to make changes, corrections, enhancements, modifications, and improvements to ST products and/or to this document at any time without notice. Purchasers should obtain the latest relevant information on ST products before placing orders. ST products are sold pursuant to ST's terms and conditions of sale in place at the time of order acknowledgement.

Purchasers are solely responsible for the choice, selection, and use of ST products and ST assumes no liability for application assistance or the design of Purchasers' products.

No license, express or implied, to any intellectual property right is granted by ST herein.

Resale of ST products with provisions different from the information set forth herein shall void any warranty granted by ST for such product.

ST and the ST logo are trademarks of ST. All other product or service names are the property of their respective owners.

Information in this document supersedes and replaces information previously supplied in any prior versions of this document.

© 2016 STMicroelectronics – All rights reserved

