



# STGE50NC60WD

N-channel 50A - 600V - ISOTOP  
Ultra fast switching PowerMESH™ IGBT

## Features

Type	V <sub>CES</sub>	V <sub>CE(sat)</sub> (Max) @25°C	I <sub>C</sub> @100°C
STGE50NC60WD	600V	2.5V	50A

- High current capability
- High frequency operation
- Low C<sub>RES</sub>/C<sub>IES</sub> ratio (no cross-conduction susceptibility)
- Very soft ultra fast recovery antiparallel diode

## Description

Using the latest high voltage technology based on a patented strip layout, STMicroelectronics has designed an advanced family of IGBTs, the PowerMESH™ IGBTs, with outstanding performances. The suffix "W" identifies a family optimized for very high frequency applications.

## Applications

- Very high frequency inverters
- HF, SMPS and PFC in both hard switching and resonant topologies
- UPS
- Motor drivers
- Welding

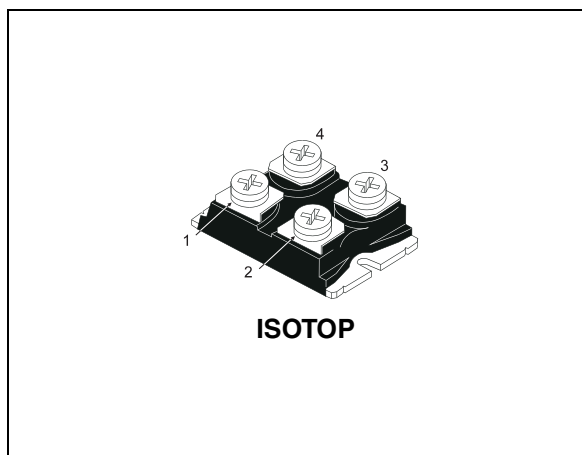

Figure 1. Internal schematic diagram

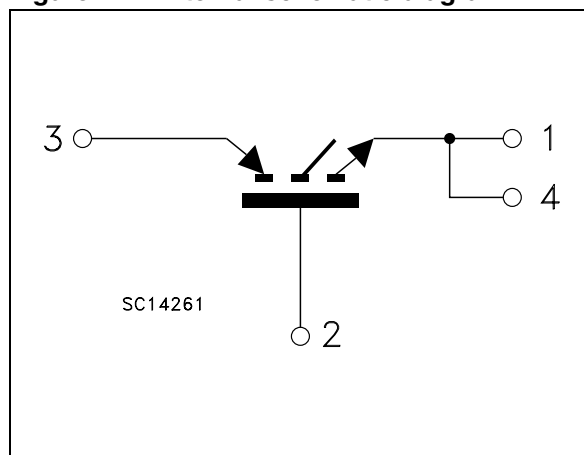

Table 1. Device summary

Order code	Marking	Package	Packaging
STGE50NC60WD	GE50NC60WD	ISOTOP	Tube

# Contents

<b>1</b>	<b>Electrical ratings</b> .....	<b>3</b>
<b>2</b>	<b>Electrical characteristics</b> .....	<b>4</b>
	2.1 Electrical characteristics (curves) .....	7
<b>3</b>	<b>Test circuit</b> .....	<b>10</b>
<b>4</b>	<b>Package mechanical data</b> .....	<b>11</b>
<b>5</b>	<b>Revision History</b> .....	<b>13</b>

# 1 Electrical ratings

**Table 2. Absolute maximum ratings**

Symbol	Parameter	Value	Unit
$V_{CES}$	Collector-emitter voltage ( $s_{GS} = 0$ )	600	V
$I_C^{(1)}$	Collector current (continuous) at $T_C = 25^\circ\text{C}$	100	A
$I_C^{(1)}$	Collector current (continuous) at $T_C = 100^\circ\text{C}$	50	A
$I_{CL}^{(2)}$	Collector current (pulsed)	250	A
$V_{GE}$	Gate-emitter voltage	$\pm 20$	V
$I_F$	Diode RMS forward current at $T_C = 25^\circ\text{C}$	30	A
$P_{TOT}$	Total dissipation at $T_C = 25^\circ\text{C}$	260	W
$T_{stg}$	Storage temperature	-55 to 150	$^\circ\text{C}$
$T_j$	Operating junction temperature		

1. Calculated according to the iterative formula:

$$I_C(T_C) = \frac{T_{JMAX} - T_C}{R_{THJ-C} \times V_{CESAT(MAX)}(T_C, I_C)}$$

2. Pulse width limited by  $T_{jmax}$

**Table 3. Thermal resistance**

Symbol	Parameter	Min	Typ	Max	Unit
Rthj-case	Thermal resistance junction-case (IGBT)	--	--	0.48	$^\circ\text{C}/\text{W}$
Rthj-case	Thermal resistance junction-case (diode)	--	--	1.5	$^\circ\text{C}/\text{W}$
Rthj-amb	Thermal resistance junction-amb	--	--	50	$^\circ\text{C}/\text{W}$

## 2 Electrical characteristics

( $T_J = 25\text{ }^\circ\text{C}$  unless otherwise specified)

**Table 4. Static**

Symbol	Parameter	Test conditions	Min.	Typ.	Max.	Unit
$V_{BR(CES)}$	Collector-emitter breakdown voltage	$I_C = 1\text{ mA}$ , $V_{GE} = 0$	600			V
$V_{CE(sat)}$	Collector-emitter saturation voltage	$V_{GE} = 15\text{ V}$ , $I_C = 40\text{ A}$ $V_{GE} = 15\text{ V}$ , $I_C = 40\text{ A}$ , $T_C = 125\text{ }^\circ\text{C}$		2.1 1.9	2.6	V V
$V_{GE(th)}$	Gate threshold voltage	$V_{CE} = V_{GE}$ , $I_C = 250\text{ }\mu\text{A}$	3.75		5.75	V
$I_{CES}$	Collector cut-off current ( $V_{GE} = 0$ )	$V_{CE} = \text{Max rating}$ , $T_C = 25\text{ }^\circ\text{C}$ $V_{CE} = \text{Max rating}$ , $T_C = 125\text{ }^\circ\text{C}$			500 5	$\mu\text{A}$ mA
$I_{GES}$	Gate-emitter leakage current ( $V_{CE} = 0$ )	$V_{GE} = \pm 20\text{ V}$ , $V_{CE} = 0$			$\pm 100$	nA
$g_{fs}$	Forward transconductance	$V_{CE} = 15\text{ V}$ , $I_C = 40\text{ A}$		25		S

**Table 5. Dynamic**

Symbol	Parameter	Test conditions	Min.	Typ.	Max.	Unit
$C_{ies}$	Input capacitance	$V_{CE} = 25\text{ V}$ , $f = 1\text{ MHz}$ , $V_{GE} = 0$		4700		pF
$C_{oes}$	Output capacitance			410		pF
$C_{res}$	Reverse transfer capacitance			90		pF
$Q_g$	Total gate charge	$V_{CE} = 390\text{ V}$ , $I_C = 40\text{ A}$ ,		195		nC
$Q_{ge}$	Gate-emitter charge	$V_{GE} = 15\text{ V}$ ,		32		nC
$Q_{gc}$	Gate-collector charge	<a href="#">Figure 17</a>		82		nC

**Table 6. Switching on/off (inductive load)**

Symbol	Parameter	Test conditions	Min.	Typ.	Max.	Unit
$t_{d(on)}$	Turn-on delay time	$V_{CC} = 390V, I_C = 40A$		52		ns
$t_r$	Current rise time	$R_G = 3.3\Omega, V_{GE} = 15V,$		17		ns
$(di/dt)_{on}$	Turn-on current slope	<i>Figure 16, Figure 18</i>		2400		A/ $\mu$ s
$t_{d(on)}$	Turn-on delay time	$V_{CC} = 390V, I_C = 40A$		50		ns
$t_r$	Current rise time	$R_G = 3.3\Omega, V_{GE} = 15V,$		19		ns
$(di/dt)_{on}$	Turn-on current slope	$T_j = 125^\circ C$ <i>Figure 16, Figure 18</i>		2020		A/ $\mu$ s
$t_{r(Voff)}$	Off voltage rise time	$V_{CC} = 390V, I_C = 40A$		31		ns
$t_{d(Voff)}$	Turn-off delay time	$R_G = 3.3\Omega, V_{GE} = 15V,$		240		ns
$t_f$	Current fall time	<i>Figure 16, Figure 18</i>		35		ns
$t_{r(Voff)}$	Off voltage rise time	$V_{CC} = 390V, I_C = 40A$		59		ns
$t_{d(Voff)}$	Turn-off delay time	$R_G = 3.3\Omega, V_{GE} = 15V,$		280		ns
$t_f$	Current fall time	$T_j = 125^\circ C$ <i>Figure 16, Figure 18</i>		63		ns

**Table 7. Switching energy (inductive load)**

Symbol	Parameter	Test conditions	Min.	Typ.	Max.	Unit
$E_{on}^{(1)}$	Turn-on switching losses	$V_{CC} = 390V, I_C = 40A$		365	470	$\mu$ J
$E_{off}^{(2)}$	Turn-off switching losses	$R_G = 3.3\Omega, V_{GE} = 15V,$		560	790	$\mu$ J
$E_{ts}$	Total switching losses	<i>Figure 18</i>		925	1260	$\mu$ J
$E_{on}^{(1)}$	Turn-on switching losses	$V_{CC} = 390V, I_C = 40A$		635		$\mu$ J
$E_{off}^{(2)}$	Turn-off switching losses	$R_G = 3.3\Omega, V_{GE} = 15V,$		910		$\mu$ J
$E_{ts}$	Total switching losses	$T_j = 125^\circ C$ <i>Figure 18</i>		1545		$\mu$ J

1.  $E_{on}$  is the turn-on losses when a typical diode is used in the test circuit in *Figure 18*. If the IGBT is offered in a package with a co-pak diode, the co-pak diode is used as external diode. IGBTs & Diode are at the same temperature (25°C and 125°C)
2. Turn-off losses include also the tail of the collector current

Table 8. Collector-emitter diode

Symbol	Parameter	Test conditions	Min.	Typ.	Max.	Unit
$V_f$	Forward on-voltage	$I_f = 15A$		1.5	2.9	V
		$I_f = 15A, T_j = 125^\circ C$		1.2		V
		$I_f = 40A, T_j = 125^\circ C$		1.35		V
$t_{rr}$	Reverse recovery time	$I_f = 40A, V_R = 50V,$		55		ns
$Q_{rr}$	Reverse recovery charge	$T_j = 25^\circ C, di/dt = 100 A/\mu s$		100		nC
$I_{rrm}$	Reverse recovery current	<a href="#">Figure 19</a>		3.6		A
$t_{rr}$	Reverse recovery time	$I_f = 40A, V_R = 50V,$		164		ns
$Q_{rr}$	Reverse recovery charge	$T_j = 125^\circ C, di/dt = 100A/\mu s$		525		nC
$I_{rrm}$	Reverse recovery current	<a href="#">Figure 19</a>		6.4		A

## 2.1 Electrical characteristics (curves)

Figure 2. Output characteristics

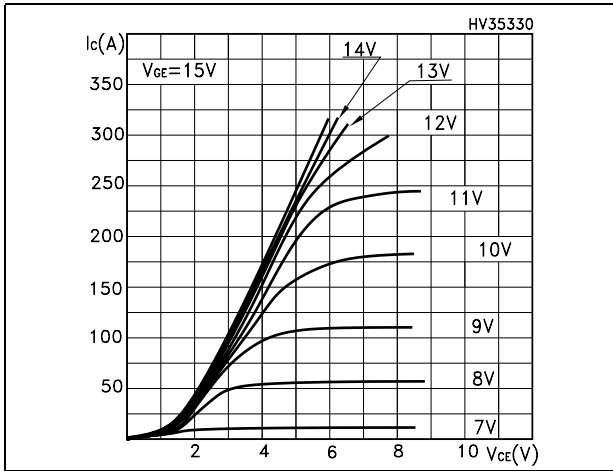

Figure 3. Transfer characteristics

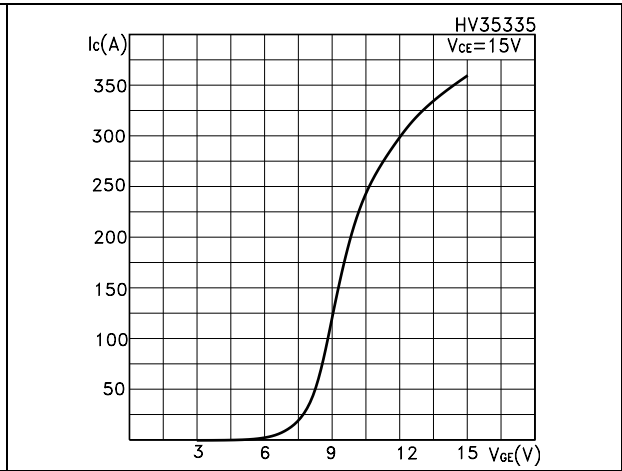

Figure 4. Transconductance

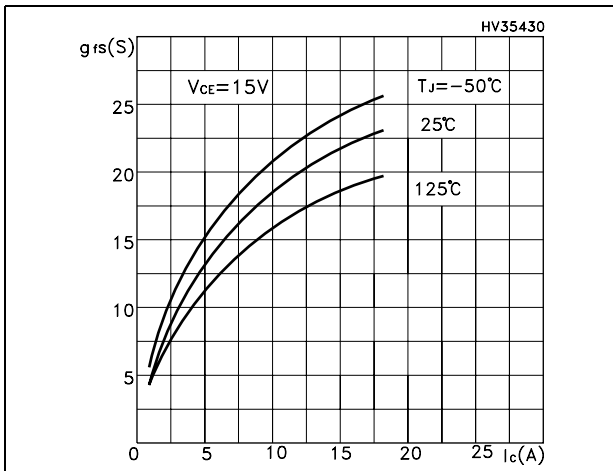

Figure 5. Collector-emitter on voltage vs temperature

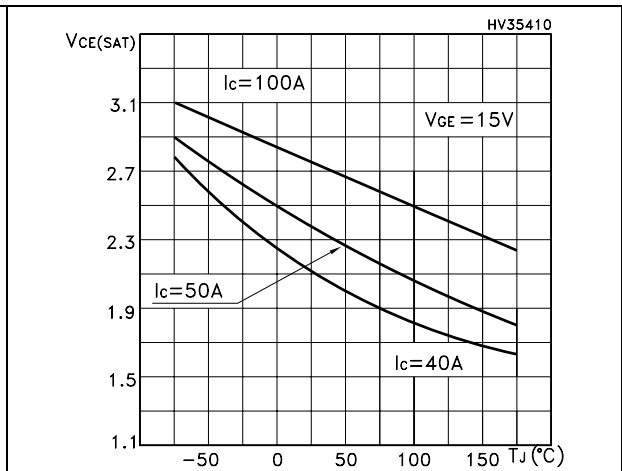
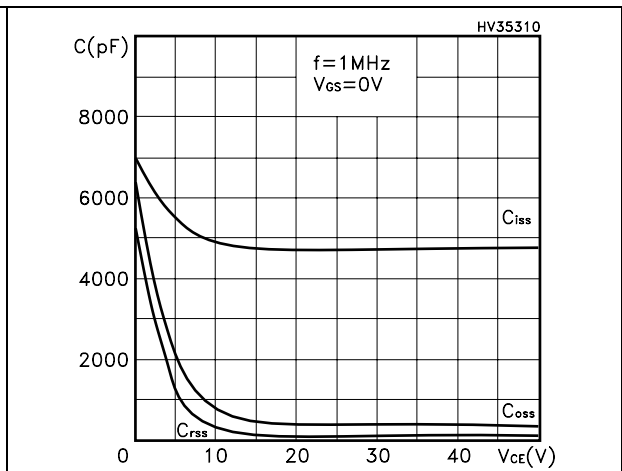
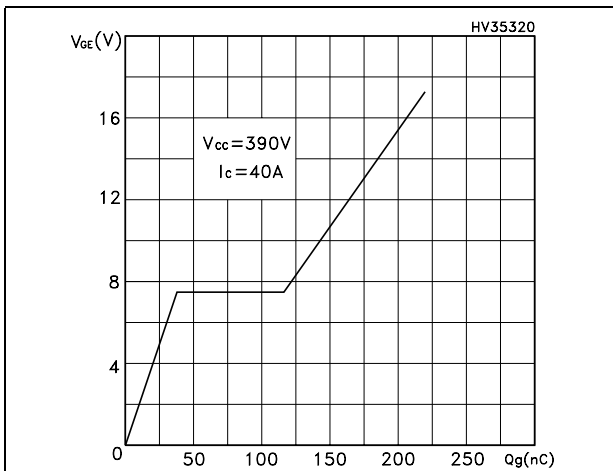
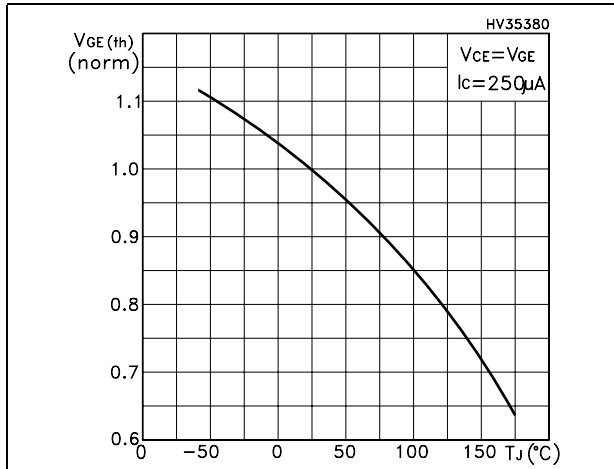

Figure 6. Gate charge vs gate-source voltage Figure 7. Capacitance variations



**Figure 8. Normalized gate threshold voltage vs temperature**



**Figure 9. Collector-emitter on voltage vs collector current**

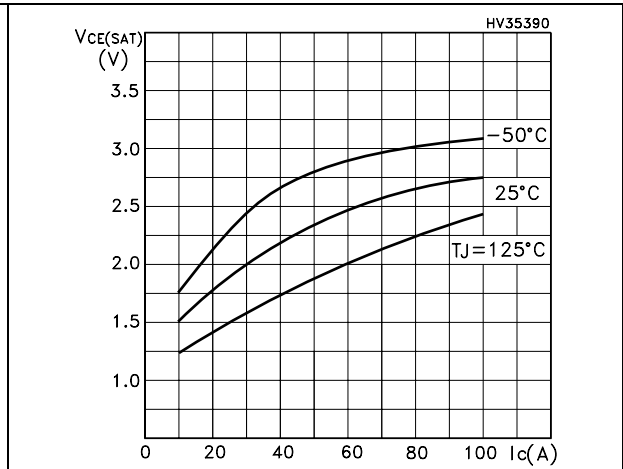

**Figure 10. Normalized breakdown voltage vs temperature**

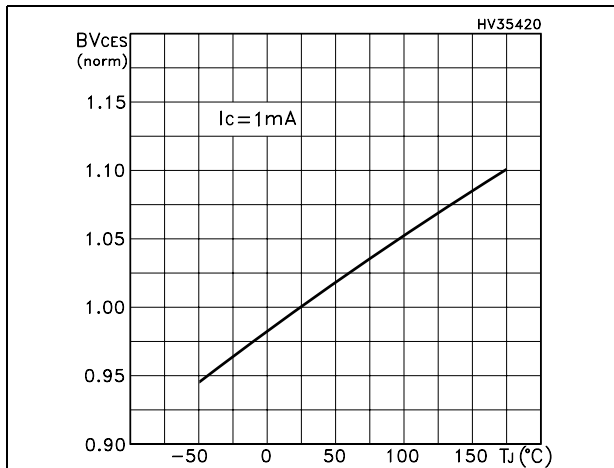

**Figure 11. Switching losses vs temperature**

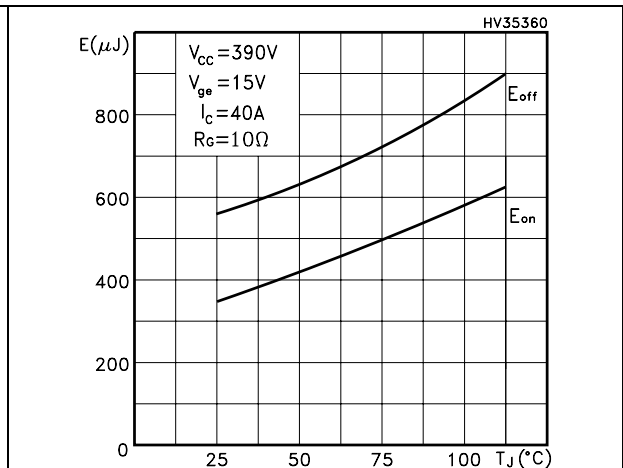

**Figure 12. Switching losses vs gate resistance**

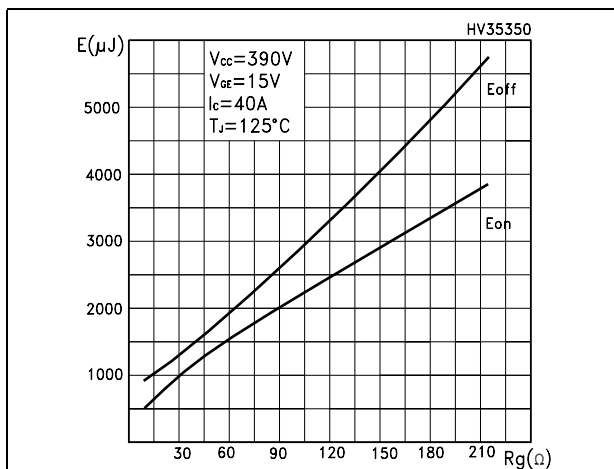

**Figure 13. Switching losses vs collector current**

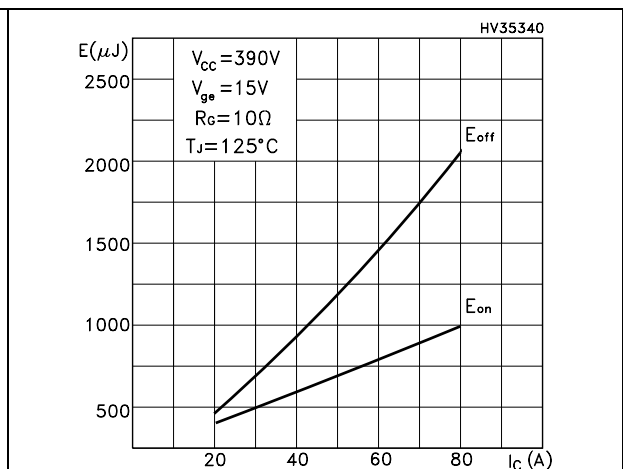



Figure 14. Turn-off SOA

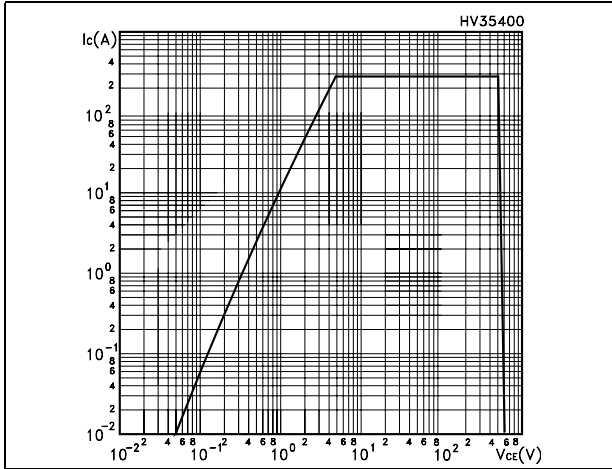
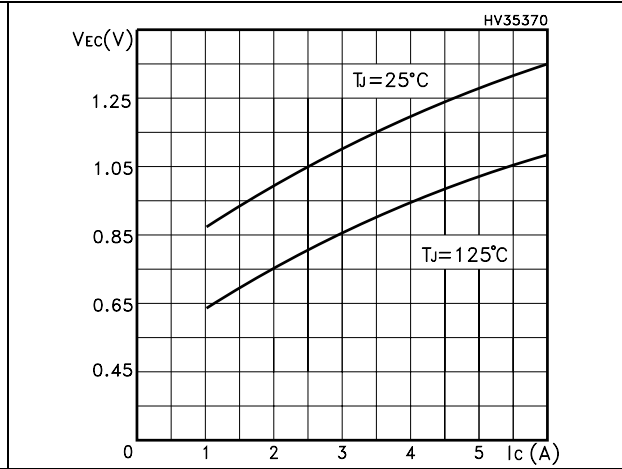

Figure 15. Emitter-collector diode characteristics





## 4 Package mechanical data

In order to meet environmental requirements, ST offers these devices in ECOPACK® packages. These packages have a Lead-free second level interconnect. The category of second level interconnect is marked on the package and on the inner box label, in compliance with JEDEC Standard JESD97. The maximum ratings related to soldering conditions are also marked on the inner box label. ECOPACK is an ST trademark. ECOPACK specifications are available at: [www.st.com](http://www.st.com)

**ISOTOP MECHANICAL DATA**

DIM.	mm			inch		
	MIN.	TYP.	MAX.	MIN.	TYP.	MAX.
A	11.8		12.2	0.466		0.480
B	8.9		9.1	0.350		0.358
C	1.95		2.05	0.076		0.080
D	0.75		0.85	0.029		0.033
E	12.6		12.8	0.496		0.503
F	25.15		25.5	0.990		1.003
G	31.5		31.7	1.240		1.248
H	4			0.157		
J	4.1		4.3	0.161		0.169
K	14.9		15.1	0.586		0.594
L	30.1		30.3	1.185		1.193
M	37.8		38.2	1.488		1.503
N	4			0.157		
O	7.8		8.2	0.307		0.322

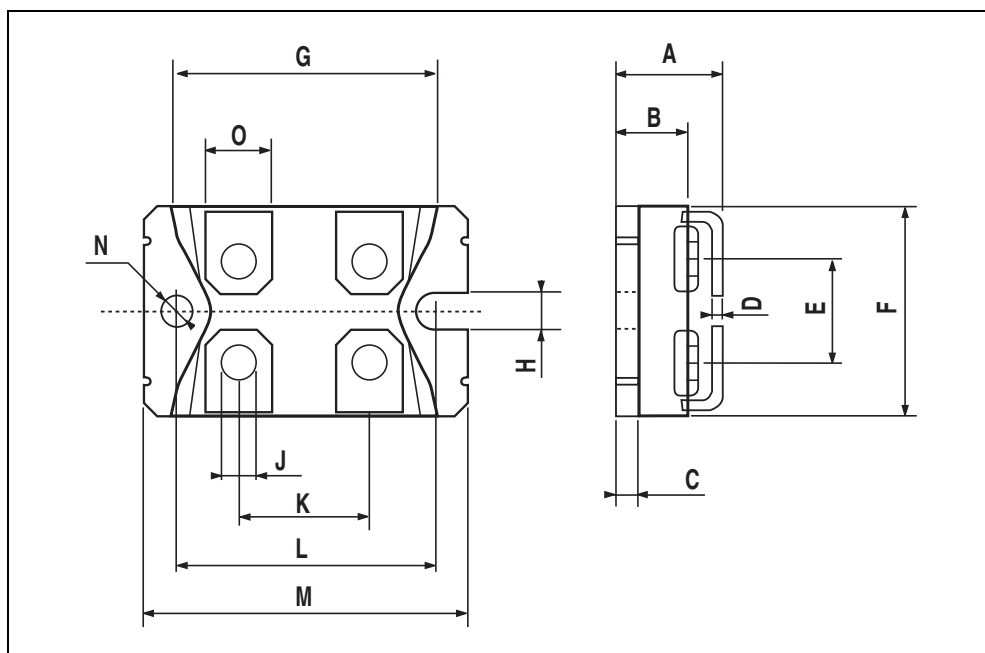

## 5 Revision History

Table 9. Revision history

Date	Revision	Changes
07-May-2006	1	First release
24-Jul-2007	2	New <a href="#">Figure 1: Internal schematic diagram</a>

**Please Read Carefully:**

Information in this document is provided solely in connection with ST products. STMicroelectronics NV and its subsidiaries ("ST") reserve the right to make changes, corrections, modifications or improvements, to this document, and the products and services described herein at any time, without notice.

All ST products are sold pursuant to ST's terms and conditions of sale.

Purchasers are solely responsible for the choice, selection and use of the ST products and services described herein, and ST assumes no liability whatsoever relating to the choice, selection or use of the ST products and services described herein.

No license, express or implied, by estoppel or otherwise, to any intellectual property rights is granted under this document. If any part of this document refers to any third party products or services it shall not be deemed a license grant by ST for the use of such third party products or services, or any intellectual property contained therein or considered as a warranty covering the use in any manner whatsoever of such third party products or services or any intellectual property contained therein.

**UNLESS OTHERWISE SET FORTH IN ST'S TERMS AND CONDITIONS OF SALE ST DISCLAIMS ANY EXPRESS OR IMPLIED WARRANTY WITH RESPECT TO THE USE AND/OR SALE OF ST PRODUCTS INCLUDING WITHOUT LIMITATION IMPLIED WARRANTIES OF MERCHANTABILITY, FITNESS FOR A PARTICULAR PURPOSE (AND THEIR EQUIVALENTS UNDER THE LAWS OF ANY JURISDICTION), OR INFRINGEMENT OF ANY PATENT, COPYRIGHT OR OTHER INTELLECTUAL PROPERTY RIGHT.**

**UNLESS EXPRESSLY APPROVED IN WRITING BY AN AUTHORIZED ST REPRESENTATIVE, ST PRODUCTS ARE NOT RECOMMENDED, AUTHORIZED OR WARRANTED FOR USE IN MILITARY, AIR CRAFT, SPACE, LIFE SAVING, OR LIFE SUSTAINING APPLICATIONS, NOR IN PRODUCTS OR SYSTEMS WHERE FAILURE OR MALFUNCTION MAY RESULT IN PERSONAL INJURY, DEATH, OR SEVERE PROPERTY OR ENVIRONMENTAL DAMAGE. ST PRODUCTS WHICH ARE NOT SPECIFIED AS "AUTOMOTIVE GRADE" MAY ONLY BE USED IN AUTOMOTIVE APPLICATIONS AT USER'S OWN RISK.**

Resale of ST products with provisions different from the statements and/or technical features set forth in this document shall immediately void any warranty granted by ST for the ST product or service described herein and shall not create or extend in any manner whatsoever, any liability of ST.

ST and the ST logo are trademarks or registered trademarks of ST in various countries.

Information in this document supersedes and replaces all information previously supplied.

The ST logo is a registered trademark of STMicroelectronics. All other names are the property of their respective owners.

© 2007 STMicroelectronics - All rights reserved

STMicroelectronics group of companies

Australia - Belgium - Brazil - Canada - China - Czech Republic - Finland - France - Germany - Hong Kong - India - Israel - Italy - Japan - Malaysia - Malta - Morocco - Singapore - Spain - Sweden - Switzerland - United Kingdom - United States of America

[www.st.com](http://www.st.com)