



# STGP7NB60FD - STGB7NB60FD

N-CHANNEL 7A - 600V TO-220 / D<sup>2</sup>PAK

PowerMESH™ IGBT

TYPE	V <sub>CES</sub>	V <sub>CE(sat)</sub> (Max) @25°C	I <sub>C</sub> @100°C
STGP7NB60FD	600 V	< 2.4 V	7 A
STGB7NB60FD	600 V	< 2.4 V	7 A

- HIGH INPUT IMPEDANCE
- LOW ON-VOLTAGE DROP (V<sub>cesat</sub>)
- OFF LOSSES INCLUDE TAIL CURRENT
- LOW GATE CHARGE
- HIGH CURRENT CAPABILITY
- HIGH FREQUENCY OPERATION
- CO-PACKAGED WITH TURBOSWITCH™ ANTIPARALLEL DIODE

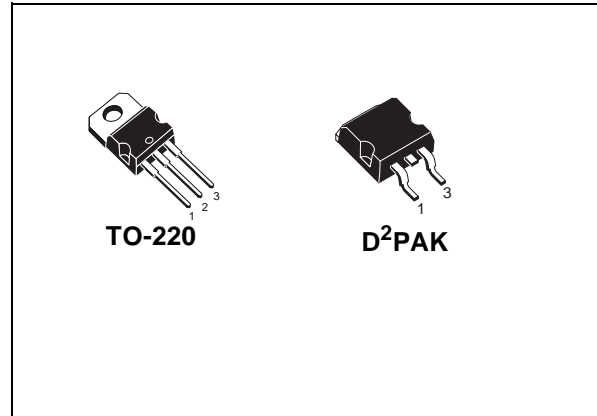

## DESCRIPTION

Using the latest high voltage technology based on a patented strip layout, STMicroelectronics has designed an advanced family of IGBTs, the PowerMESH™ IGBTs, with outstanding performances. The suffix "F" identifies a family optimized to achieve very low switching times for high frequency applications (<40KHZ)

## APPLICATIONS

- MOTOR CONTROLS
- SMPS AND PFC AND BOTH HARD SWITCH AND RESONANT TOPOLOGIES

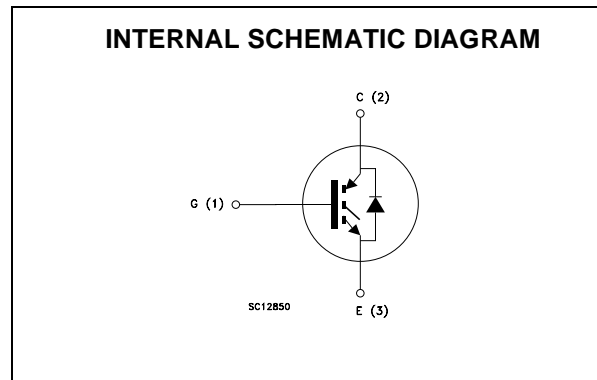

## ORDERING INFORMATION

SALES TYPE	MARKING	PACKAGE	PACKAGING
STGP7NB60FD	GP7NB60FD	TO-220	TUBE
STGB7NB60FDT4	GB7NB60FD	D <sup>2</sup> PAK	TAPE & REEL

## STGP7NB60FD - STGB7NB60FD

### ABSOLUTE MAXIMUM RATINGS

Symbol	Parameter	Value	Unit
$V_{CES}$	Collector-Emitter Voltage ( $V_{GS} = 0$ )	600	V
$V_{GE}$	Gate-Emitter Voltage	$\pm 20$	V
$I_C$	Collector Current (continuous) at $T_C = 25^\circ\text{C}$	14	A
$I_C$	Collector Current (continuous) at $T_C = 100^\circ\text{C}$	7	A
$I_{CM}$ (■)	Collector Current (pulsed)	56	A
$P_{TOT}$	Total Dissipation at $T_C = 25^\circ\text{C}$	80	W
	Derating Factor	0.64	W/°C
$T_{stg}$	Storage Temperature	- 55 to 150	°C
$T_j$	Max. Operating Junction Temperature	150	°C

(■) Pulse width limited by safe operating area

### THERMAL DATA

Rthj-case	Thermal Resistance Junction-case Max	1.56	°C/W
Rthj-amb	Thermal Resistance Junction-ambient Max	62.5	°C/W

### ELECTRICAL CHARACTERISTICS ( $T_{CASE} = 25^\circ\text{C}$ UNLESS OTHERWISE SPECIFIED)

OFF

Symbol	Parameter	Test Conditions	Min.	Typ.	Max.	Unit
$V_{BR(CES)}$	Collector-Emitter Breakdown Voltage	$I_C = 250\ \mu\text{A}$ , $V_{GE} = 0$	600			V
$I_{CES}$	Collector cut-off ( $V_{GE} = 0$ )	$V_{CE} = \text{Max Rating}$ , $T_C = 25^\circ\text{C}$ $V_{CE} = \text{Max Rating}$ , $T_C = 125^\circ\text{C}$			50 100	$\mu\text{A}$ $\mu\text{A}$
$I_{GES}$	Gate-Emitter Leakage Current ( $V_{CE} = 0$ )	$V_{GE} = \pm 20\text{V}$ , $V_{CE} = 0$			$\pm 100$	nA

ON (1)

Symbol	Parameter	Test Conditions	Min.	Typ.	Max.	Unit
$V_{GE(th)}$	Gate Threshold Voltage	$V_{CE} = V_{GE}$ , $I_C = 250\ \mu\text{A}$	3		5	V
$V_{CE(sat)}$	Collector-Emitter Saturation Voltage	$V_{GE} = 15\text{V}$ , $I_C = 7\ \text{A}$ $V_{GE} = 15\text{V}$ , $I_C = 7\ \text{A}$ , $T_j = 125^\circ\text{C}$		2.0 1.6	2.4	V V

**ELECTRICAL CHARACTERISTICS (CONTINUED)**  
DYNAMIC

Symbol	Parameter	Test Conditions	Min.	Typ.	Max.	Unit
$g_{fs}$ (1)	Forward Transconductance	$V_{CE} = 25\text{ V}, I_C = 7\text{ A}$		6		S
$C_{ies}$	Input Capacitance	$V_{CE} = 25\text{ V}, f = 1\text{ MHz}, V_{GE} = 0$		540		pF
$C_{oes}$	Output Capacitance			80		pF
$C_{res}$	Reverse Transfer Capacitance			13		pF
$Q_g$ $Q_{ge}$ $Q_{gc}$	Total Gate Charge Gate-Emitter Charge Gate-Collector Charge	$V_{CE} = 480\text{ V}, I_C = 7\text{ A},$ $V_{GE} = 15\text{ V}$		37 4 18	50	nC nC nC
$I_{CL}$	Latching Current	$V_{clamp} = 480\text{ V}$ $T_j = 125^\circ\text{C}, R_G = 10\ \Omega$		28		A

**SWITCHING ON**

Symbol	Parameter	Test Conditions	Min.	Typ.	Max.	Unit
$t_{d(on)}$ $t_r$	Turn-on Delay Time Rise Time	$V_{CC} = 480\text{ V}, I_C = 7\text{ A}, R_G = 10\ \Omega,$ $V_{GE} = 15\text{ V}$		17 6		ns ns
$(di/dt)_{on}$ $E_{on}$	Turn-on Current Slope Turn-on Switching Losses	$V_{CC} = 480\text{ V}, I_C = 7\text{ A}, R_G = 10\ \Omega$ $V_{GE} = 15\text{ V}, T_j = 125^\circ\text{C}$		890 59		A/ $\mu\text{s}$ $\mu\text{J}$

**SWITCHING OFF**

Symbol	Parameter	Test Conditions	Min.	Typ.	Max.	Unit	
$t_c$ $t_r(V_{off})$ $t_{d(off)}$ $t_f$	Cross-over Time Off Voltage Rise Time Delay Time Fall Time	$V_{CC} = 480\text{ V}, I_C = 7\text{ A},$ $R_G = 10\ \Omega, V_{GE} = 15\text{ V}$		190 45 107 140		ns ns ns ns	
$E_{off(**)}$ $E_{ts}$	Turn-off Switching Loss Total Switching Loss			240 300		$\mu\text{J}$ $\mu\text{J}$	
$t_c$ $t_r(V_{off})$ $t_{d(off)}$ $t_f$	Cross-over Time Off Voltage Rise Time Delay Time Fall Time		$V_{CC} = 480\text{ V}, I_C = 7\text{ A},$ $R_G = 10\ \Omega, V_{GE} = 15\text{ V}$ $T_j = 125^\circ\text{C}$		410 195 204 650		ns ns ns ns
$E_{off(**)}$ $E_{ts}$	Turn-off Switching Loss Total Switching Loss				565 625		$\mu\text{J}$ $\mu\text{J}$

**COLLECTOR-EMITTER DIODE**

Symbol	Parameter	Test Conditions	Min.	Typ.	Max.	Unit
$I_f$ $I_{fm}$	Forward Current Forward Current pulsed				7 56	A A
$V_f$	Forward On-Voltage	$I_f = 3.5\text{ A}$ $I_f = 3.5\text{ A}, T_j = 125^\circ\text{C}$		1.4 1.1	1.9	V V
$t_{rr}$ $Q_{rr}$ $I_{rrm}$	Reverse Recovery Time Reverse Recovery Charge Reverse Recovery Current	$I_f = 7\text{ A}, V_R = 40\text{ V},$ $T_j = 125^\circ\text{C}, di/dt = 100\text{ A}/\mu\text{s}$		50 70 2.7		ns nC A

Note: 1. Pulsed: Pulse duration = 300  $\mu\text{s}$ , duty cycle 1.5 %.  
2. Pulse width limited by max. junction temperature.  
(\*\*)Losses include Also the Tail (Jedec Standardization)

# STGP7NB60FD - STGB7NB60FD

## Output Characteristics

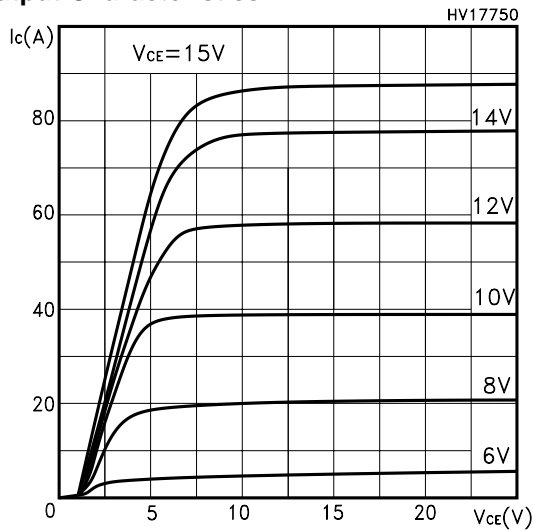

## Transfer Characteristics

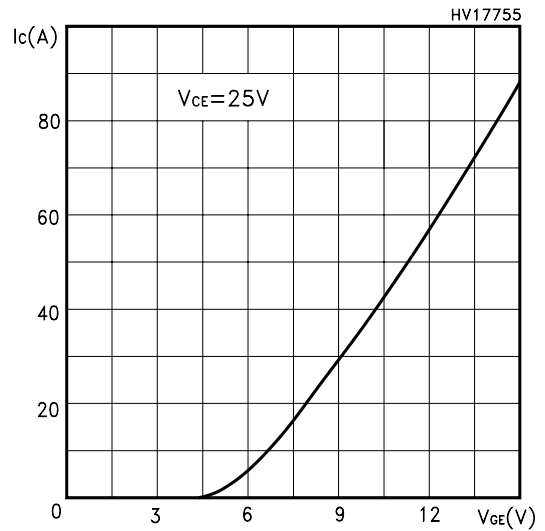

## Transconductance

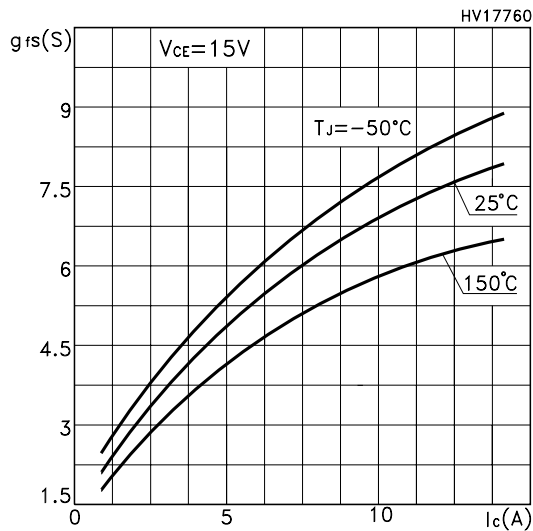

## Normalized Collector-Emitter On Voltage vs Temp.

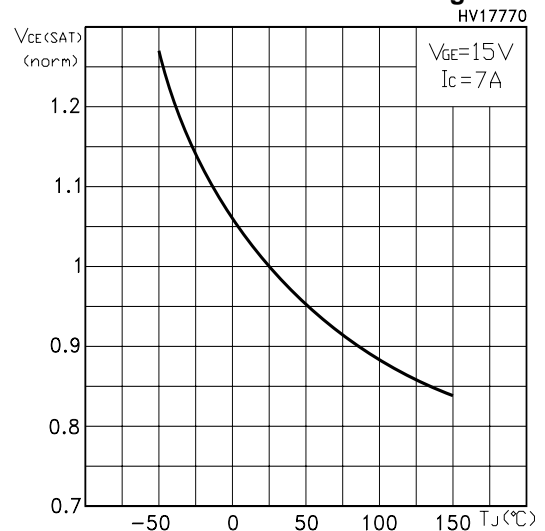

## Collector-Emitter On Voltage vs Collector Current

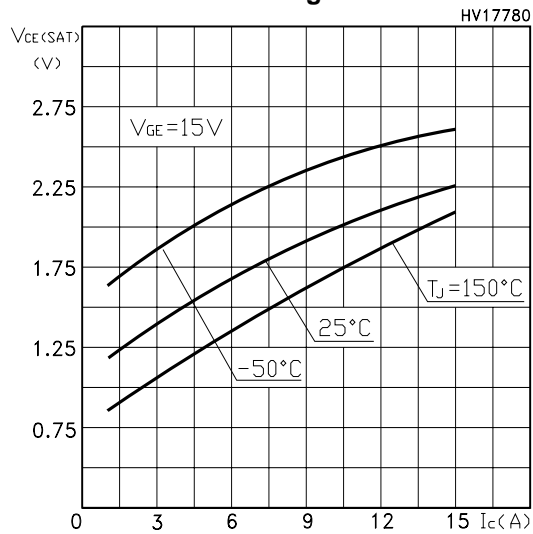

## Gate Threshold vs Temperature

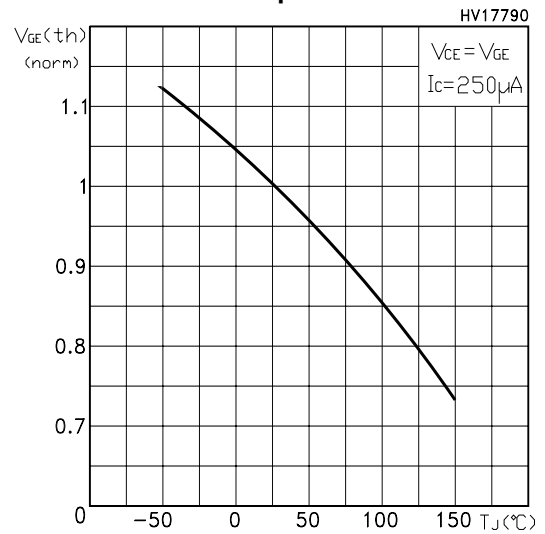

Normalized Breakdown Voltage vs Temperature

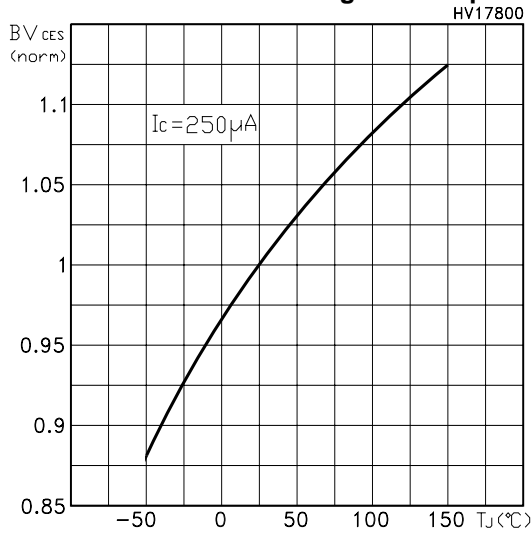

Capacitance Variations

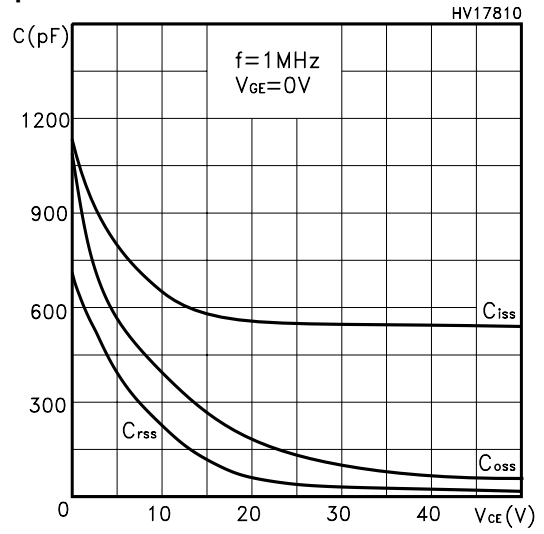

Gate Charge vs Gate-Emitter Voltage

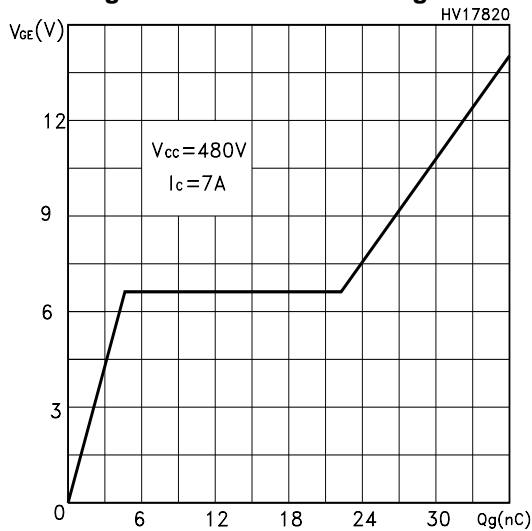

Total Switching Losses vs Gate Resistance

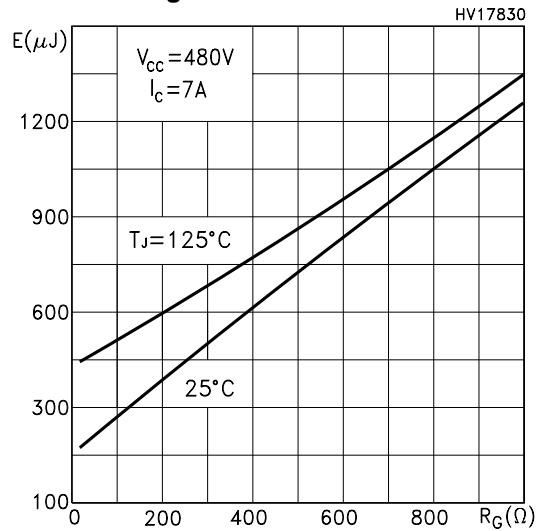

Total Switching Losses vs Temperature

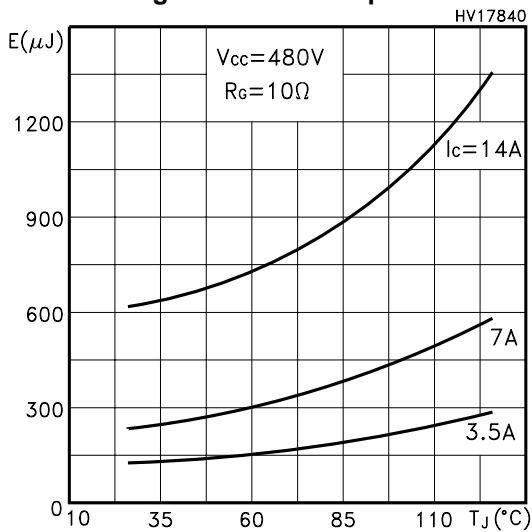

Total Switching Losses vs Collector Current

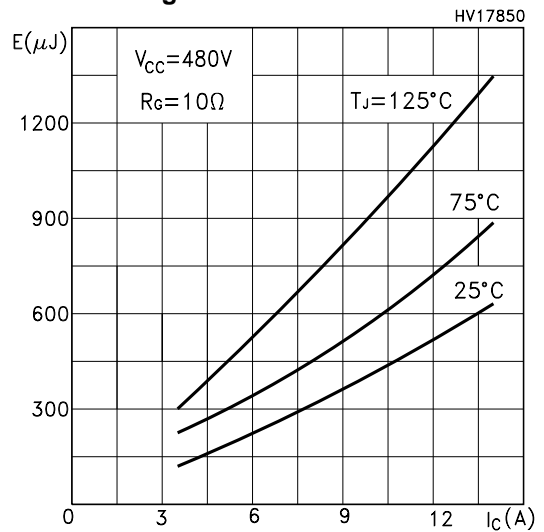

Thermal Impedance for TO-220/D<sup>2</sup>PAK

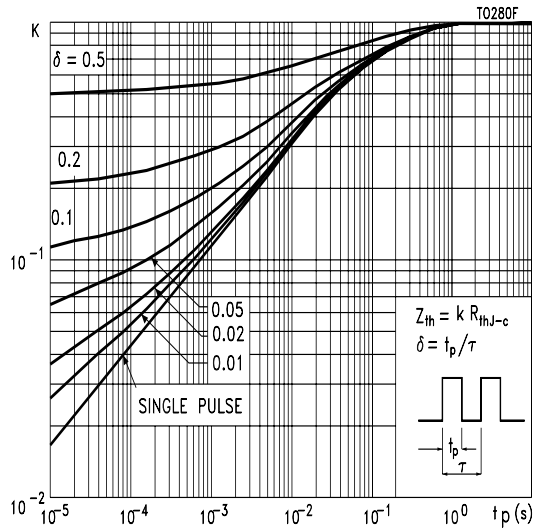

Turn-Off SOA

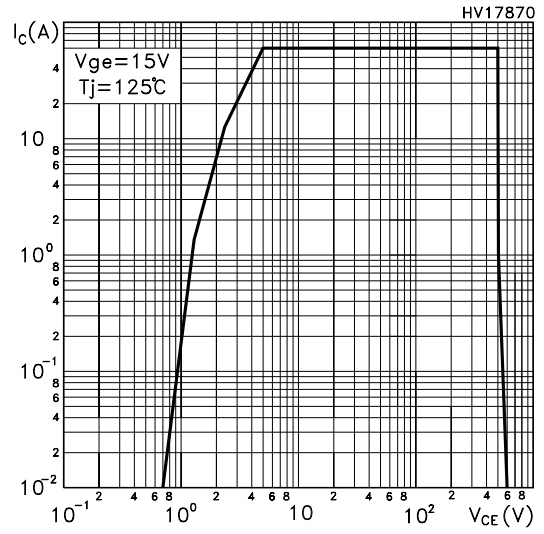

Emitter-Collector Diode Characteristics

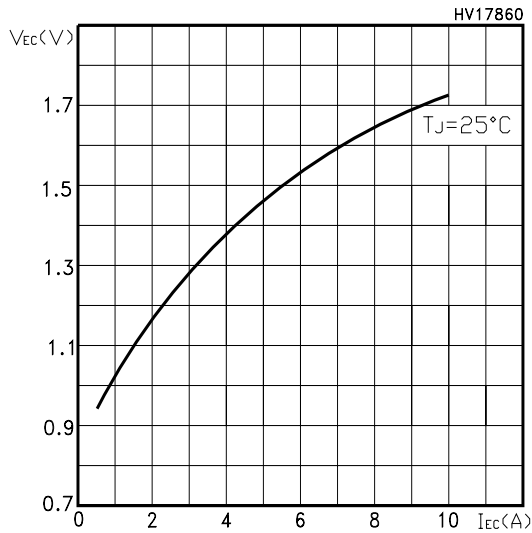



**TO-220 MECHANICAL DATA**

DIM.	mm.			inch		
	MIN.	TYP.	MAX.	MIN.	TYP.	MAX.
A	4.40		4.60	0.173		0.181
b	0.61		0.88	0.024		0.034
b1	1.15		1.70	0.045		0.066
c	0.49		0.70	0.019		0.027
D	15.25		15.75	0.60		0.620
E	10		10.40	0.393		0.409
e	2.40		2.70	0.094		0.106
e1	4.95		5.15	0.194		0.202
F	1.23		1.32	0.048		0.052
H1	6.20		6.60	0.244		0.256
J1	2.40		2.72	0.094		0.107
L	13		14	0.511		0.551
L1	3.50		3.93	0.137		0.154
L20		16.40			0.645	
L30		28.90			1.137	
øP	3.75		3.85	0.147		0.151
Q	2.65		2.95	0.104		0.116

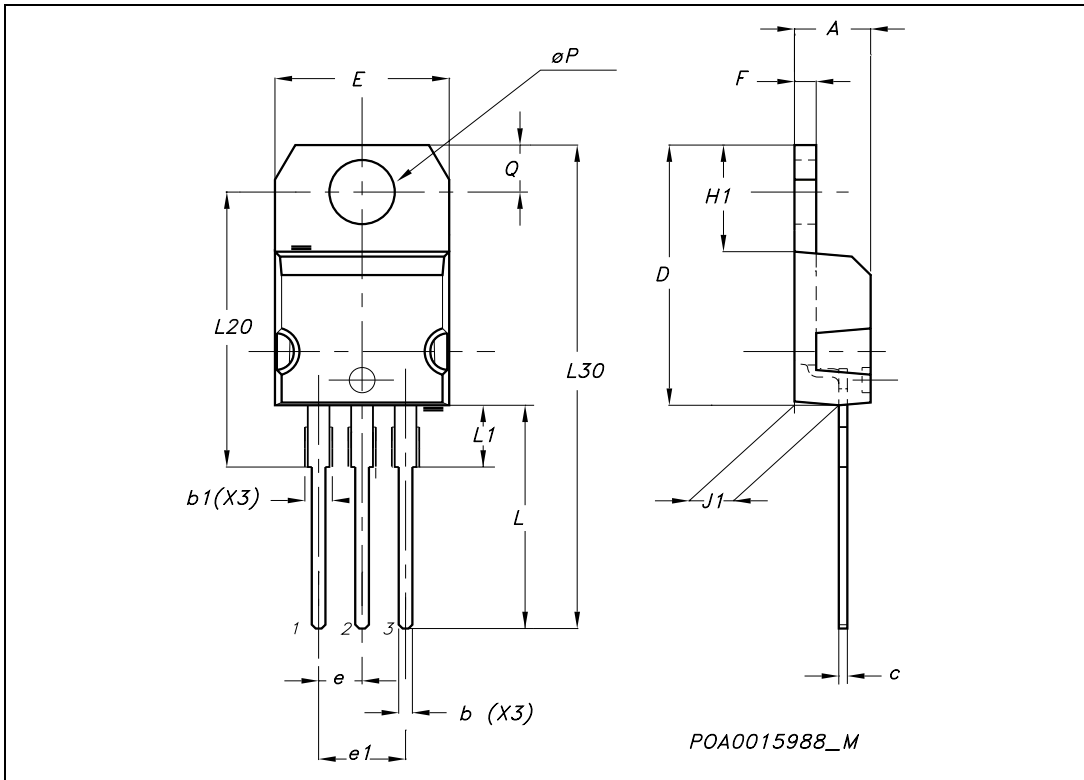



**D<sup>2</sup>PAK MECHANICAL DATA**

DIM.	mm.			inch		
	MIN.	TYP	MAX.	MIN.	TYP.	MAX.
A	4.4		4.6	0.173		0.181
A1	2.49		2.69	0.098		0.106
A2	0.03		0.23	0.001		0.009
B	0.7		0.93	0.027		0.036
B2	1.14		1.7	0.044		0.067
C	0.45		0.6	0.017		0.023
C2	1.23		1.36	0.048		0.053
D	8.95		9.35	0.352		0.368
D1		8			0.315	
E	10		10.4	0.393		
E1		8.5			0.334	
G	4.88		5.28	0.192		0.208
L	15		15.85	0.590		0.625
L2	1.27		1.4	0.050		0.055
L3	1.4		1.75	0.055		0.068
M	2.4		3.2	0.094		0.126
R		0.4			0.015	
V2	0°		4°			

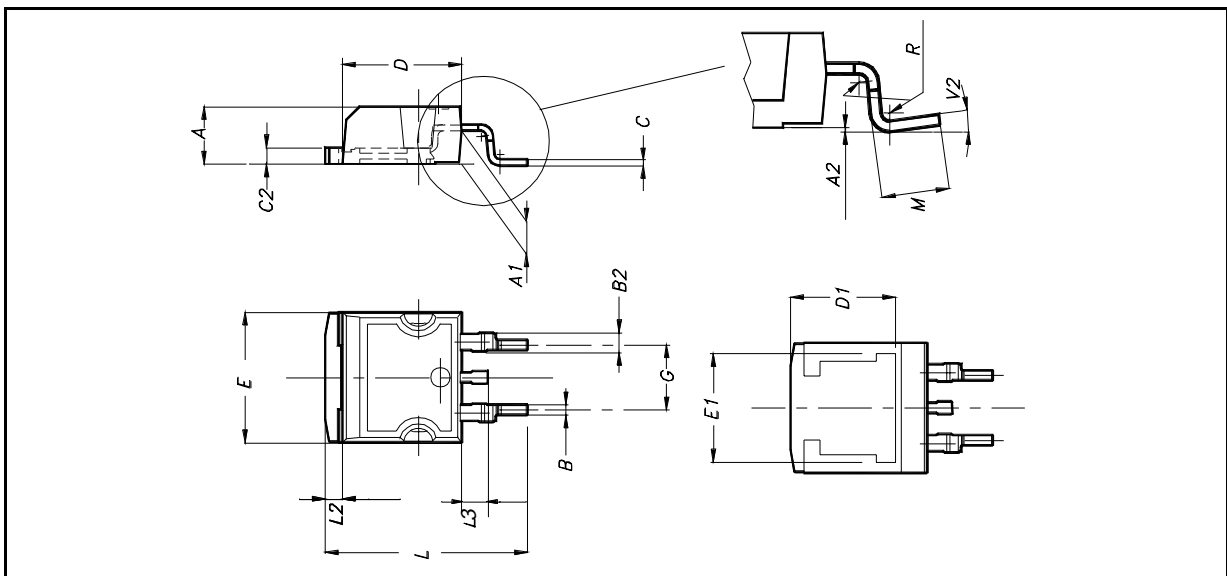

**D<sup>2</sup>PAK FOOTPRINT**

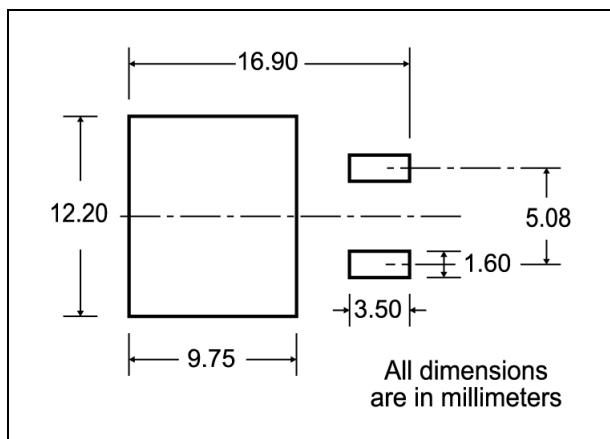

**TUBE SHIPMENT (no suffix)\***

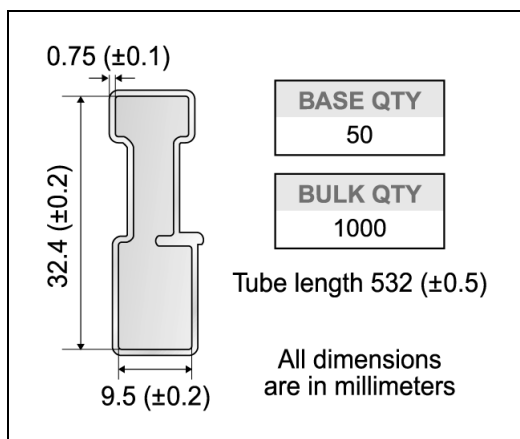

**TAPE AND REEL SHIPMENT (suffix "T4")\***

40 mm min. Access hole at slot location

Full radius

Tape slot in core for tape start 2.5mm min. width

G measured at hub

TAPE MECHANICAL DATA

DIM.	mm		inch	
	MIN.	MAX.	MIN.	MAX.
A0	10.5	10.7	0.413	0.421
B0	15.7	15.9	0.618	0.626
D	1.5	1.6	0.059	0.063
D1	1.59	1.61	0.062	0.063
E	1.65	1.85	0.065	0.073
F	11.4	11.6	0.449	0.456
K0	4.8	5.0	0.189	0.197
P0	3.9	4.1	0.153	0.161
P1	11.9	12.1	0.468	0.476
P2	1.9	2.1	0.075	0.082
R	50		1.574	
T	0.25	0.35	0.0098	0.0137
W	23.7	24.3	0.933	0.956

REEL MECHANICAL DATA

DIM.	mm		inch	
	MIN.	MAX.	MIN.	MAX.
A		330		12.992
B	1.5		0.059	
C	12.8	13.2	0.504	0.520
D	20.2		0.795	
G	24.4	26.4	0.960	1.039
N	100		3.937	
T		30.4		1.197

BASE QTY: 1000      BULK QTY: 1000

10 pitches cumulative tolerance on tape +/- 0.2 mm

User Direction of Feed

Center line of cavity

TRL

FEED DIRECTION

Bending radius R min.

\* on sales type

Information furnished is believed to be accurate and reliable. However, STMicroelectronics assumes no responsibility for the consequences of use of such information nor for any infringement of patents or other rights of third parties which may result from its use. No license is granted by implication or otherwise under any patent or patent rights of STMicroelectronics. Specifications mentioned in this publication are subject to change without notice. This publication supersedes and replaces all information previously supplied. STMicroelectronics products are not authorized for use as critical components in life support devices or systems without express written approval of STMicroelectronics.

© The ST logo is a registered trademark of STMicroelectronics

© 2003 STMicroelectronics - Printed in Italy - All Rights Reserved  
STMicroelectronics GROUP OF COMPANIES

Australia - Brazil - Canada - China - Finland - France - Germany - Hong Kong - India - Israel - Italy - Japan - Malaysia - Malta - Morocco  
Singapore - Spain - Sweden - Switzerland - United Kingdom - United States.

© <http://www.st.com>