

**STK4040V**

## AF Power Amplifier (Split Power Supply) (70W min, THD = 0.08%)

### Features

- Small-sized package permitting audio sets to be made slimmer (up to 70W)
- The STK4024Vseries are available for output 20W to 100W (200W) and are pin-compatible. (120W to 200W : 18 pins)
- Facilitates thermal design of slim stereo sets.
- Distortion 0.08% due to current mirror circuit
- Possible to design electronic supplementary circuits (pop noise muting at the time of power ON/OFF, load short protector, thermal shutdown)

### Package Dimensions

unit: mm

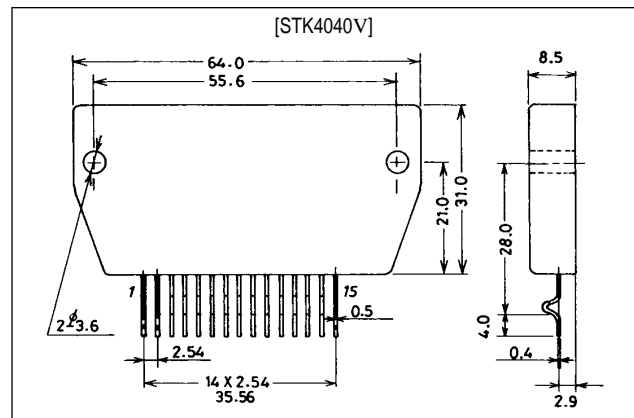
**4062**

### Specifications

**Maximum Ratings** at  $T_a = 25^\circ\text{C}$

Parameter	Symbol	Conditions	Ratings	Unit
Maximum supply voltage	$V_{CC \text{ max}}$		$\pm 62$	V
Thermal resistance	$\theta_{j-c}$		1.4	$^\circ\text{C/W}$
Junction Temperature	$T_j$		150	$^\circ\text{C}$
Operating substrate temperature	$T_c$		125	$^\circ\text{C}$
Storage temperature	$T_{stg}$		$-30$ to $+125$	$^\circ\text{C}$
Available time for load short-circuit	$t_s^*1$	$V_{CC} = \pm 42\text{V}$ , $R_L = 8\Omega$ , $f = 50\text{Hz}$ , $P_o = 70\text{W}$	1	s

**Recommended Operating Conditions** at  $T_a = 25^\circ\text{C}$

Parameter	Symbol	Conditions	Ratings	Unit
Recommended supply voltage	$V_{CC}$		$\pm 42$	V
Load resistance	$R_L$		8	$\Omega$

## STK4040V

**Operating Characteristics** at  $T_a = 25^\circ\text{C}$ ,  $V_{CC} = \pm 42\text{V}$ ,  $R_L = 8\Omega$ ,  $V_G = 40\text{dB}$ ,  $R_g = 600\Omega$ ,  
 100kHz LPF ON,  $R_L$  : noninductive load

Parameter	Symbol	Conditions	min	typ	max	Unit
Quiescent current	$I_{CCQ}$	$V_{CC} = \pm 50.5\text{V}$	15		120	mA
Output power	$P_o$ (1)	THD = 0.08%, $f = 20\text{Hz to } 20\text{kHz}$	70			W
	$P_o$ (2)	$V_{CC} = \pm 36\text{V}$ , THD = 0.2%, $R_L = 4\Omega$ , $f = 1\text{kHz}$	70			W
Total harmonic distortion	THD	$P_o = 1.0\text{W}$ , $f = 1\text{kHz}$			0.08	%
Frequency response	$f_L, f_H$	$P_o = 1.0\text{W}$ , $+0_{-3}$ dB		20 to 50k		Hz
Input impedance	$r_i$	$P_o = 1.0\text{W}$ , $f = 1\text{kHz}$		55		$k\Omega$
Output noise voltage	$V_{NO} * 2$	$V_{CC} = \pm 50.5\text{V}$ , $R_g = 10k\Omega$			1.2	mVrms
Neutral voltage	$V_N$	$V_{CC} = \pm 50.5\text{V}$	-70	0	+70	mV

Notes. For power supply at the time of test, use a constant-voltage power supply unless otherwise specified.

\*1 For measurement of the available time for load short-circuit and output noise voltage, use the specified transformer power supply shown right.

\*2 The output noise voltage is represented by the peak value on rms scale (VTVM) of average value indicating type. The noise voltage waveform includes no flicker noise.

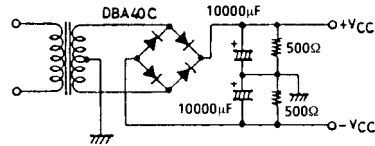

Specified Transformer Power Supply  
(Equivalent to MG-200)

### Equivalent Circuit

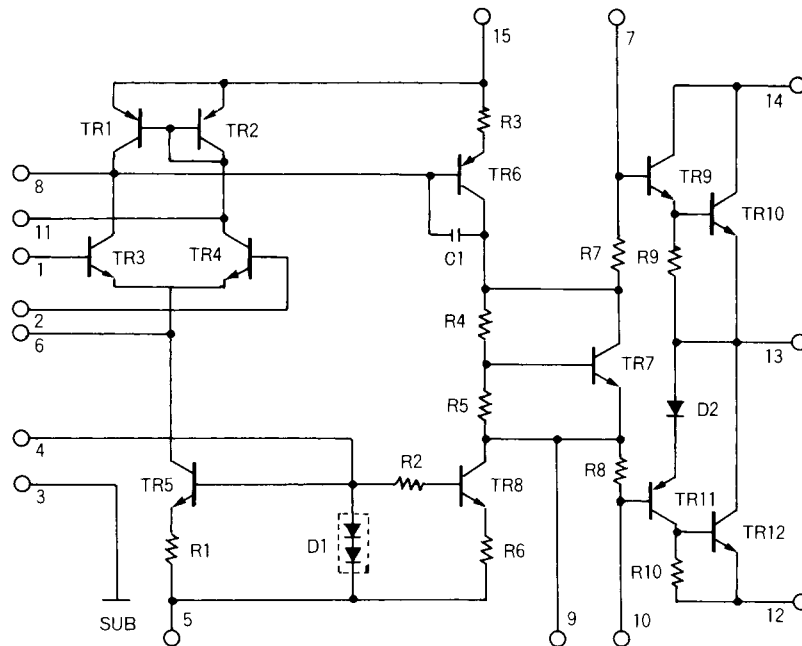

# STK4040V

## Sample Application Circuit: 70W min Single-Channel AF Power Amplifier

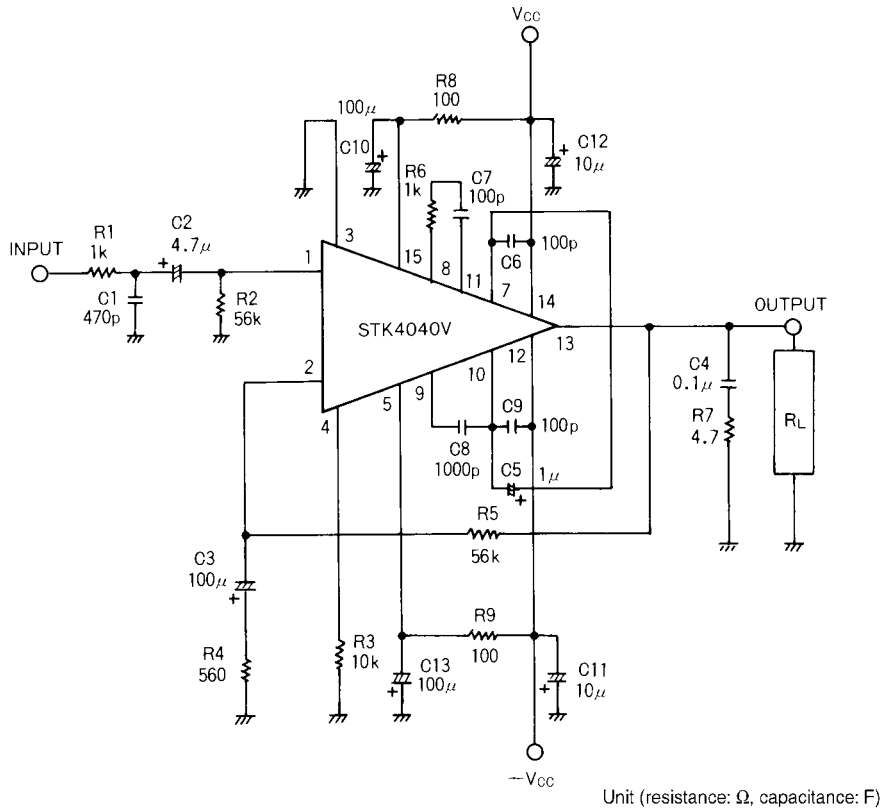

## Sample Printed Circuit Pattern for Application Circuit (Cu-foiled side)

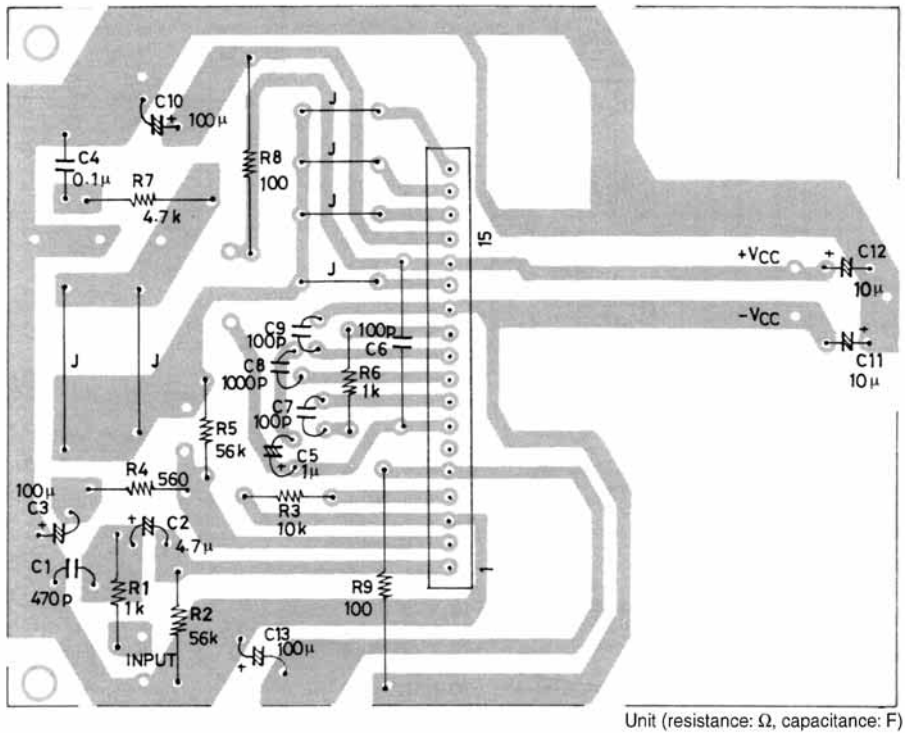

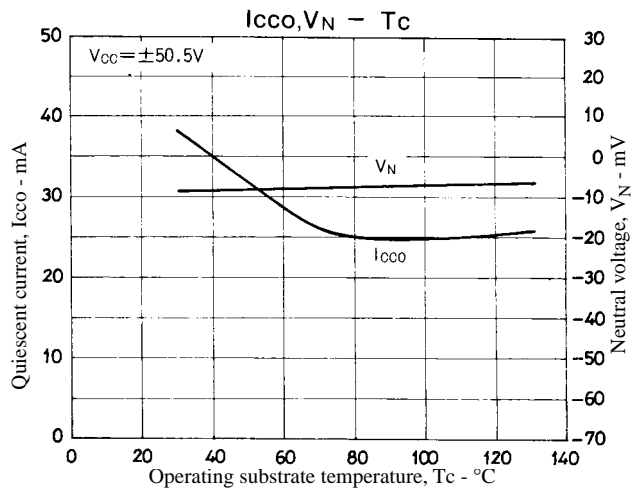
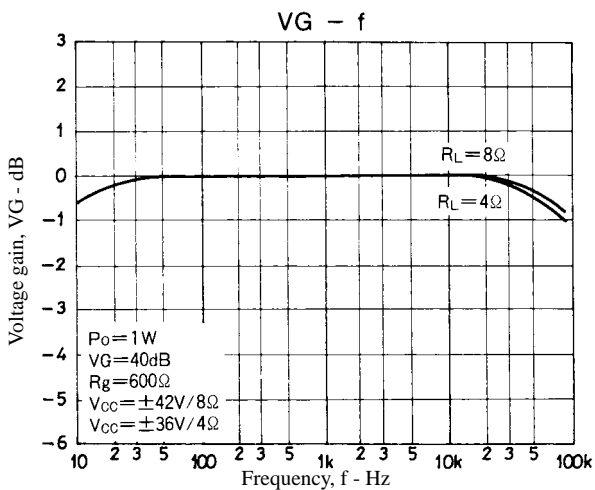
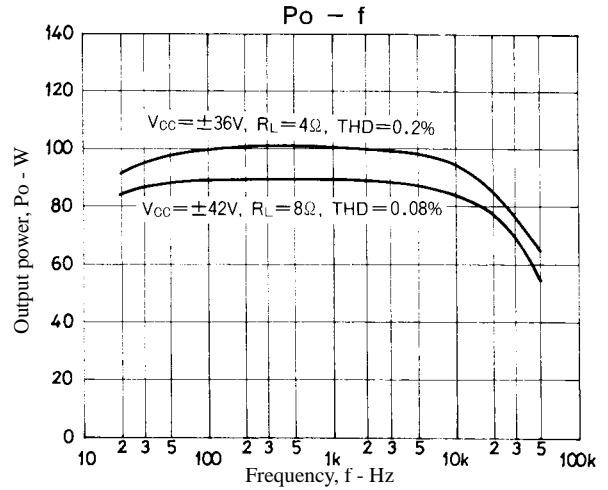
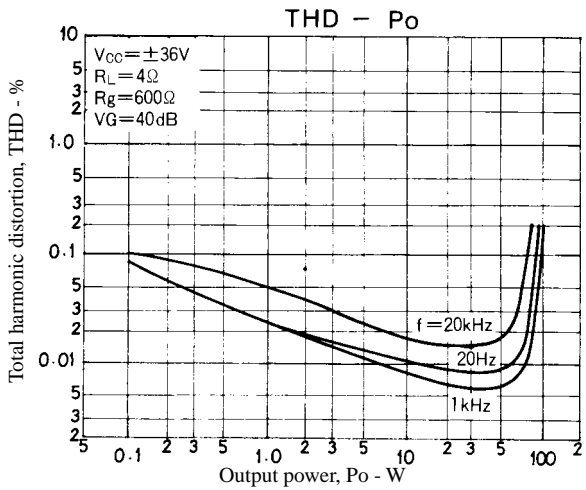
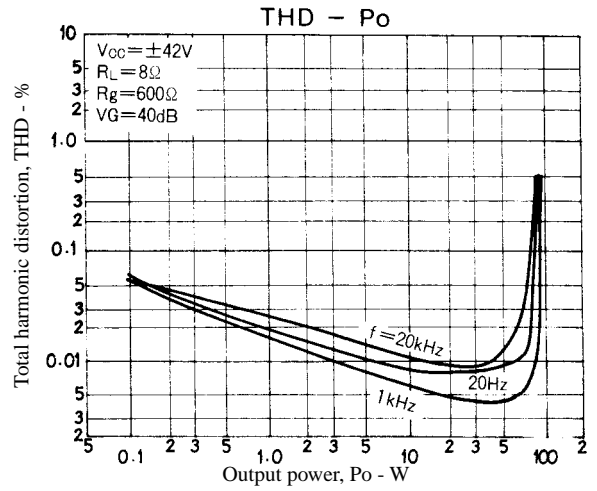
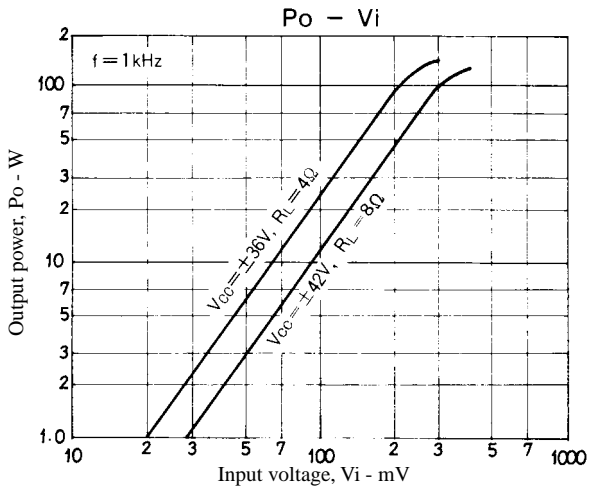

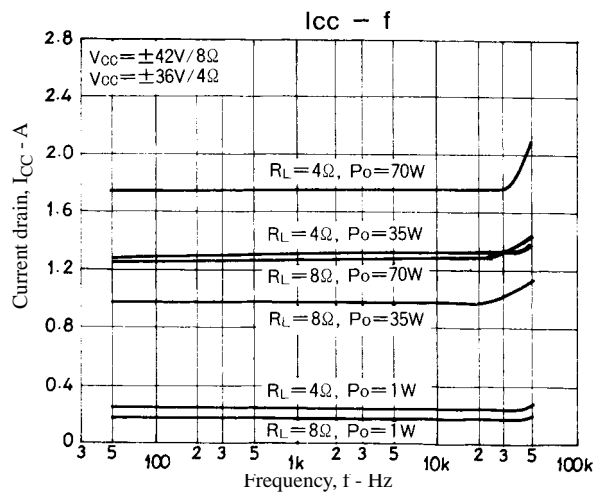
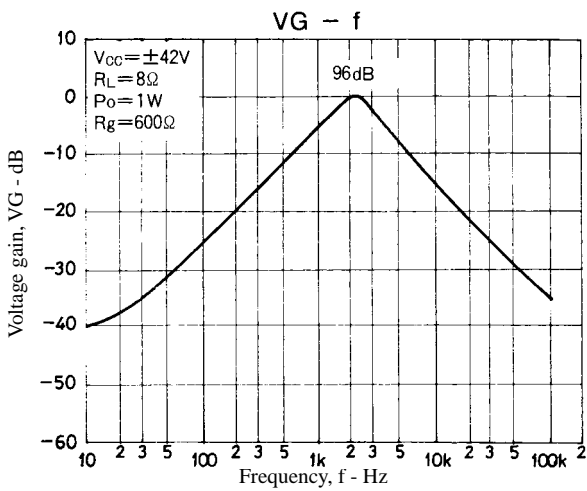
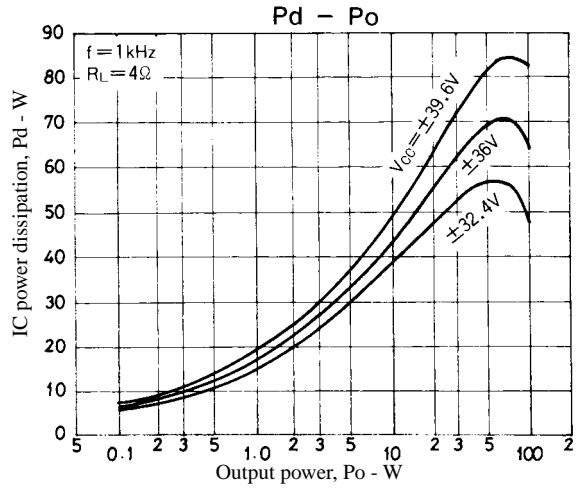
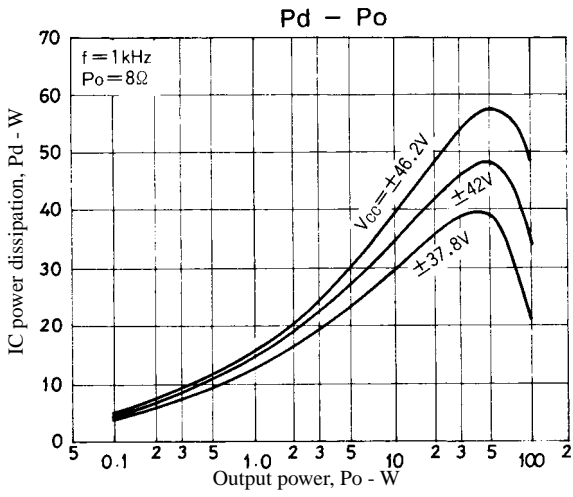
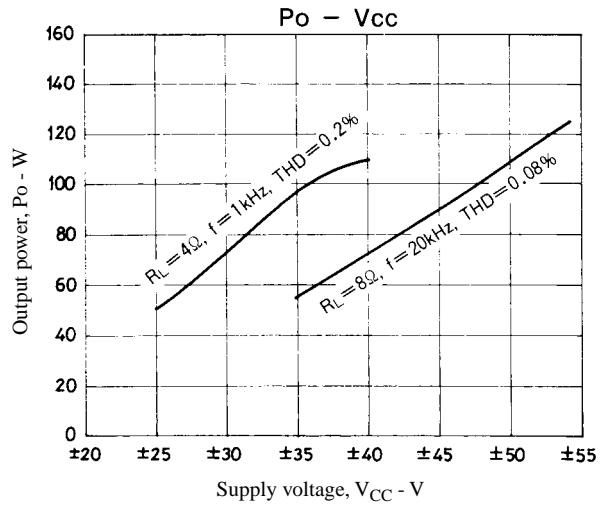
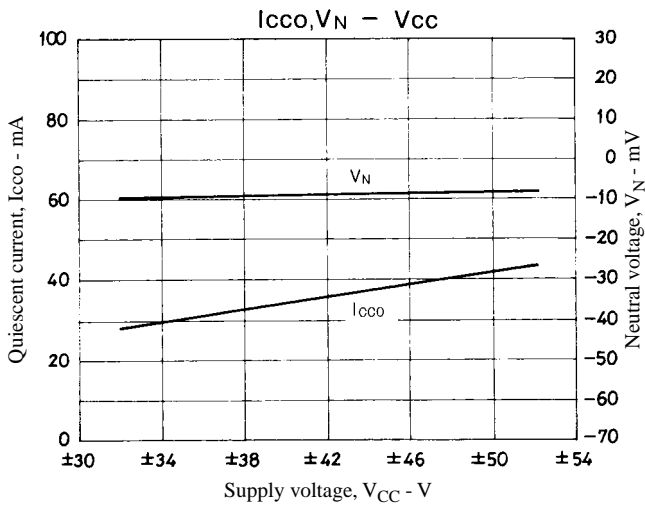

# STK4040V

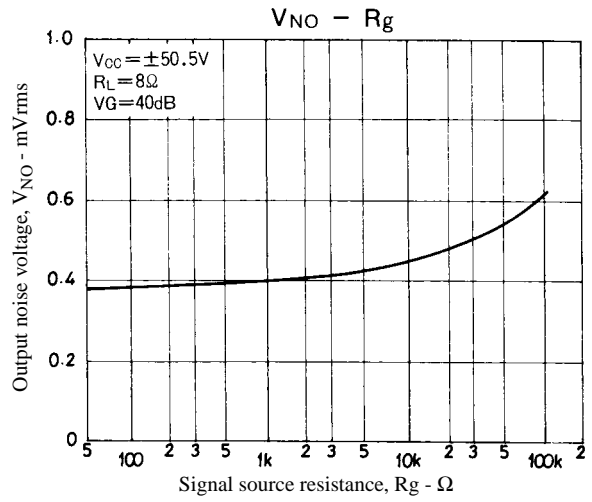
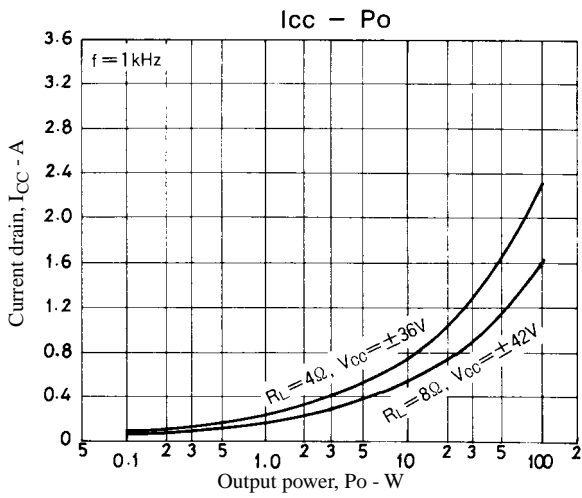

## Description of External Parts

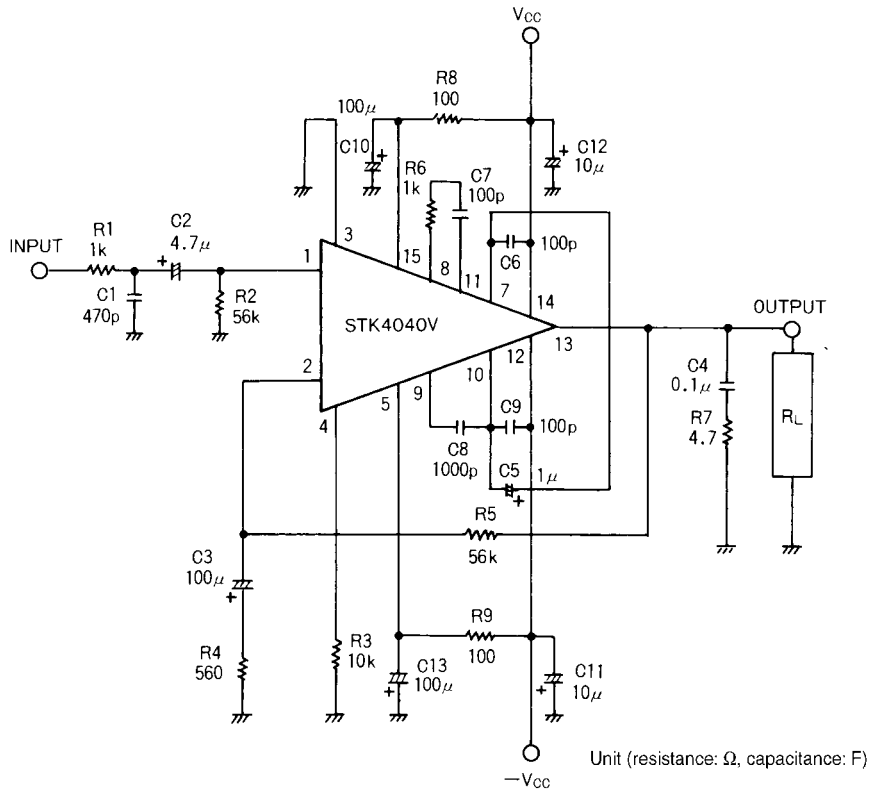

## STK4040V

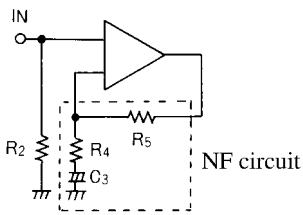
R1, C1	<p>Input filter circuit</p> <ul style="list-style-type: none"> <li>Used to reduce noise at high frequencies.</li> </ul>
C2	<p>Input coupling capacitor</p> <ul style="list-style-type: none"> <li>Used to block DC current. When the reactance of the capacitor increases at low frequencies, the dependence of 1/f noise on signal source resistance causes the output noise to worsen. It is better to decrease the reactance.</li> </ul>
R2	<p>Input bias resistor</p> <ul style="list-style-type: none"> <li>Used to bias the input pin to zero.</li> <li>Affects <math>V_N</math> stability. (See NF circuit.)</li> <li>Because of differential input, this resistor fixes the input resistance practically.</li> </ul>
R4, R5 C3 (R2)	<p>NFB circuit (AC NF circuit). It is desirable that the error of the resistor value is 1% or less.</p> <div style="display: flex; align-items: center; justify-content: center;">  <div style="margin-left: 20px;"> <p>C3 : Capacitor for AC NF R4, R5 : Used to set VG</p> </div> </div> <ul style="list-style-type: none"> <li>VG setting obtained by using R4, R5</li> </ul> $\log 20 \cdot \frac{R_5}{R_4} \quad 40\text{dB is recommended.}$ <ul style="list-style-type: none"> <li>Low cutoff frequency setting obtained by using, R4, C3.</li> </ul> $f_L = \frac{1}{2\pi \cdot R_4 \cdot C_3} [\text{Hz}]$ <p>To change VG setting, it is desirable to change R4. In this case, the low cutoff frequency setting needs to be rechecked. When VG setting is changed by changing R5, R5 must be made equal to R2 to ensure <math>V_N</math> balance. If the resistor value is increased more than the existing value, it may be hard to ensure <math>V_N</math> balance and the temperature characteristic of <math>V_N</math> may be also deteriorated.</p>
R3	Differential constant-current bias resistor
R6, R7	Used for oscillation blocking and phase compensation
R7, C4	Used for oscillation blocking and phase compensation (C4 : A polyester film capacitor is recommended.)
C6, C9	Used for oscillation blocking and phase compensation Power amp stage (Must be connected near the pin)    C6 : Power amp on (+) side C9 : Power amp on (-) side
C8	Used for oscillation blocking and phase compensation (Used for oscillation blocking before clip at power amp stage)
C5	Used for oscillation blocking and distortion improvement
R8, C10	Ripple filter circuit on (+) side
R9, C13	Ripple filter circuit on (-) side
C11, C12	<p>Used for oscillation blocking</p> <ul style="list-style-type: none"> <li>Used to decrease the power supply impedance to operate the IC stably. Must be connected near the IC pin. It is desirable to use an electrolytic capacitor.</li> </ul>





In an actual application where a music signal is used, it is impractical to estimate the power dissipation based on the continuous signal as shown above, because too large a heat sink must be used. It is reasonable to estimate the power dissipation as 1/10 Po max. (EIAJ).

That is, Pd = 30.6W at 8Ω, Pd = 38.2W at 4Ω

Thermal resistance θc-a of a heat sink for this IC power dissipation (Pd) is fixed under conditions 1 and 2 shown below.

Condition 1:  $T_C = Pd \times \theta_{c-a} + T_a \leq 125^\circ\text{C}$  ..... (1)  
 where Ta : Specified ambient temperature  
 TC : Operating substrate temperature

Condition 2:  $T_j = Pd \times (\theta_{c-a}) + Pd/2 \times (\theta_{j-c}) + T_a \leq 150^\circ\text{C}$ ..... (2)  
 where Tj : Junction temperature of power transistor

Assuming that the power dissipation is shared equally between the two power transistors, thermal resistance θj-c is 1.4°C/W and

$Pd \times (\theta_{c-a} + 1.4/2) + T_a \leq 150^\circ\text{C}$ ..... (3)

Thermal resistance θc-a of a heat sink must satisfy inequalities (1) and (3).

Figure 3 shows the relation between Pd and θc-a given from (1) and (3) with Ta as a parameter.

[Example] The thermal resistance of a heat sink is obtained when the ambient temperature specified for a stereo amplifier is 50°C.

Assuming VCC = ±42V, RL = 8Ω,  
 VCC = ±36V, RL = 4Ω,

RL = 8Ω : Pd1 = 30.6W at 1/10 Po max.  
 RL = 4Ω : Pd2 = 38.2W at 1/10 Po max.

The thermal resistance of a heat sink is obtained from Figure 3.

RL = 8Ω : θc-a1 = 2.45°C/W

RL = 4Ω : θc-a2 = 1.89°C/W

Tj when a heat sink is used is obtained from (3).

RL = 8Ω : Tj = 146.4°C

RL = 4Ω : Tj = 148.9°C

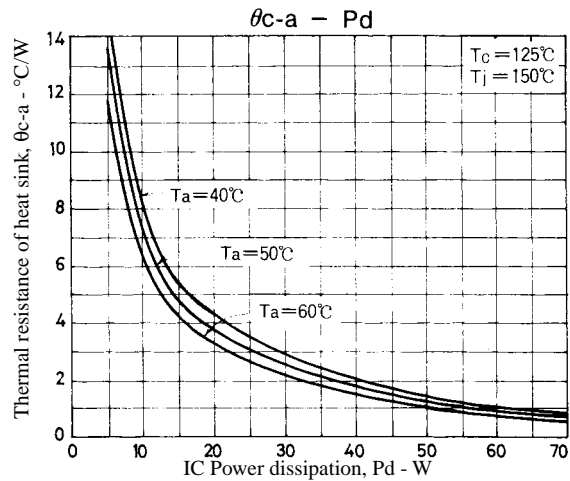

Figure 3. STK4040V θc-a - Pd

This design is based on the use of a constant-voltage regulated power supply. Pd differs when a transformer power supply is used. Redesign must be made based on Pd that suits the regulation of each transformer.

- No products described or contained herein are intended for use in surgical implants, life-support systems, aerospace equipment, nuclear power control systems, vehicles, disaster/crime-prevention equipment and the like, the failure of which may directly or indirectly cause injury, death or property loss.
- Anyone purchasing any products described or contained herein for an above-mentioned use shall:
  - ① Accept full responsibility and indemnify and defend SANYO ELECTRIC CO., LTD., its affiliates, subsidiaries and distributors and all their officers and employees, jointly and severally, against any and all claims and litigation and all damages, cost and expenses associated with such use:
  - ② Not impose any responsibility for any fault or negligence which may be cited in any such claim or litigation on SANYO ELECTRIC CO., LTD., its affiliates, subsidiaries and distributors or any of their officers and employees, jointly or severally.
- Information (including circuit diagrams and circuit parameters) herein is for example only; it is not guaranteed for volume production. SANYO believes information herein is accurate and reliable, but no guarantees are made or implied regarding its use or any infringements of intellectual property rights or other rights of third parties.