

IMST

TENTATIVE

Thick Film Hybrid IC

STK417-000series**2-channel High Efficiency AF Power Amplifier
50W × 2 ~ 100W × 2 (THD=0.4%)**

■ **Function**
2-channel High Efficiency AF Power Amplifier

■ **Application**
Audio use

■ **Feature**

- Low Power consumption
- Built-in switch circuit of Power Supply Voltage
- Built-in thermal detection
- Built-in anti AM noise circuit
- Pin Compatible STK407-000series and STK427-000series

* STK407-000series is Normal AF Power Amplifier

* STK427-000series is Other System High Efficiency AF Power Amplifier

■ **Schedule**

ES 1996.12

MP 1997.6

■ The composition of compatible series

$T_a = 25^\circ\text{C}$, $R_g = 600\ \Omega$, $V_G = 40\ \text{dB}$, R_L (Non-inductive Load)

Item	Condition	Type			
		ST1 917-09C	ST4 917-10C	ST7 917-12C	ST9 917-13C
Max.Voltage VH1	$R_L=6\ \Omega, 8\ \Omega$	$\pm 50.0\text{V}$	$\pm 53.0\text{V}$	$\pm 61.0\text{V}$	$\pm 67.0\text{V}$
Max.Voltage VH2	$R_L=4\ \Omega$	$\pm 40.0\text{V}$	$\pm 42.0\text{V}$	$\pm 46.0\text{V}$	$\pm 48.0\text{V}$
Max.Voltage VL1	$R_L=6\ \Omega, 8\ \Omega$	$\pm 27.5\text{V}$	$\pm 29.0\text{V}$	$\pm 33.5\text{V}$	$\pm 37.0\text{V}$
Max.Voltage VL2	$R_L=4\ \Omega$	$\pm 19.0\text{V}$	$\pm 20.5\text{V}$	$\pm 23.5\text{V}$	$\pm 26.0\text{V}$
Output Power 1 [min.]	$R_L=6\ \Omega$ $f=20\sim 20\text{kHz}$ $\text{THD}=0.4\%$	$P_O= 50\text{W}$ ($V_H=\pm 34.0\text{V}$)	$P_O= 60\text{W}$ ($V_H=\pm 36.0\text{V}$)	$P_O= 80\text{W}$ ($V_H=\pm 42.0\text{V}$)	$P_O= 100\text{W}$ ($V_H=\pm 46.0\text{V}$)
Output Power 2 [typ.]	$R_L=6\ \Omega$ $f=1\text{kHz}$ $\text{THD}=10\%$	$P_O= 75\text{W}$ ($V_H=\pm 31.0\text{V}$)	$P_O= 90\text{W}$ ($V_H=\pm 33.0\text{V}$)	$P_O= 120\text{W}$ ($V_H=\pm 38.0\text{V}$)	$P_O= 150\text{W}$ ($V_H=\pm 42.0\text{V}$)
Output Power 3 [typ.]	$R_L=8\ \Omega$ $f=1\text{kHz}$ $\text{THD}=10\%$	$P_O= 70\text{W}$ ($V_H=\pm 33.0\text{V}$)	$P_O= 80\text{W}$ ($V_H=\pm 35.0\text{V}$)	$P_O= 100\text{W}$ ($V_H=\pm 40.0\text{V}$)	$P_O= 130\text{W}$ ($V_H=\pm 44.0\text{V}$)
Output Power 4 [typ.]	$R_L=4\ \Omega$ $f=1\text{kHz}$ $\text{THD}=10\%$	$P_O= 70\text{W}$ ($V_H=\pm 25.0\text{V}$)	$P_O= 80\text{W}$ ($V_H=\pm 26.5\text{V}$)	$P_O= 100\text{W}$ ($V_H=\pm 30.0\text{V}$)	$P_O= 120\text{W}$ ($V_H=\pm 32.0\text{V}$)
THD 1 [max.]	$R_L=6\ \Omega$ $f=20\sim 20\text{kHz}$ $P_O=1.0\text{W}$	$\text{THD}=0.4\%$ ($V_H=\pm 34.0\text{V}$)	$\text{THD}=0.4\%$ ($V_H=\pm 36.0\text{V}$)	$\text{THD}=0.4\%$ ($V_H=\pm 42.0\text{V}$)	$\text{THD}=0.4\%$ ($V_H=\pm 46.0\text{V}$)
THD 2 [typ.]	$R_L=6, 8\ \Omega$ $f=1\text{kHz}$	$\text{THD}=0.01\%$ ($P_O= 5\text{W}$)	$\text{THD}=0.01\%$ ($P_O= 6\text{W}$)	$\text{THD}=0.01\%$ ($P_O= 8\text{W}$)	$\text{THD}=0.01\%$ ($P_O=10\text{W}$)
THD 3 [typ.]	$R_L=4\ \Omega$ $f=1\text{kHz}$	$\text{THD}=0.04\%$ ($P_O= 5\text{W}$)	$\text{THD}=0.04\%$ ($P_O= 6\text{W}$)	$\text{THD}=0.04\%$ ($P_O= 8\text{W}$)	$\text{THD}=0.04\%$ ($P_O=10\text{W}$)

※ Specifications and information herein are subject to change without notice.

■ Equivalent Block Diagram

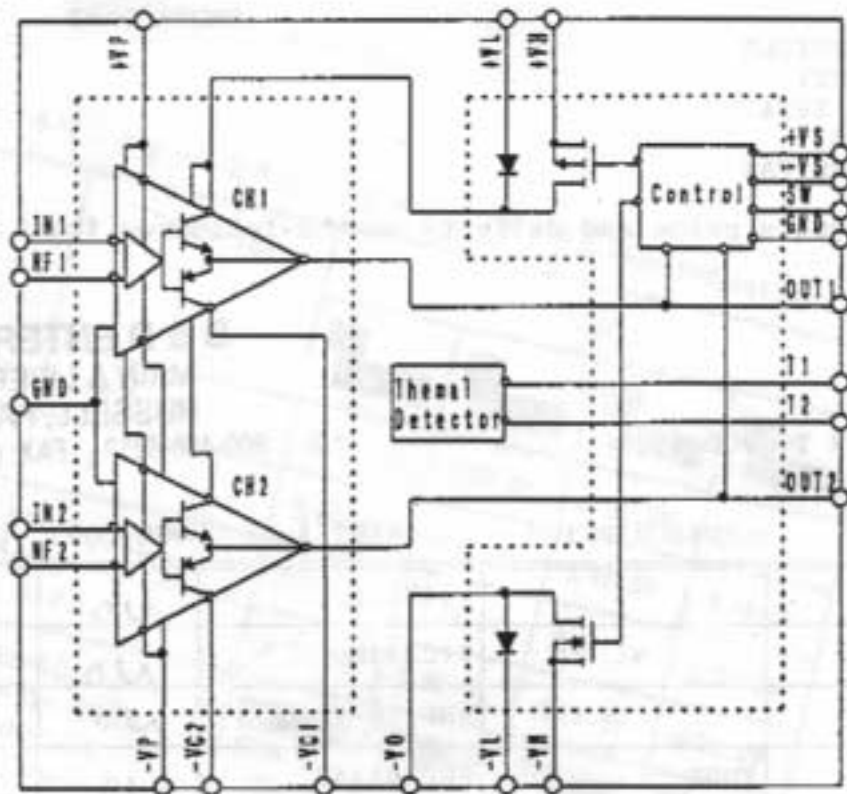

■ Case Outline

STK417-090 to STK417-130

