



ON Semiconductor®

<http://onsemi.com>

STK681-310

Thick-Film Hybrid IC

Forward/Reverse Motor Driver

Overview

The STK681-310 is a hybrid IC for use in current control forward/reverse DC motor driver with brush.

Applications

- Office photocopiers, printers, etc.

Features

- Allows forward, reverse, and brake operations in accordance with the external input signal.
- 4.2A startup output current and 8A peak brake output current.
- Incorporating a current detection resistor (0.10Ω), fixed current control is possible.
- Obviate the need to design for the dead time in order to turn off the upper- and lower drive devices when switching between the forward and reverse operation mode.

Specifications

Absolute maximum ratings at $T_c = 25^\circ\text{C}$

Parameter	Symbol	Conditions	Ratings	unit
Maximum supply voltage 1	V_{CC1} max	$V_{CC2}=0\text{V}$	52	V
Maximum supply voltage 2	V_{CC2} max	No signal	-0.3 to +7.0	V
Input voltage	V_{IN} max	Logic input pins	-0.3 to +7.0	V
Output current	I_O max	$V_{CC2}=5.0\text{V}$, DC current	4.2	A
Brake current	I_{OB} max	$V_{CC2}=5.0\text{V}$, square wave current, operating time 60ms (single pulse)	8	A
Allowable power dissipation	P_{dPK} max	No heat sink	3.1	W
Operating substrate temperature	T_c max		105	$^\circ\text{C}$
Junction temperature	T_j max		150	$^\circ\text{C}$
Storage temperature	T_{stg}		-40 to +125	$^\circ\text{C}$

Stresses exceeding Maximum Ratings may damage the device. Maximum Ratings are stress ratings only. Functional operation above the Recommended Operating Conditions is not implied. Extended exposure to stresses above the Recommended Operating Conditions may affect device reliability.

STK681-310

Allowable Operating Ranges at $T_a = 25^\circ\text{C}$

Parameter	Symbol	Conditions	Ratings	unit
Operating supply voltage 1	V_{CC1}	With signals applied	10 to 42	V
Operating supply voltage 2	V_{CC2}	With signals applied	$5 \pm 5\%$	V
Input voltage	V_{IN}		0 to V_{CC2}	V
Output current 1	I_{O1}	$V_{CC2}=5.0\text{V}$, DC current, $T_c \leq 70^\circ\text{C}$	4.2	A
Output current 2	I_{O2}	$V_{CC2}=5.0\text{V}$, DC current, $T_c = 90^\circ\text{C}$	3.2	A
Output current 3	I_{O3}	$V_{CC2}=5.0\text{V}$, DC current, $T_c = 105^\circ\text{C}$	2.5	A
Brake current	I_{OB}	$V_{CC2}=5.0\text{V}$, square wave current, operating time 3.6ms, $T_c = 105^\circ\text{C}$	8	A

Refer to the graph for each conduction-period tolerance range for the output current and brake current.

Electrical Characteristics at $T_c = 25^\circ\text{C}$, $V_{CC1} = 24\text{V}$, $V_{CC2} = 5.0\text{V}$

Parameter	Symbol	Conditions	min	typ	max	unit
V_{CC2} supply current	I_{CCO}	Forward or reverse operation		1.7	4	mA
FET diode forward voltage	V_{df}	$I_f = 1\text{A}$ ($R_L = 23\Omega$)		1.0	1.6	V
Output saturation voltage 1	V_{sat1}	$R_L = 23\Omega$, TR1, TR2		0.80	1.1	V
Output saturation voltage 2	V_{sat2}	$R_L = 23\Omega$, F1, F2+current detection resistance		0.19	0.26	V
Output leak current	I_{OL}	TR1, TR2, F1, and F2 OFF operation			50	μA
Input high voltage 1	V_{IH1}	IN1, IN2 pins	4.5			V
Input high voltage 2	V_{IH2}	INH pin	2.5			V
Input low voltage	V_{IL}	IN1, IN2, INH pins			0.6	V
Input current 1	I_{IH1}	IN1, IN2 pins, $V_{IH1} = 5\text{V}$	0.10	0.20	0.40	mA
Input current 2	I_{IH2}	INH pin, $V_{IH2} = 5\text{V}$	0.30	0.60	1.2	mA
Current setting voltage	V_{ref1}	Between pins V_{ref1} and S.P		0.42		V

Note: A fixed-voltage power supply must be used.

Package Dimensions

unit:mm (typ)

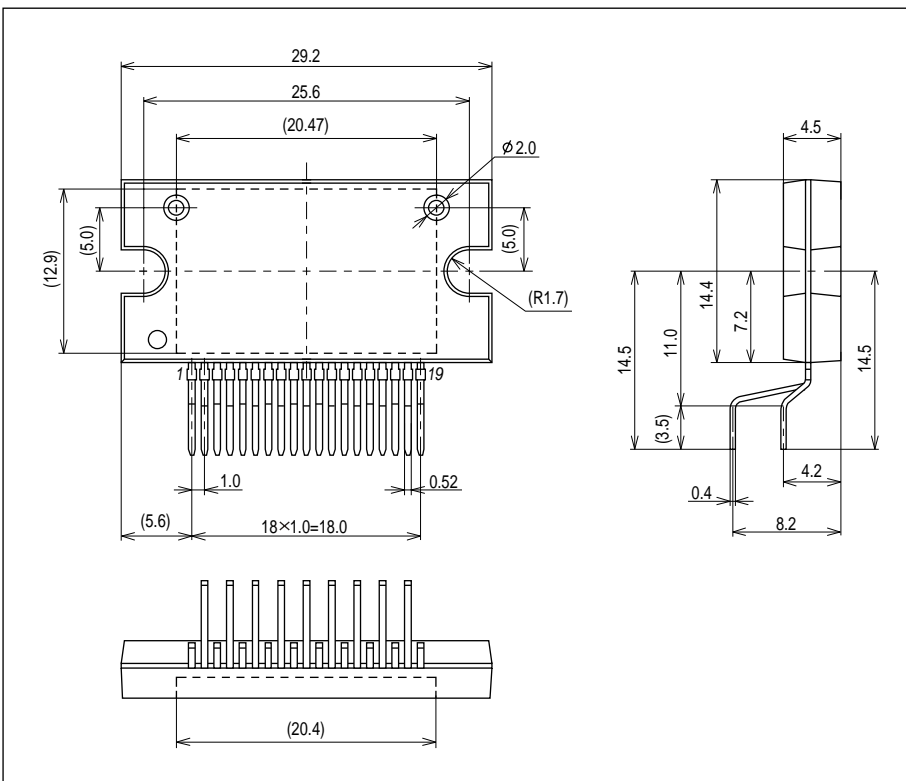

STK681-310

Derating Curve of Motor Current, I_O , vs. STK681-310 Operating Board Temperature, T_c

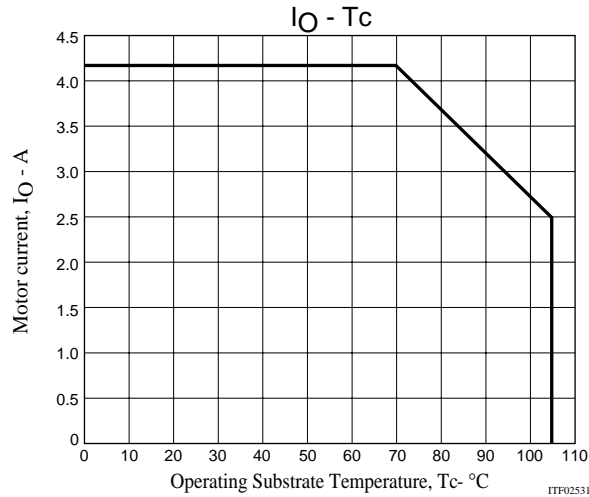

The range of DC operating current lies within the above derating curve in the V_{CC1} allowable operating range. The above motor current I_O is valid within the chopping operating range of $V_{CC1}=28V$ or lower. The above operating substrate temperature, T_c , is measured immediately when the motor is started. Since T_c fluctuates due to the ambient temperature, T_a , the motor current value, and continuous or intermittent operations of the motor current, always confirm this values using an actual set.

STK681-310 Allowable Brake Current Range

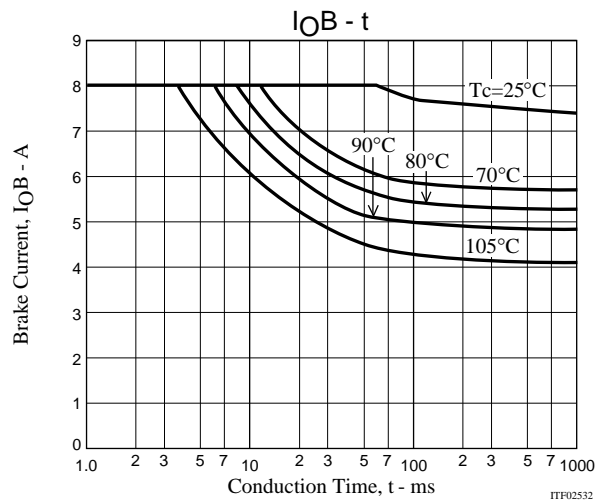

STK681-310

Internal Block Diagram

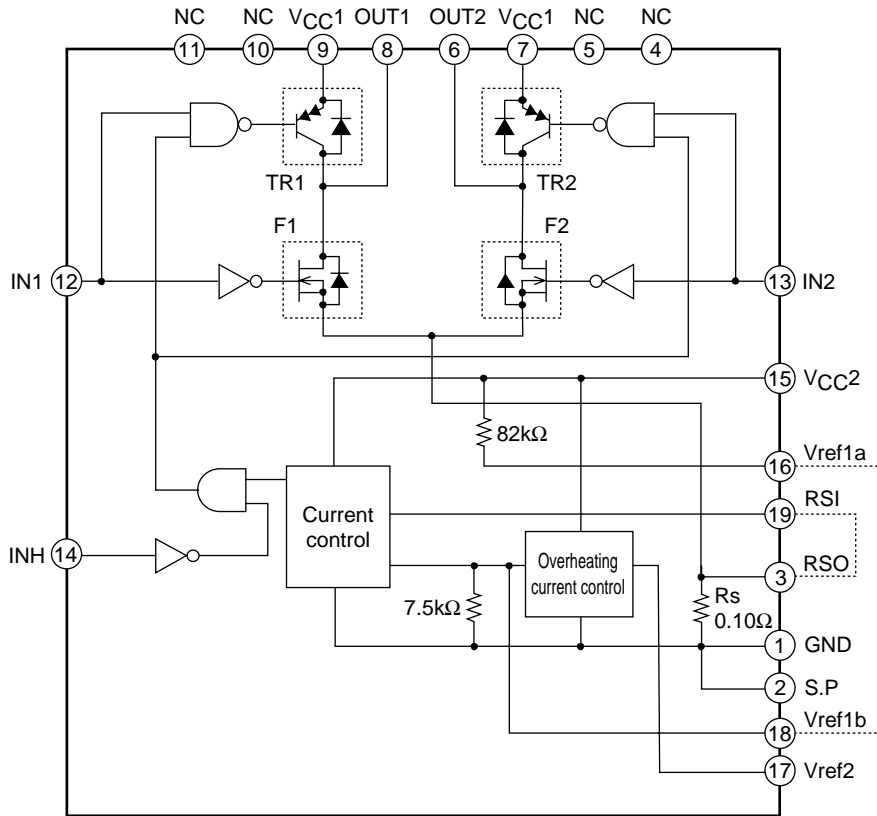

ITF02477

Sample Application Circuit

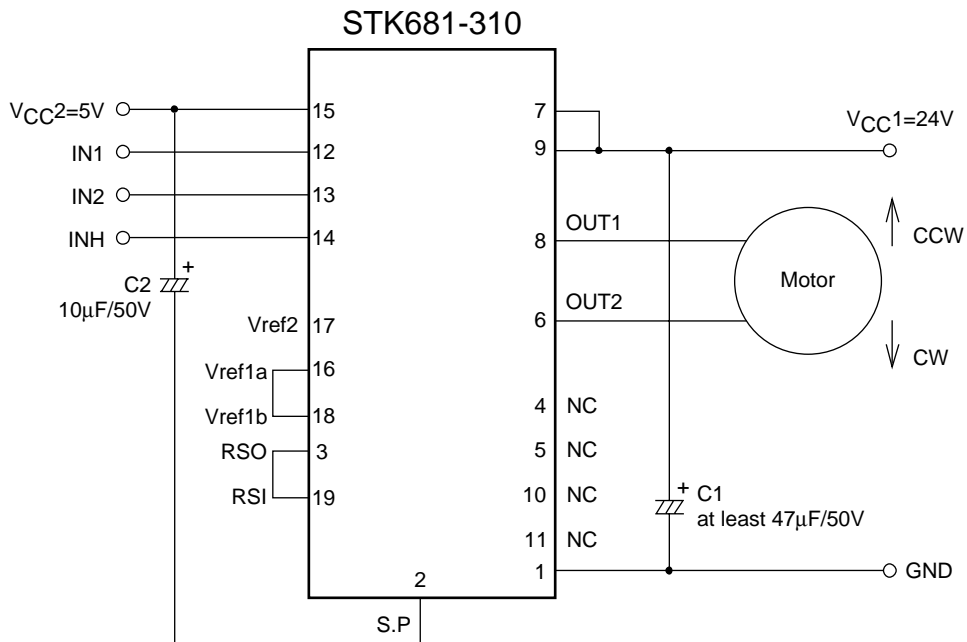

ITF02476

STK681-310

Motor Drive Conditions (H: High-level input; L: Low-Level Input)

	IN1	IN2	INH	Remarks
Stop 1 (standby)	H	H	H or L	When motor is not rotating
Stop 2 (supply power turned off by input during motor rotation)	H	H	H	Stop signal that is applied when the motor is running and used to turn off power.
	H	L	H	
	L	H	H	
Forward (CW)	H	L	L	No input signal is needed that turns off the upper- and lower-side drive devices when switching the rotational direction.
Reverse (CCW)	L	H	L	
Brake	L	L	L or H	GND side MOSFET ON

* IN1=IN2=H and INH=L are prohibited during motor rotation.

Notes

- (1) Be sure to set the capacitance of the power supply bypass capacitor, C1, so that the ripple current of the capacitor, which varies as motor current increases, falls within the allowed range.
- (2) Although the Vref2 pin is kept open, if connected to the GND or S.P pin, the overheating current control circuit ceases to function.
- (3) Fixed current chopping operations based on TR1 and TR2 are used for current control. The timing given below is used for OUT1 or OUT2 voltage output and for TR1 or TR2 collector current.

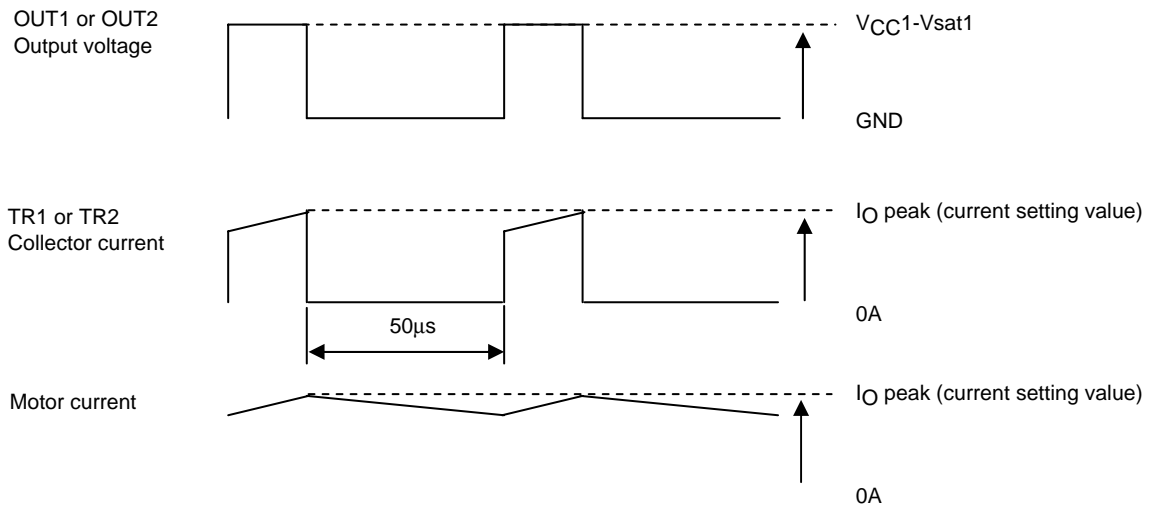

- (4) Do not connect the N.C pins shown in the internal block diagram or sample application circuit to a circuit pattern on the PCB.
- (5) This IC is not designed for use in an H-bridge driver for power supplies because the I/O response time of its GND side driving device, required when switching the motor rotational direction, is several scores of microseconds. It should be used only for DC motor drivers.

(6) Sample Timing Diagram

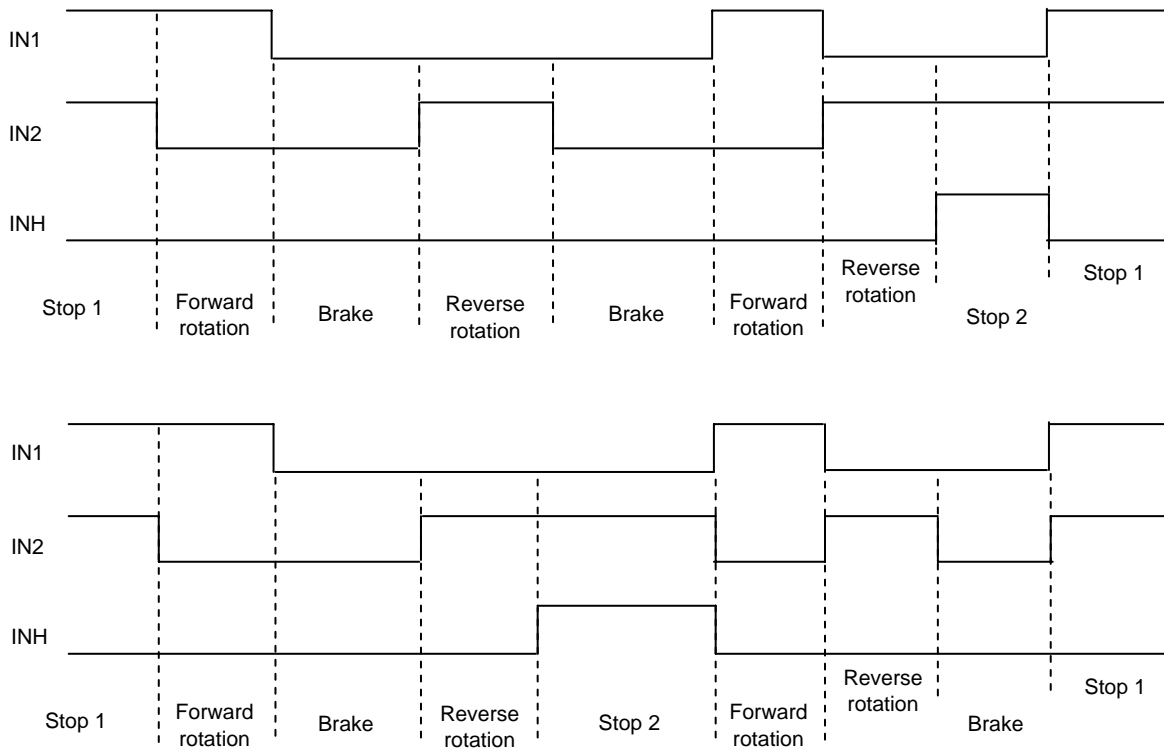

(7) Smoke Emission Precautions: There is a possibility of smoke emission if the hybrid IC is subjected to physical or electrical damage as the result of being used without compliance with the specifications.

I/O Functions of Each Pin

Pin Name	Pin No.	Function
IN1	12	Input pin for turning TR1 and F1 ON and OFF At high level, TR1: ON and F1: OFF; at low level TR1: OFF and F1: ON
IN2	13	Input pin for turning TR2 and F2 ON and OFF At high level, TR2: ON and F2: OFF; at low level, TR2: OFF and F2: ON
INH	14	Pin for turning TR1 and TR2 OFF; At high level TR1 and TR2: OFF This pin is usually low or open.
OUT1	8	This pin connects to the motor and outputs source/sync current depending on conditions at IN1 and IN2.
OUT2	6	This pin connects to the motor and outputs source/sync current depending on conditions at IN1 and IN2.
Vref1a Vref1b	16 18	This pin is used for current setting for constant-current operation performed with the Vrefa and Vrefb pins connected A voltage of 0.42V at Tc=25°C results for Vref1. 0.42V is set by connecting 82kΩ and 7.5kΩ in series. Current detection resistance is Rs=0.10Ω. Set using I _{O peak} =Vref1÷Rs.
Vref2	17	Be sure to usually leave this pin open. The overheating control circuit can be made to stop operating by connecting this pin to the GND or S.P pin.
S.P	2	Vref1 voltage can be lowered by connecting a resistor between the Vref1 and S.P pins.
RSO	3	This pin is used to monitor the voltage across the current sensing resistor, Rs. Must be connected to the RSI pin.
RSI	19	This pin is connected to the RSO pin and serves as an input to the circuit that compares the input with Vref1.

Technical Information

(1) Substrate temperature rise, ΔT_c (no heat sink) - Internal average power dissipation, PdAV

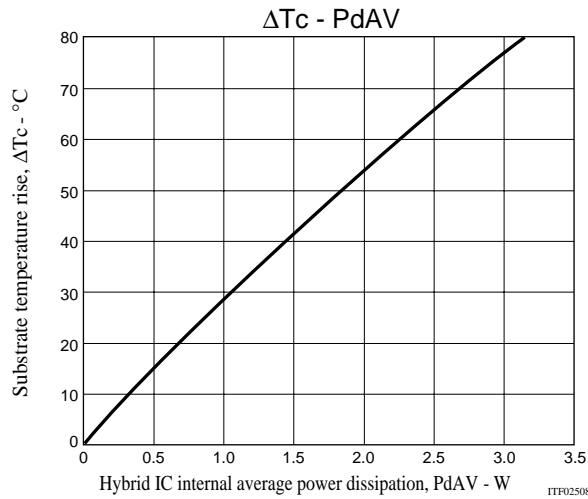

(2) Internal average power dissipation, Pd, in the DC current-motor current, I_Q, characteristics (typ values for Pd)

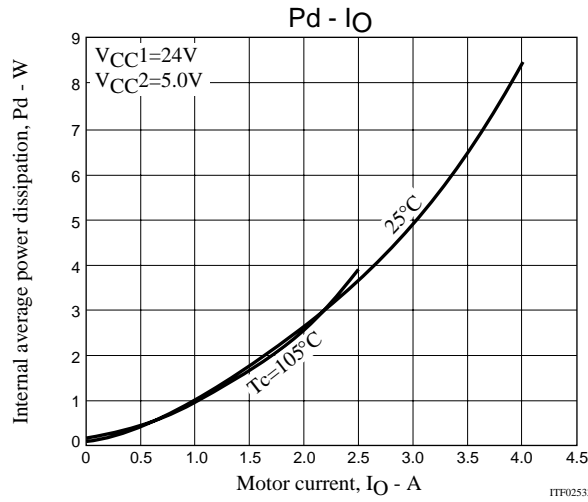

(3) Overheating current control characteristics

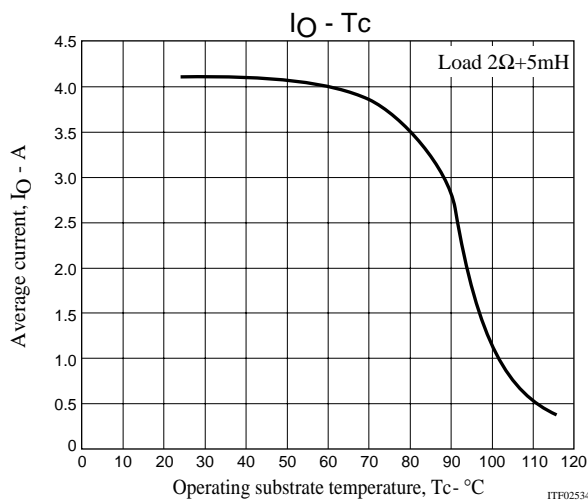

Overheating current control functions to prevent driver failure if a motor lock malfunction occurs.

STK681-310

(4) Derating curve of the package power dissipation, PdPK, against the ambient temperature, Ta

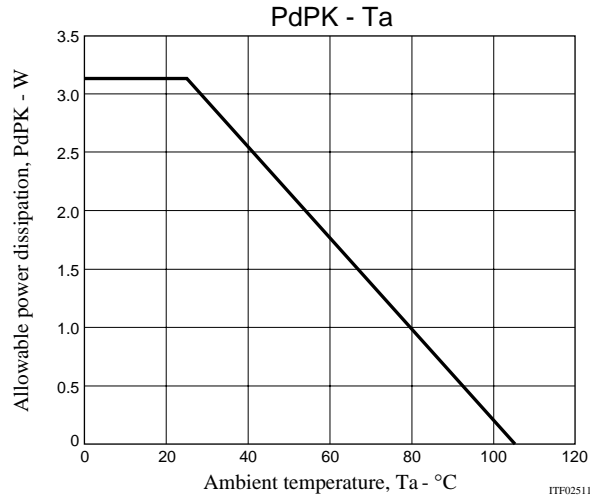

The package power dissipation, PdPK, refers to the internal average power dissipation, Pd, permissible if used without a heat sink

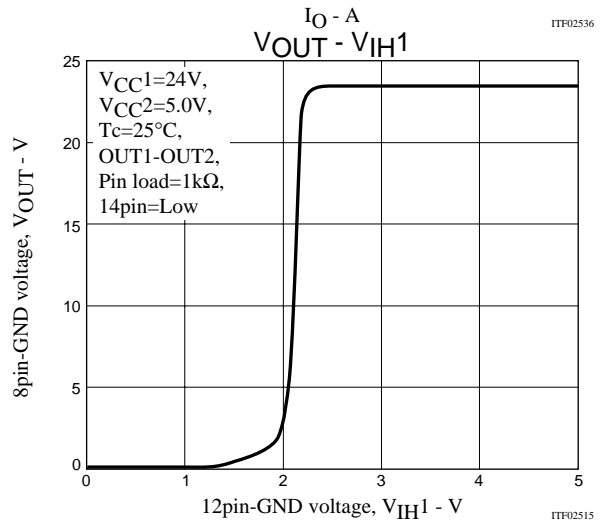
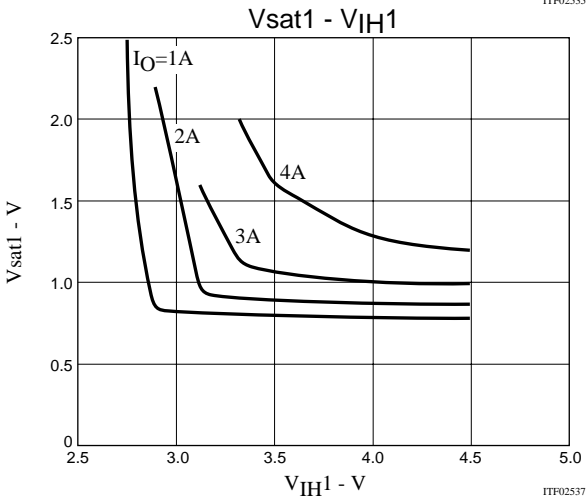
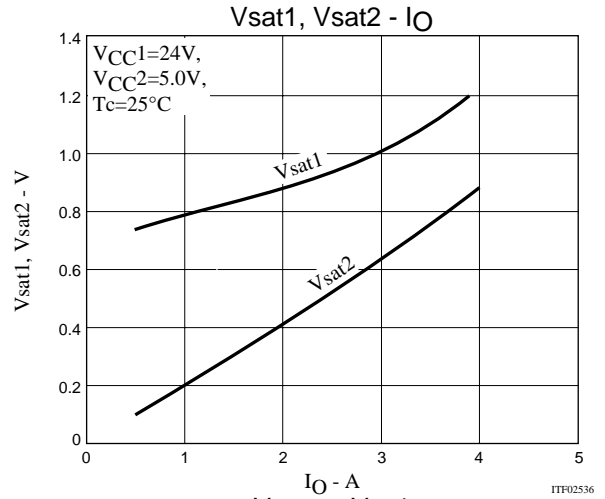
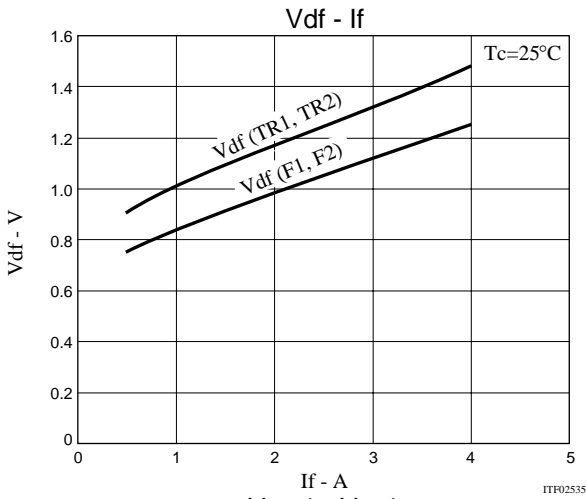

STK681-310

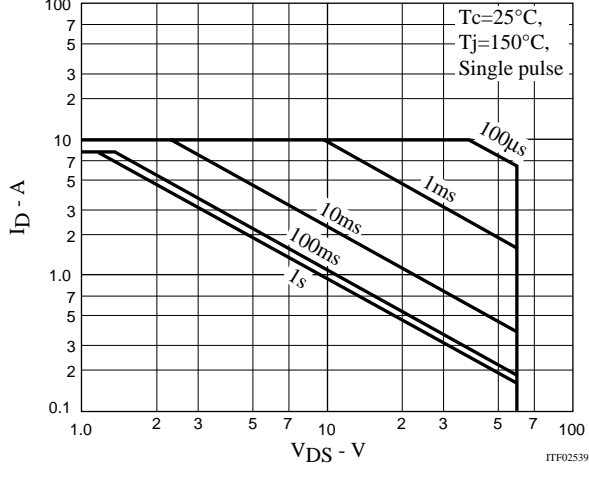
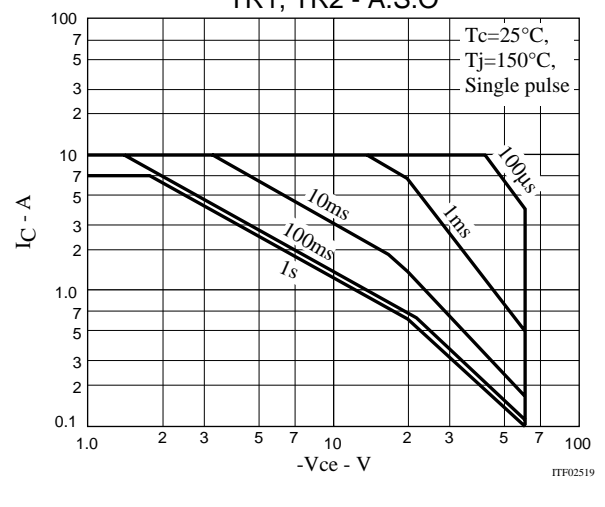
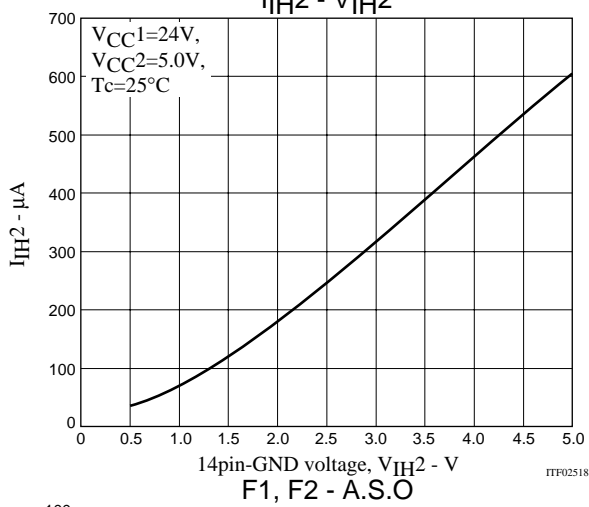
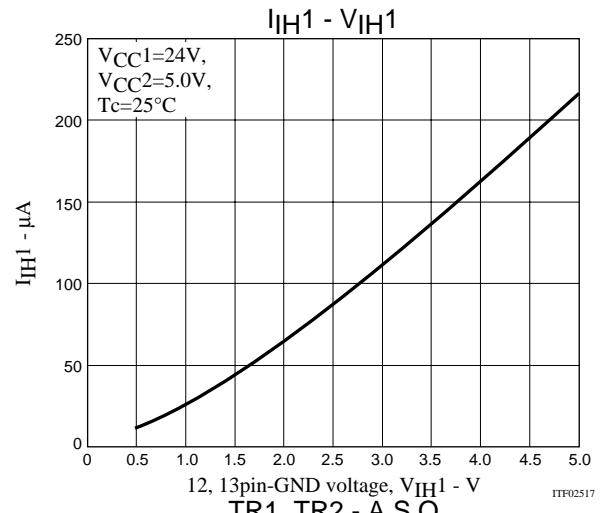
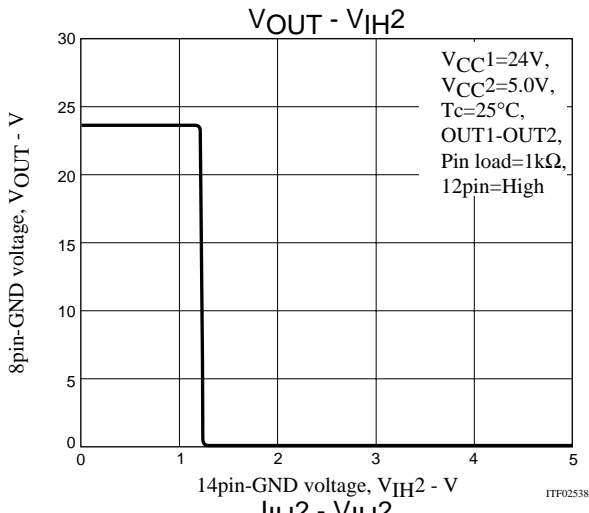

Input Pin Configurations

IN1, IN2

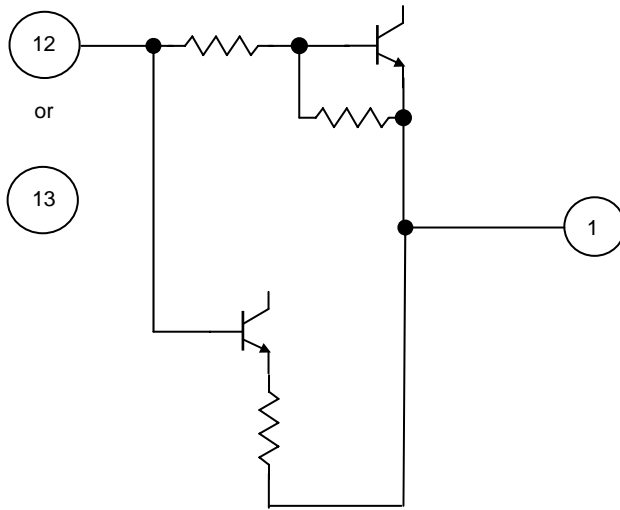

INH

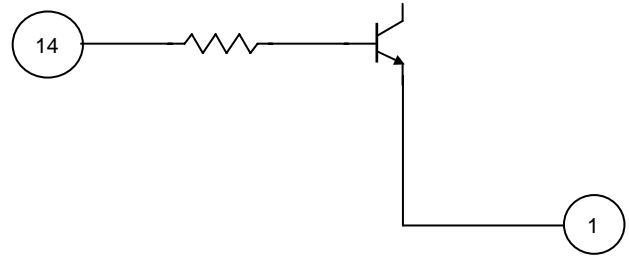

ON Semiconductor and the ON logo are registered trademarks of Semiconductor Components Industries, LLC (SCILLC). SCILLC owns the rights to a number of patents, trademarks, copyrights, trade secrets, and other intellectual property. A listing of SCILLC's product/patent coverage may be accessed at www.onsemi.com/site/pdf/Patent-Marking.pdf. SCILLC reserves the right to make changes without further notice to any products herein. SCILLC makes no warranty, representation or guarantee regarding the suitability of its products for any particular purpose, nor does SCILLC assume any liability arising out of the application or use of any product or circuit, and specifically disclaims any and all liability, including without limitation special, consequential or incidental damages. "Typical" parameters which may be provided in SCILLC data sheets and/or specifications can and do vary in different applications and actual performance may vary over time. All operating parameters, including "Typicals" must be validated for each customer application by customer's technical experts. SCILLC does not convey any license under its patent rights nor the rights of others. SCILLC products are not designed, intended, or authorized for use as components in systems intended for surgical implant into the body, or other applications intended to support or sustain life, or for any other application in which the failure of the SCILLC product could create a situation where personal injury or death may occur. Should Buyer purchase or use SCILLC products for any such unintended or unauthorized application, Buyer shall indemnify and hold SCILLC and its officers, employees, subsidiaries, affiliates, and distributors harmless against all claims, costs, damages, and expenses, and reasonable attorney fees arising out of, directly or indirectly, any claim of personal injury or death associated with such unintended or unauthorized use, even if such claim alleges that SCILLC was negligent regarding the design or manufacture of the part. SCILLC is an Equal Opportunity/Affirmative Action Employer. This literature is subject to all applicable copyright laws and is not for resale in any manner.