



STL21N65M5

N-channel 650 V, 0.175 Ω , 17 A ultra low gate charge MDmesh™ V Power MOSFET in PowerFLAT™ 8x8 HV package

Datasheet — production data

Features

Order code	V _{DSS} @ T _{Jmax}	R _{DS(on)} max	I _D
STL21N65M5	710 V	< 0.190 Ω	17 A ⁽¹⁾

1. The value is rated according to R_{thj-case}

- 100% avalanche tested
- Low input capacitance and gate charge
- Low gate input resistance

Applications

- Switching applications

Description

This device is an N-channel MDmesh™ V Power MOSFET based on an innovative proprietary vertical process technology, which is combined with STMicroelectronics' well-known PowerMESH™ horizontal layout structure. The resulting product has extremely low on-resistance, which is unmatched among silicon-based Power MOSFETs, making it especially suitable for applications which require superior power density and outstanding efficiency.

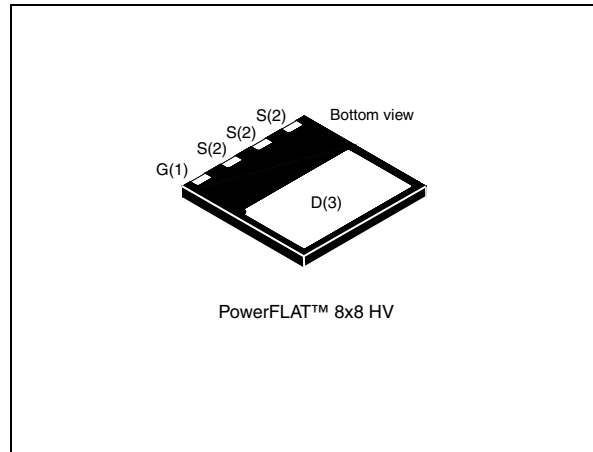

Figure 1. Internal schematic diagram

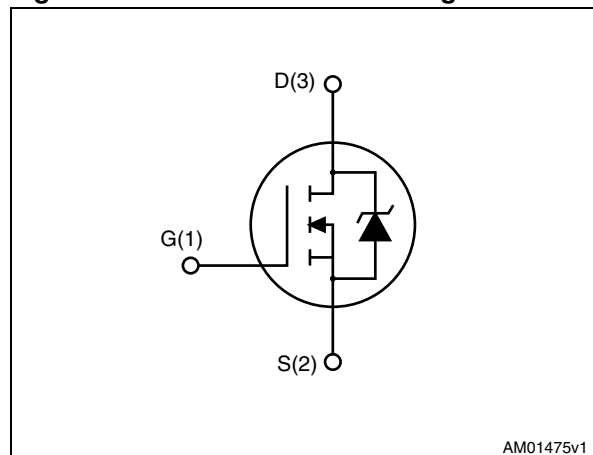

Table 1. Device summary

Order code	Marking	Package	Packaging
STL21N65M5	21N65M5	PowerFLAT™ 8x8 HV	Tape and reel

Contents

1	Electrical ratings	3
2	Electrical characteristics	4
2.1	Electrical characteristics (curves)	6
3	Test circuits	9
4	Package mechanical data	10
5	Packaging mechanical data	13
6	Revision history	15

1 Electrical ratings

Table 2. Absolute maximum ratings

Symbol	Parameter	Value	Unit
V_{DS}	Drain-source voltage	650	V
V_{GS}	Gate-source voltage	± 25	V
$I_D^{(1)}$	Drain current (continuous) at $T_C = 25\text{ }^\circ\text{C}$	17	A
$I_D^{(1)}$	Drain current (continuous) at $T_C = 100\text{ }^\circ\text{C}$	11	A
$I_{DM}^{(1),(2)}$	Drain current (pulsed)	68	A
$I_D^{(3)}$	Drain current (continuous) at $T_{amb} = 25\text{ }^\circ\text{C}$	2.7	A
$I_D^{(3)}$	Drain current (continuous) at $T_{amb} = 100\text{ }^\circ\text{C}$	1.7	A
$I_{DM}^{(2),(3)}$	Drain current (pulsed)	10.8	A
$P_{TOT}^{(3)}$	Total dissipation at $T_{amb} = 25\text{ }^\circ\text{C}$	3	W
$P_{TOT}^{(1)}$	Total dissipation at $T_C = 25\text{ }^\circ\text{C}$	125	W
I_{AR}	Avalanche current, repetitive or not-repetitive (pulse width limited by T_j max)	5	A
E_{AS}	Single pulse avalanche energy (starting $T_j = 25\text{ }^\circ\text{C}$, $I_D = I_{AR}$, $V_{DD} = 50\text{ V}$)	400	mJ
$dv/dt^{(4)}$	Peak diode recovery voltage slope	15	V/ns
T_{stg}	Storage temperature	- 55 to 150	$^\circ\text{C}$
T_j	Max. operating junction temperature	150	$^\circ\text{C}$

1. The value is rated according to $R_{thj-case}$.
2. Pulse width limited by safe operating area.
3. When mounted on FR-4 board of 1 inch^2 , 2oz Cu.
4. $I_{SD} \leq 17\text{ A}$, $di/dt \leq 400\text{ A}/\mu\text{s}$, $V_{Peak} < V_{(BR)DSS}$, $V_{DD} = 400\text{ V}$.

Table 3. Thermal data

Symbol	Parameter	Value	Unit
$R_{thj-case}$	Thermal resistance junction-case max	1	$^\circ\text{C}/\text{W}$
$R_{thj-amb}^{(1)}$	Thermal resistance junction-amb max	45	$^\circ\text{C}/\text{W}$

1. When mounted on 1 inch^2 FR-4 board, 2 oz Cu.

2 Electrical characteristics

($T_C = 25\text{ °C}$ unless otherwise specified)

Table 4. On /off states

Symbol	Parameter	Test conditions	Min.	Typ.	Max.	Unit
$V_{(BR)DSS}$	Drain-source breakdown voltage	$I_D = 1\text{ mA}$, $V_{GS} = 0$	650			V
I_{DSS}	Zero gate voltage drain current ($V_{GS} = 0$)	$V_{DS} = 650\text{ V}$ $V_{DS} = 650\text{ V}$, $T_C = 125\text{ °C}$			1 100	μA μA
I_{GSS}	Gate-body leakage current ($V_{DS} = 0$)	$V_{GS} = \pm 25\text{ V}$			± 100	nA
$V_{GS(th)}$	Gate threshold voltage	$V_{DS} = V_{GS}$, $I_D = 250\text{ }\mu\text{A}$	3	4	5	V
$R_{DS(on)}$	Static drain-source on-resistance	$V_{GS} = 10\text{ V}$, $I_D = 8.5\text{ A}$		0.175	0.190	Ω

Table 5. Dynamic

Symbol	Parameter	Test conditions	Min.	Typ.	Max.	Unit
C_{iss}	Input capacitance	$V_{DS} = 100\text{ V}$, $f = 1\text{ MHz}$, $V_{GS} = 0$	-	1950	-	pF
C_{oss}	Output capacitance			46		pF
C_{rss}	Reverse transfer capacitance			3		pF
$C_{o(tr)}^{(1)}$	Equivalent capacitance time related	$V_{DS} = 0\text{ to }520\text{ V}$, $V_{GS} = 0$	-	133	-	pF
$C_{o(er)}^{(2)}$	Equivalent capacitance energy related			44		pF
R_G	Intrinsic gate resistance	$f = 1\text{ MHz}$ open drain	-	2.5	-	Ω
Q_g	Total gate charge	$V_{DD} = 520\text{ V}$, $I_D = 8.5\text{ A}$, $V_{GS} = 10\text{ V}$ (see Figure 16)	-	44	-	nC
Q_{gs}	Gate-source charge			12		nC
Q_{gd}	Gate-drain charge			17		nC

1. $C_{oss\text{ eq}}$ time related is defined as a constant equivalent capacitance giving the same charging time as C_{oss} when V_{DS} increases from 0 to 80% V_{DSS}

2. $C_{oss\text{ eq}}$ energy related is defined as a constant equivalent capacitance giving the same stored energy as C_{oss} when V_{DS} increases from 0 to 80% V_{DSS}

Table 6. Switching times

Symbol	Parameter	Test conditions	Min.	Typ.	Max	Unit
$t_{d(off)}$	Turn-off delay time	$V_{DD} = 400\text{ V}$, $I_D = 11\text{ A}$,		37		ns
t_r	Rise time	$R_G = 4.7\ \Omega$, $V_{GS} = 10\text{ V}$	-	10	-	ns
t_c	Cross time	(see Figure 17),		24		ns
t_f	Fall time	(see Figure 20)		12		ns

Table 7. Source drain diode

Symbol	Parameter	Test conditions	Min.	Typ.	Max.	Unit
I_{SD}	Source-drain current		-		17	A
$I_{SDM}^{(1)}$	Source-drain current (pulsed)		-		68	A
$V_{SD}^{(2)}$	Forward on voltage	$I_{SD} = 17\text{ A}$, $V_{GS} = 0$	-		1.5	V
t_{rr}	Reverse recovery time	$I_{SD} = 17\text{ A}$, $di/dt = 100\text{ A}/\mu\text{s}$	-	294		ns
Q_{rr}	Reverse recovery charge	$V_{DD} = 100\text{ V}$ (see Figure 17)		4		μC
I_{RRM}	Reverse recovery current			28		A
t_{rr}	Reverse recovery time	$I_{SD} = 17\text{ A}$, $di/dt = 100\text{ A}/\mu\text{s}$	-	340		ns
Q_{rr}	Reverse recovery charge	$V_{DD} = 100\text{ V}$, $T_j = 150\text{ }^\circ\text{C}$		5		μC
I_{RRM}	Reverse recovery current	(see Figure 17)		29		A

1. Pulse width limited by safe operating area

2. Pulsed: pulse duration = 300 μs , duty cycle 1.5%

2.1 Electrical characteristics (curves)

Figure 2. Safe operating area

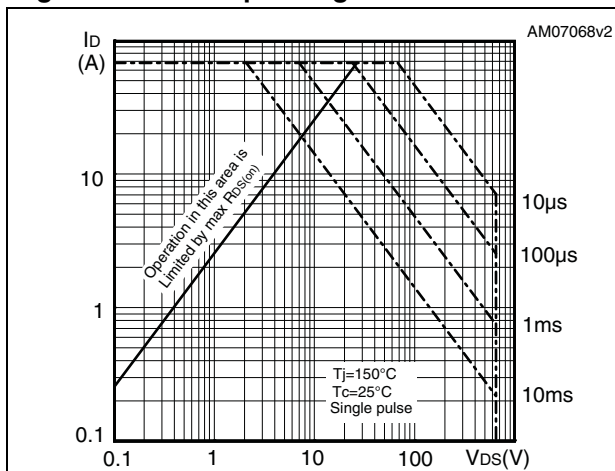

Figure 3. Thermal impedance

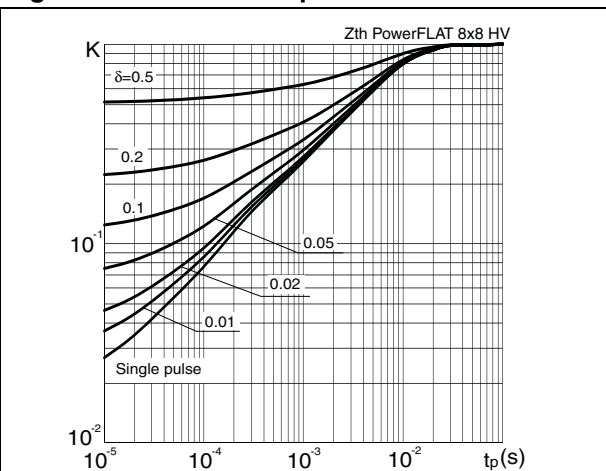

Figure 4. Output characteristics

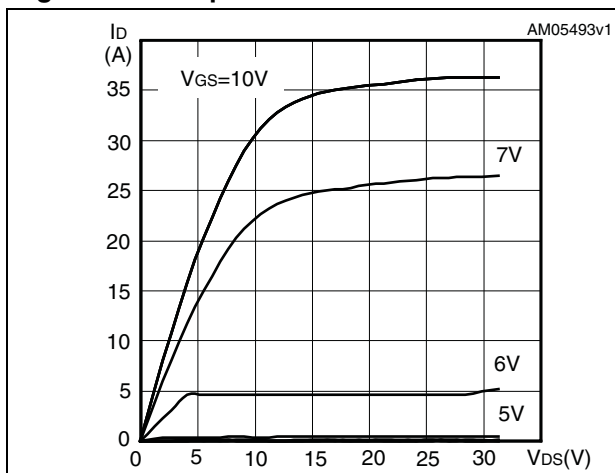

Figure 5. Transfer characteristics

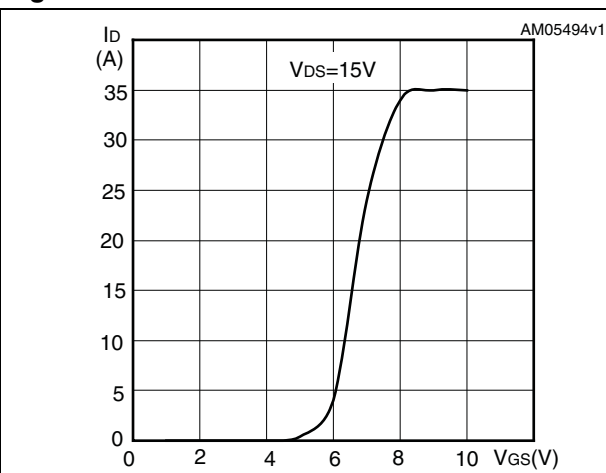

Figure 6. Gate charge vs gate-source voltage

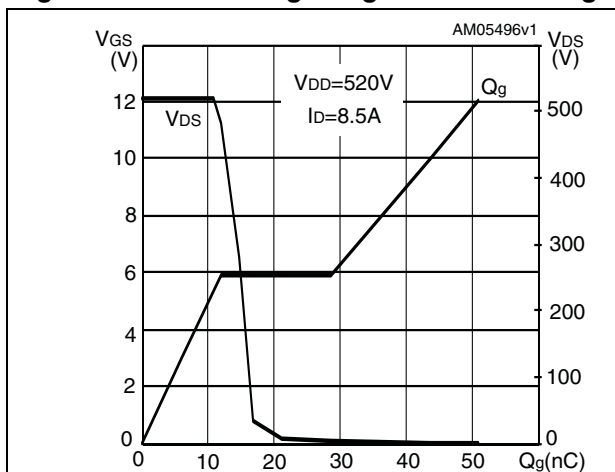

Figure 7. Static drain-source on-resistance

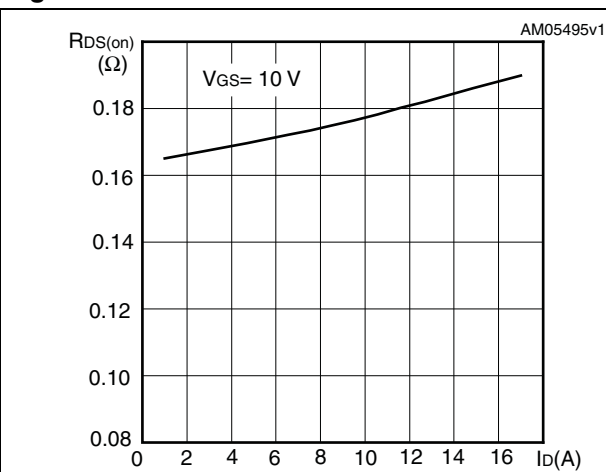

Figure 8. Output capacitance stored energy

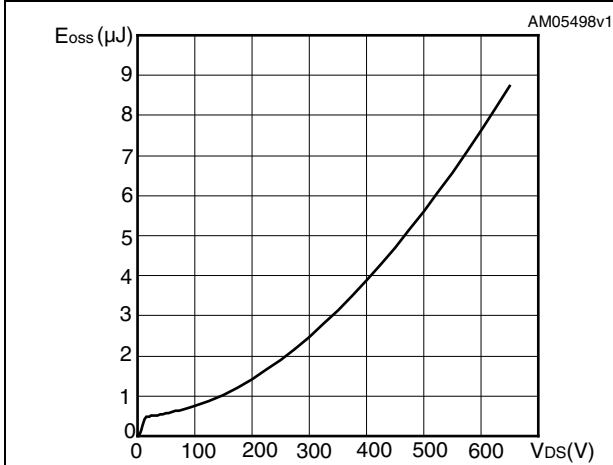

Figure 9. Capacitance variations

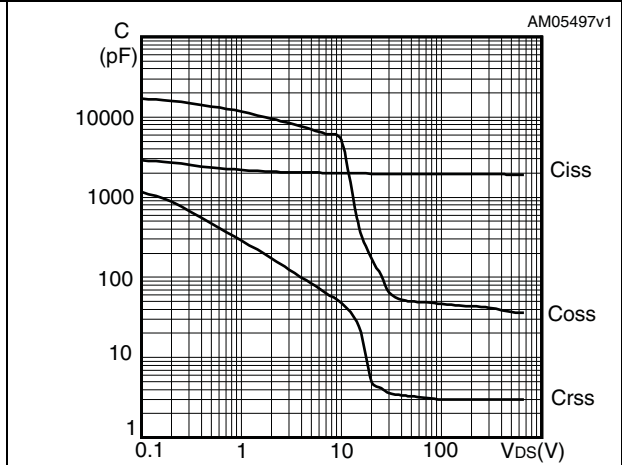

Figure 10. Normalized gate threshold voltage vs temperature

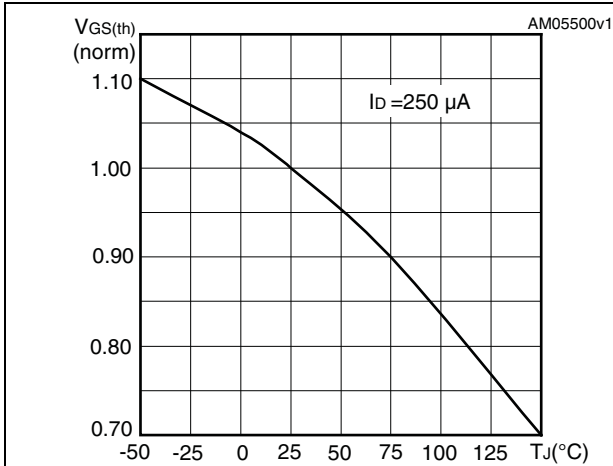

Figure 11. Normalized on-resistance vs temperature

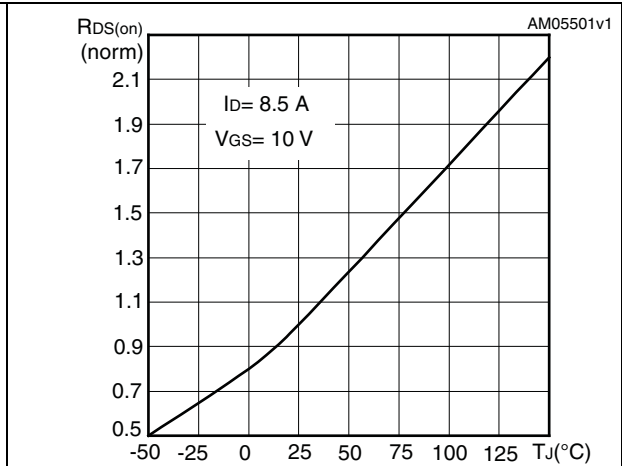

Figure 12. Source-drain diode forward characteristics

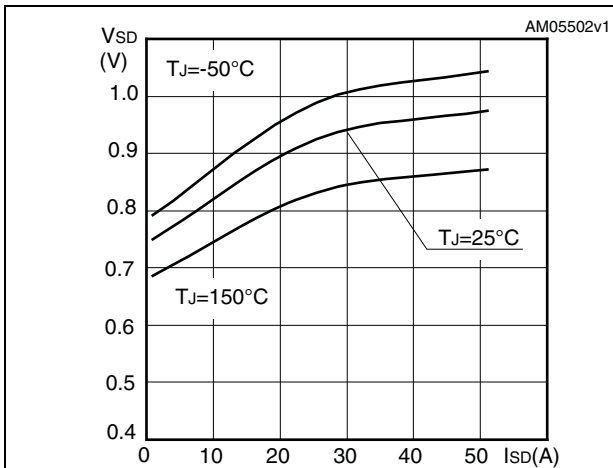

Figure 13. Normalized VDS vs temperature

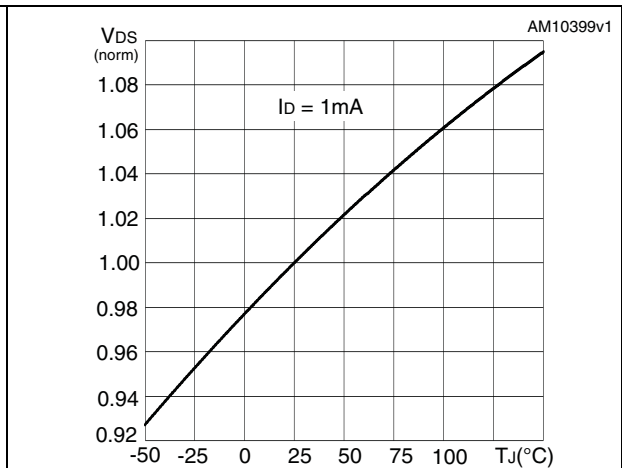
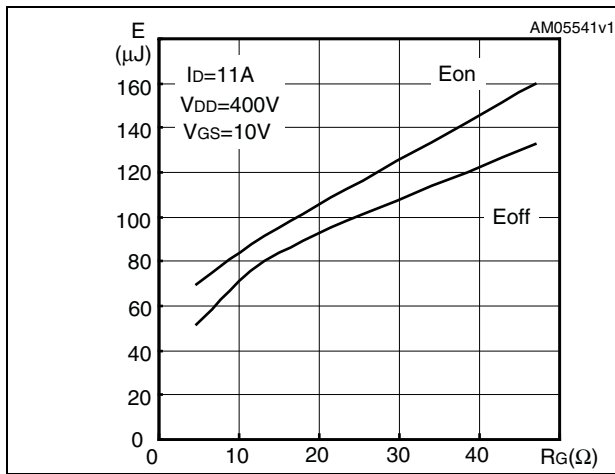

Figure 14. Switching losses vs gate resistance (1)



1. Eon including reverse recovery of a SiC diode

3 Test circuits

Figure 15. Switching times test circuit for resistive load



AM01468v1

Figure 16. Gate charge test circuit



AM01469v1

Figure 17. Test circuit for inductive load switching and diode recovery times



AM01470v1

Figure 18. Unclamped inductive load test circuit



AM01471v1

Figure 19. Unclamped inductive waveform

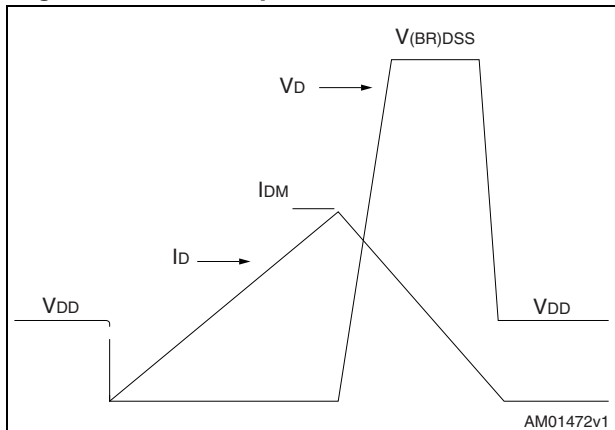

AM01472v1

Figure 20. Switching time waveform

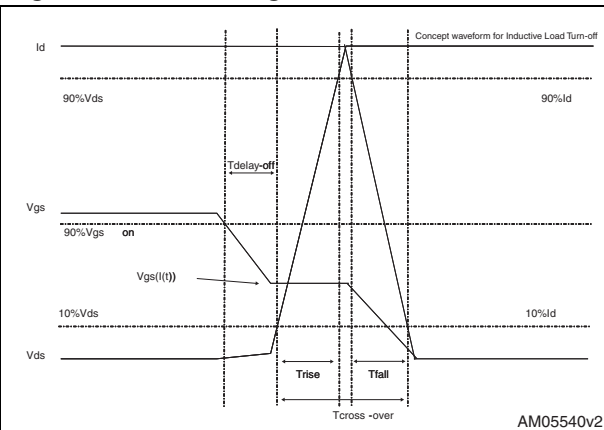

AM05540v2

4 Package mechanical data

In order to meet environmental requirements, ST offers these devices in different grades of ECOPACK® packages, depending on their level of environmental compliance. ECOPACK® specifications, grade definitions and product status are available at: www.st.com. ECOPACK is an ST trademark.

Table 8. PowerFLAT™ 8x8 HV mechanical data

Dim.	mm		
	Min.	Typ.	Max.
A	0.80	0.90	1.00
A1	0.00	0.02	0.05
b	0.95	1.00	1.05
D		8.00	
E		8.00	
D2	7.05	7.20	7.30
E2	4.15	4.30	4.40
e		2.00	
L	0.40	0.50	0.60
aaa		0.10	
bbb		0.10	
ccc		0.10	

Figure 21. PowerFLAT™ 8x8 HV drawing mechanical data

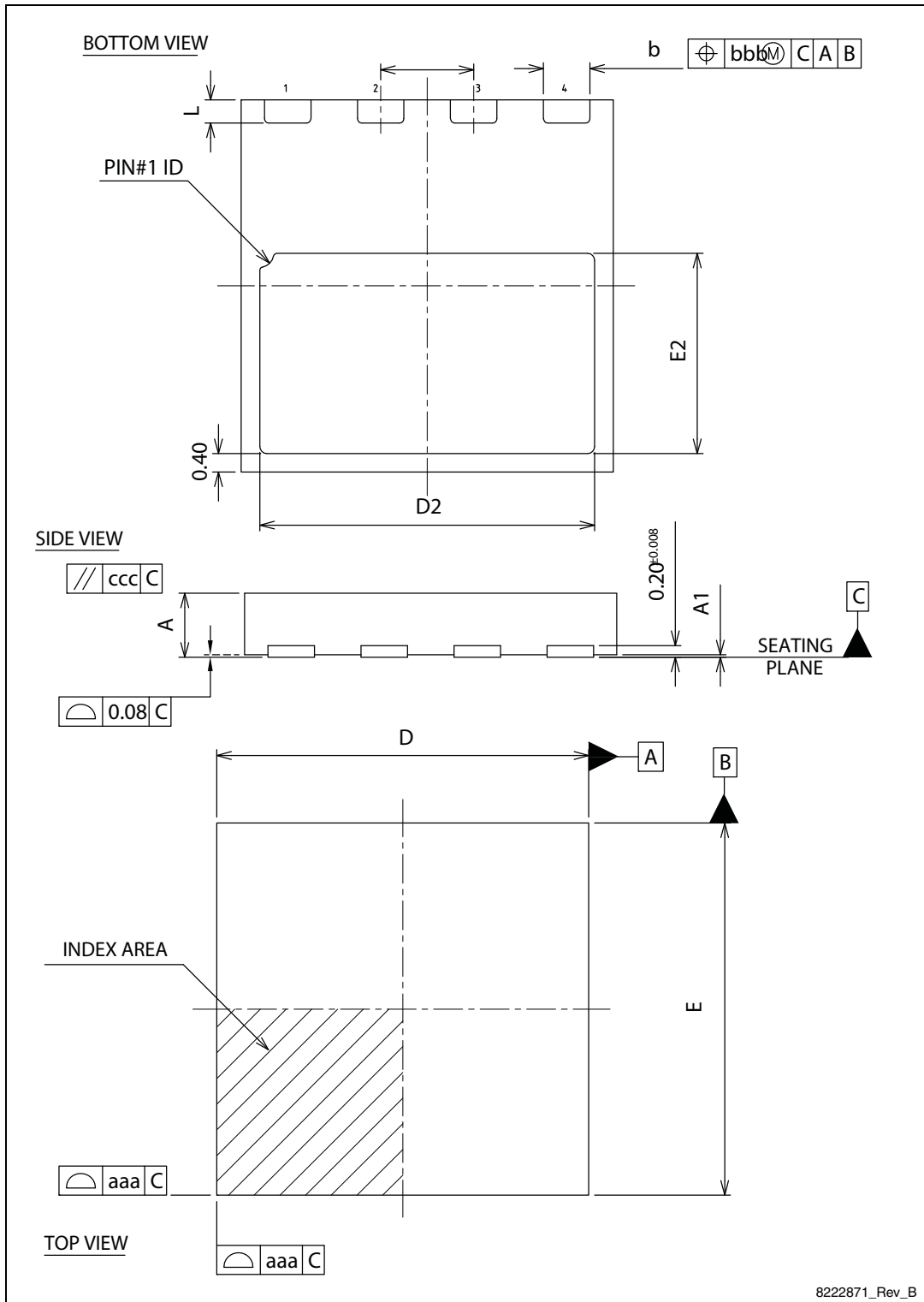
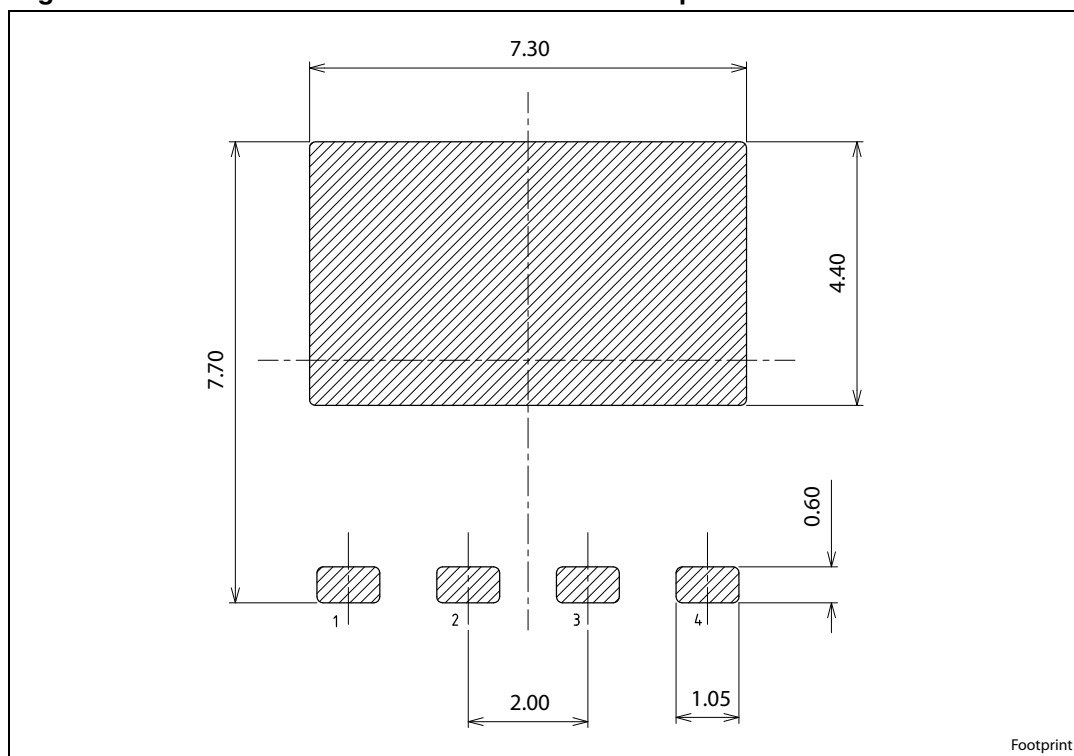

Figure 22. PowerFLAT™ 8x8 HV recommended footprint



5 Packaging mechanical data

Figure 23. PowerFLAT™ 8x8 HV tape

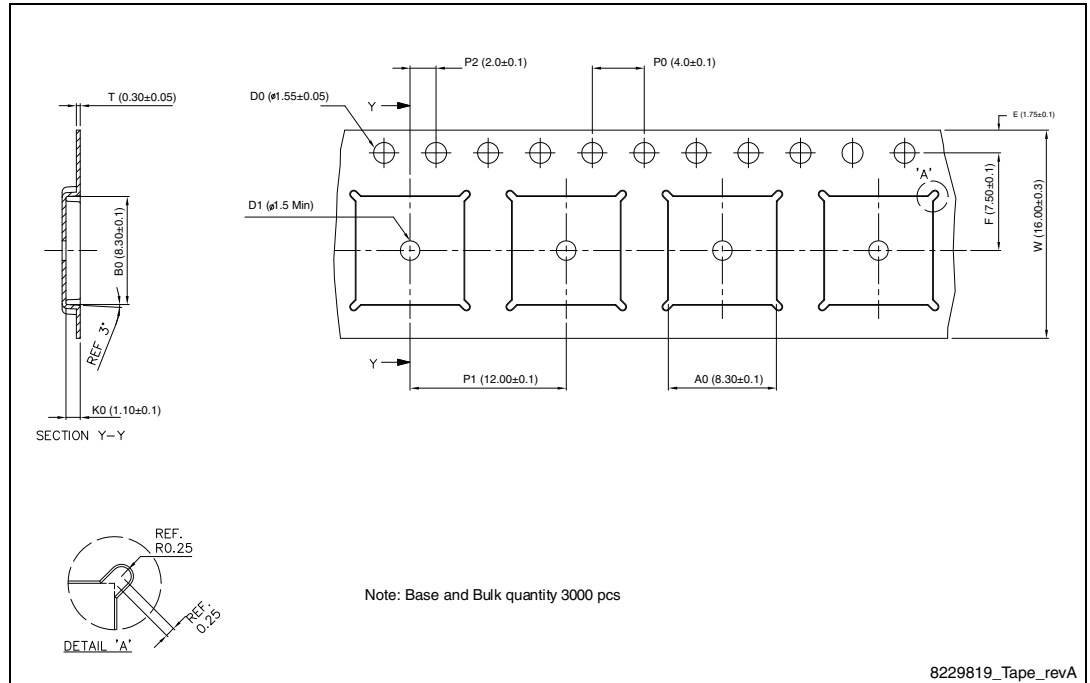

Figure 24. PowerFLAT™ 8x8 HV package orientation in carrier tape

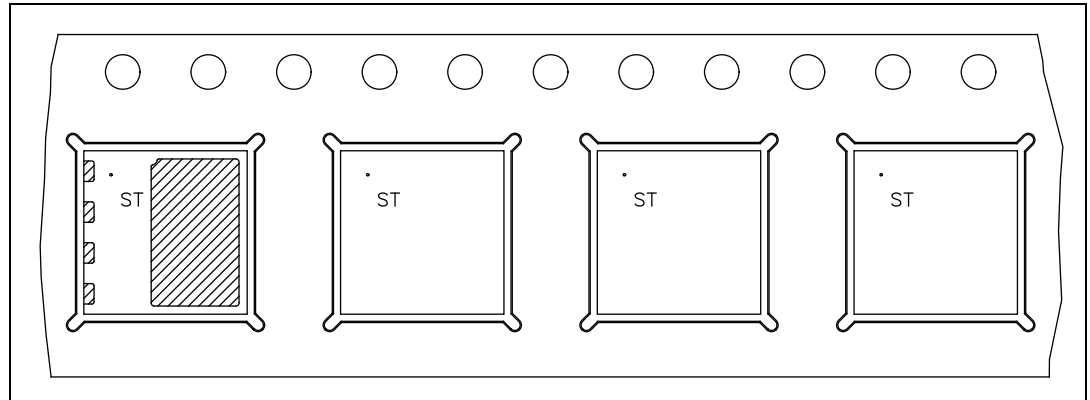
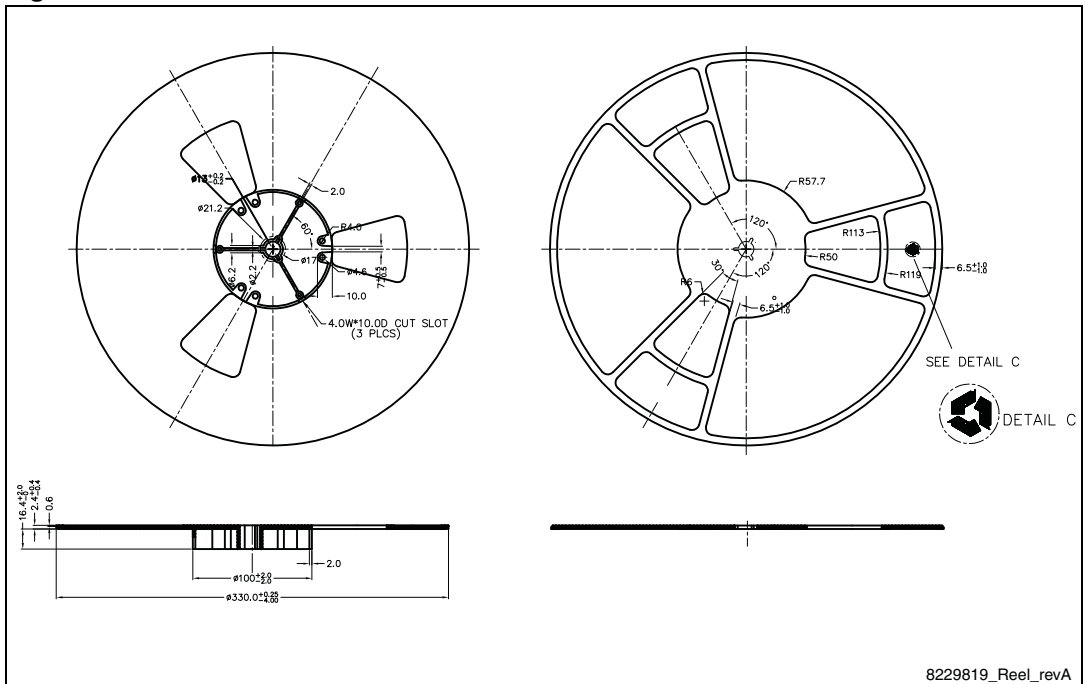

Figure 25. PowerFLAT™ 8x8 HV reel



6 Revision history

Table 9. Document revision history

Date	Revision	Changes
28-Apr-2010	1	First release.
14-Jun-2010	2	$R_{DS(on)}$ typical value has been corrected.
14-Mar-2011	3	<i>Figure 2: Safe operating area</i> , <i>Figure 3: Thermal impedance</i> and <i>Figure 7: Static drain-source on-resistance</i> have been updated.
18-May-2011	4	$R_{DS(on)}$ limits in <i>Table 4</i> have been updated.
29-May-2011	5	<i>Section 4: Package mechanical data</i> has been updated. Added new section: <i>Section 5: Packaging mechanical data</i> . Minor text changes.

Please Read Carefully:

Information in this document is provided solely in connection with ST products. STMicroelectronics NV and its subsidiaries ("ST") reserve the right to make changes, corrections, modifications or improvements, to this document, and the products and services described herein at any time, without notice.

All ST products are sold pursuant to ST's terms and conditions of sale.

Purchasers are solely responsible for the choice, selection and use of the ST products and services described herein, and ST assumes no liability whatsoever relating to the choice, selection or use of the ST products and services described herein.

No license, express or implied, by estoppel or otherwise, to any intellectual property rights is granted under this document. If any part of this document refers to any third party products or services it shall not be deemed a license grant by ST for the use of such third party products or services, or any intellectual property contained therein or considered as a warranty covering the use in any manner whatsoever of such third party products or services or any intellectual property contained therein.

UNLESS OTHERWISE SET FORTH IN ST'S TERMS AND CONDITIONS OF SALE ST DISCLAIMS ANY EXPRESS OR IMPLIED WARRANTY WITH RESPECT TO THE USE AND/OR SALE OF ST PRODUCTS INCLUDING WITHOUT LIMITATION IMPLIED WARRANTIES OF MERCHANTABILITY, FITNESS FOR A PARTICULAR PURPOSE (AND THEIR EQUIVALENTS UNDER THE LAWS OF ANY JURISDICTION), OR INFRINGEMENT OF ANY PATENT, COPYRIGHT OR OTHER INTELLECTUAL PROPERTY RIGHT.

UNLESS EXPRESSLY APPROVED IN WRITING BY TWO AUTHORIZED ST REPRESENTATIVES, ST PRODUCTS ARE NOT RECOMMENDED, AUTHORIZED OR WARRANTED FOR USE IN MILITARY, AIR CRAFT, SPACE, LIFE SAVING, OR LIFE SUSTAINING APPLICATIONS, NOR IN PRODUCTS OR SYSTEMS WHERE FAILURE OR MALFUNCTION MAY RESULT IN PERSONAL INJURY, DEATH, OR SEVERE PROPERTY OR ENVIRONMENTAL DAMAGE. ST PRODUCTS WHICH ARE NOT SPECIFIED AS "AUTOMOTIVE GRADE" MAY ONLY BE USED IN AUTOMOTIVE APPLICATIONS AT USER'S OWN RISK.

Resale of ST products with provisions different from the statements and/or technical features set forth in this document shall immediately void any warranty granted by ST for the ST product or service described herein and shall not create or extend in any manner whatsoever, any liability of ST.

ST and the ST logo are trademarks or registered trademarks of ST in various countries.

Information in this document supersedes and replaces all information previously supplied.

The ST logo is a registered trademark of STMicroelectronics. All other names are the property of their respective owners.

© 2012 STMicroelectronics - All rights reserved

STMicroelectronics group of companies

Australia - Belgium - Brazil - Canada - China - Czech Republic - Finland - France - Germany - Hong Kong - India - Israel - Italy - Japan - Malaysia - Malta - Morocco - Philippines - Singapore - Spain - Sweden - Switzerland - United Kingdom - United States of America

www.st.com