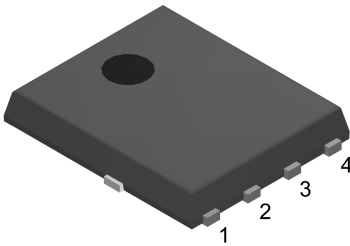
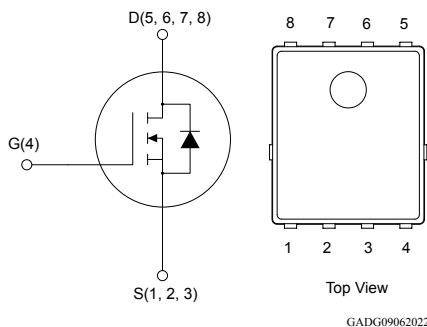

N-channel logic level 40 V, 1.0 mΩ max., 304 A, STripFET F8 Power MOSFET in a PowerFLAT 5x6 package

PowerFLAT 5x6

Features

Order code	V _{DS}	R _{DS(on)} max.	I _D
STL300N4LF8	40 V	1.0 mΩ	304 A

- MSL1 grade
- 175 °C maximum operating junction temperature
- 100% avalanche tested
- Low gate charge Q_G

Applications

- Industrial tools, motor drives and equipment
- Industrial motor control
- Power supplies and converters

Description

The **STL300N4LF8** is a 40 V N-channel enhancement mode Power MOSFET designed in STripFET F8 technology featuring an enhanced trench gate structure.

It ensures a state-of-the-art of figure of merit for very low on-state resistance while reducing internal capacitances and gate charge for faster and more efficient switching.



Product status link

[STL300N4LF8](#)

Product summary

Order code	STL300N4LF8
Marking⁽¹⁾	300N4LF8
Package	PowerFLAT 5x6
Packing	Tape and reel

1. For engineering samples marking, see Section 3.3: PowerFLAT 5x6 marking information.

1 Electrical ratings

Table 1. Absolute maximum ratings (at $T_C = 25\text{ °C}$ unless otherwise specified)

Symbol	Parameter	Value	Unit
V_{DS}	Drain-source voltage	40	V
V_{GS}	Gate-source voltage	± 20	V
$I_D^{(1)}$	Drain current (continuous) at $T_C = 25\text{ °C}^{(2)}$	304	A
	Drain current (continuous) at $T_C = 100\text{ °C}^{(2)}$	215	
	Drain current (continuous) at $T_C = 25\text{ °C}^{(3)}$	120	
$I_{DM}^{(1)(2)(4)}$	Drain current (pulsed, $t_p = 10\text{ }\mu\text{s}$)	1217	A
P_{TOT}	Total power dissipation at $T_C = 25\text{ °C}$	167	W
I_{AS}	Single pulse avalanche current (pulse width limited by T_J max.)	60	A
E_{AS}	Single pulse avalanche energy (starting $T_J = 25\text{ °C}$, $I_D = 60\text{ A}$, $R_{Gmin} = 25\text{ }\Omega$)	420	mJ
T_J	Operating junction temperature range	-55 to 175	$^{\circ}\text{C}$
T_{stg}	Storage temperature range		$^{\circ}\text{C}$

1. Specified by design, not tested in production.
2. This is the theoretical current value only related to the silicon.
3. This current value is limited by package.
4. Pulse width is limited by safe operating area.

Table 2. Thermal data

Symbol	Parameter	Value	Unit
$R_{thJA}^{(1)}$	Thermal resistance, junction-to-ambient (on 2s2p FR-4 board vertical in still area)	16.5	$^{\circ}\text{C/W}$
R_{thJC}	Thermal resistance, junction-to-case max.	0.9	$^{\circ}\text{C/W}$

1. Defined according to JEDEC standards (JESD51-5, -7).

2 Electrical characteristics

$T_J = 25\text{ °C}$ unless otherwise specified.

Table 3. On/off states

Symbol	Parameter	Test conditions	Min.	Typ.	Max.	Unit
$V_{(BR)DSS}$	Drain-source breakdown voltage	$V_{GS} = 0\text{ V}, I_D = 1\text{ mA}$	40			V
I_{DSS}	Zero gate voltage drain current	$V_{DS} = 40\text{ V}, V_{GS} = 0\text{ V}$			1	μA
		$V_{DS} = 40\text{ V}, V_{GS} = 0\text{ V},$ $T_J = 125\text{ °C}^{(1)}$			100	
I_{GSS}	Gate-body leakage current	$V_{GS} = 20\text{ V}, V_{DS} = 0\text{ V}$			100	nA
$V_{GS(th)}$	Gate threshold voltage	$V_{DS} = V_{GS}, I_D = 250\text{ }\mu\text{A}$	1.2		2.0	V
$R_{DS(on)}$	Static drain-source on-resistance	$V_{GS} = 10\text{ V}, I_D = 60\text{ A}$		0.8	1.0	m Ω
		$V_{GS} = 4.5\text{ V}, I_D = 60\text{ A}$		1.15	1.5	
R_G	Gate resistance			1.0		Ω

1. Specified by design and evaluated by characterization, not tested in production.

Table 4. Dynamic

Symbol	Parameter	Test conditions	Min.	Typ.	Max.	Unit
$C_{iss}^{(1)}$	Input capacitance	$V_{DS} = 25\text{ V}, f = 1\text{ MHz}, V_{GS} = 0\text{ V}$	-	5400	-	pF
$C_{oss}^{(1)}$	Output capacitance		-	1700	-	pF
$C_{rss}^{(1)}$	Reverse transfer capacitance		-	25	-	pF
$Q_g^{(1)}$	Total gate charge	$V_{DD} = 20\text{ V}, I_D = 60\text{ A}, V_{GS} = 0\text{ to }4.5\text{ V}$	-	30	-	nC
		$V_{DD} = 20\text{ V}, I_D = 60\text{ A}, V_{GS} = 0\text{ to }10\text{ V}$	-	70	-	
$Q_{gs}^{(1)}$	Gate-source charge	$V_{DD} = 20\text{ V}, I_D = 60\text{ A}, V_{GS} = 0\text{ to }4.5\text{ V}$	-	19	-	nC
$Q_{gd}^{(1)}$	Gate-drain charge		-	5	-	nC
$Q_{g(sync)}^{(1)}$	Total gate charge, sync. MOSFET	$V_{DS} = 0.1\text{ V}, V_{GS} = 0\text{ to }4.5\text{ V}$	-	63	-	nC
$Q_{oss}^{(1)}$	Output charge	$V_{DD} = 20\text{ V}, V_{GS} = 0\text{ V}$	-	75	-	nC

1. Specified by design and evaluated by characterization, not tested in production.

Table 5. Switching times

Symbol	Parameter	Test conditions	Min.	Typ.	Max.	Unit
$t_{d(on)}^{(1)}$	Turn-on delay time	$V_{DD} = 20\text{ V}, I_D = 60\text{ A},$ $R_G = 4.7\text{ }\Omega, V_{GS} = 10\text{ V}$	-	14	-	ns
$t_r^{(1)}$	Rise time		-	6	-	ns
$t_{d(off)}^{(1)}$	Turn-off delay time		-	55	-	ns
$t_f^{(1)}$	Fall time		-	9	-	ns

1. Specified by design and evaluated by characterization, not tested in production.

Table 6. Source-drain diode

Symbol	Parameter	Test conditions	Min.	Typ.	Max.	Unit
$I_{SD}^{(1)(2)}$	Forward on current (continuous)	$T_C = 25\text{ }^\circ\text{C}$	-		121	A
V_{SD}	Forward on voltage	$I_{SD} = 60\text{ A}, V_{GS} = 0\text{ V}$	-		1.1	V
$t_{rr}^{(1)}$	Reverse recovery time	$I_D = 60\text{ A}, di/dt = 100\text{ A}/\mu\text{s}, V_{DD} = 32\text{ V}$	-	60		ns
$Q_{rr}^{(1)}$	Reverse recovery charge		-	70		nC
$I_{RRM}^{(1)}$	Reverse recovery current		-	2.5		A

1. Specified by design and evaluated by characterization, not tested in production.
2. This is the theoretical current value only related to the silicon.

2.1 Electrical characteristics (curves)

Figure 1. Total power dissipation

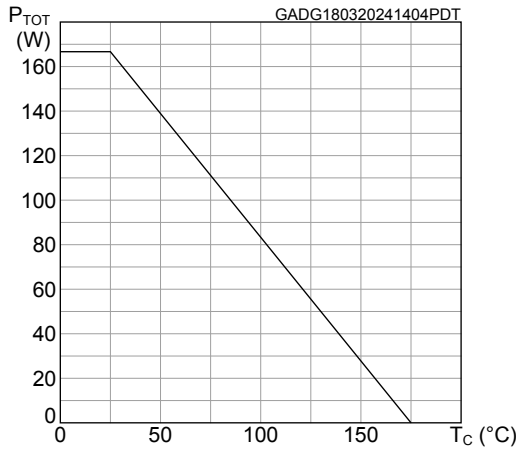

Figure 2. Drain current vs case temperature

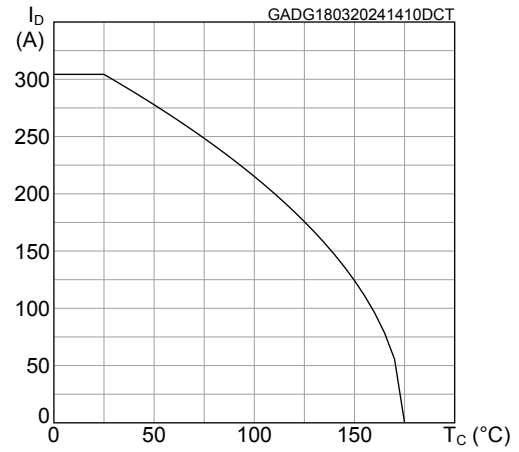

Figure 3. Safe operating area

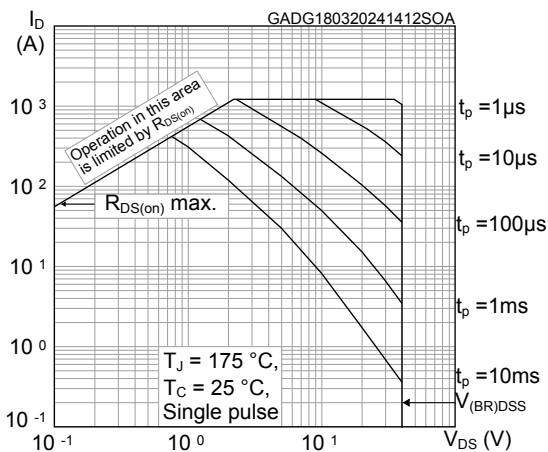

Figure 4. Normalized transient thermal impedance

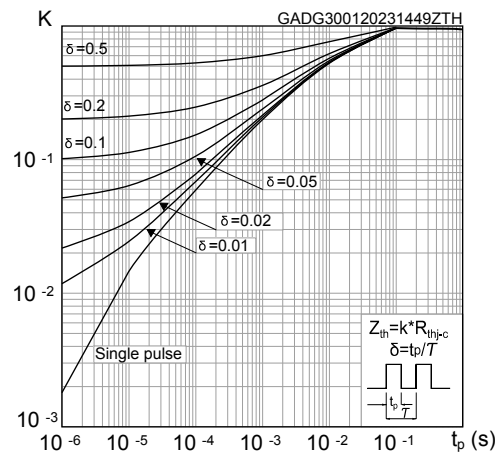

Figure 5. Avalanche characteristics

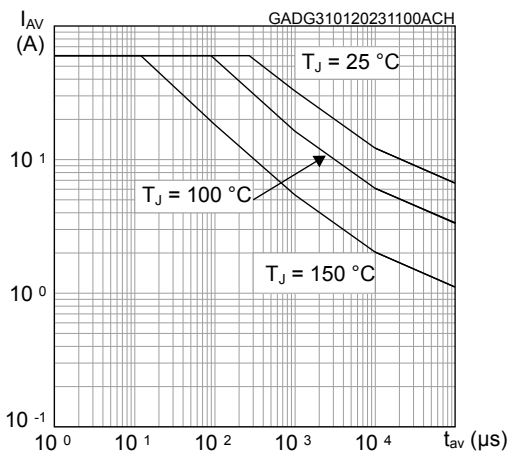

Figure 6. Avalanche energy

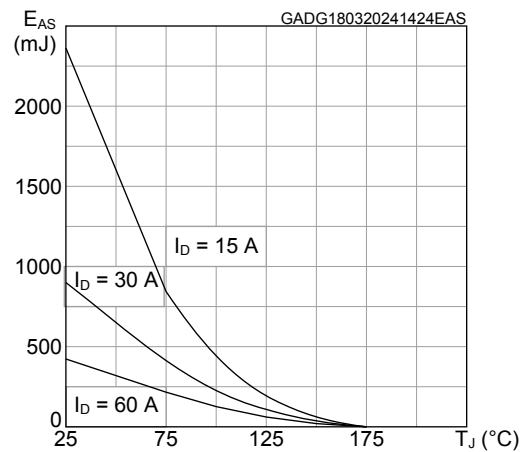

Figure 7. Normalized on-resistance vs temperature

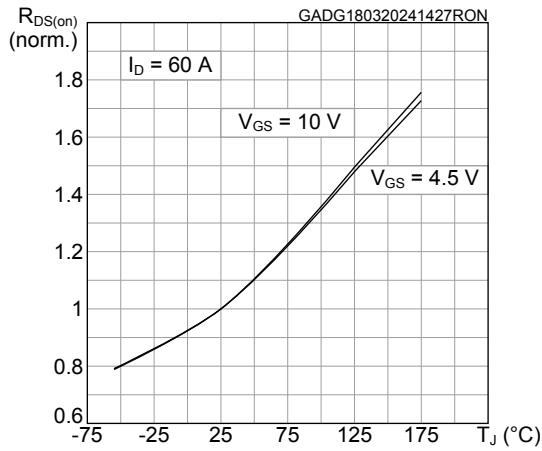

Figure 8. Normalized gate threshold voltage vs temperature

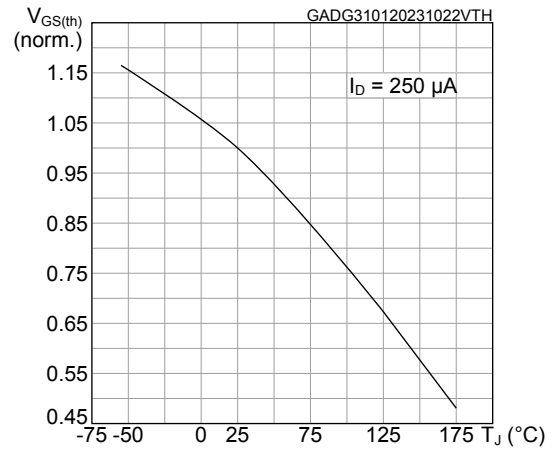

Figure 9. Typical reverse diode forward characteristics

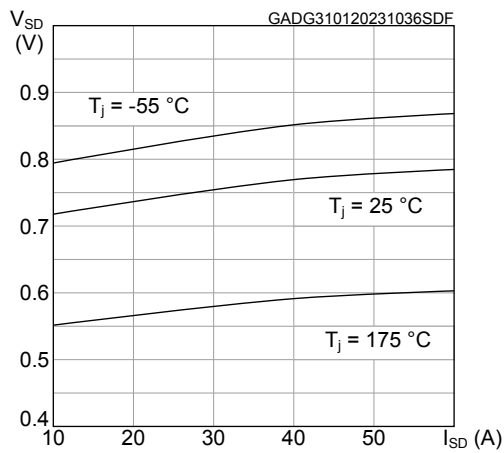

Figure 10. Normalized $V_{(BR)DSS}$ vs temperature

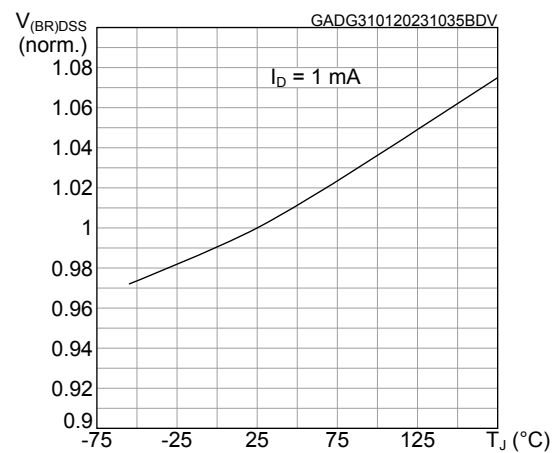

Figure 11. Typical output characteristics

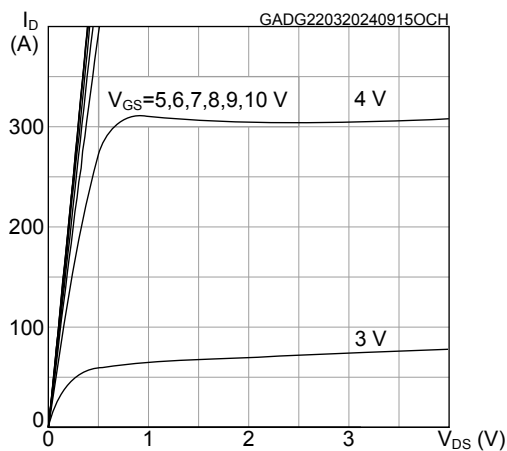

Figure 12. Typical transfer characteristics

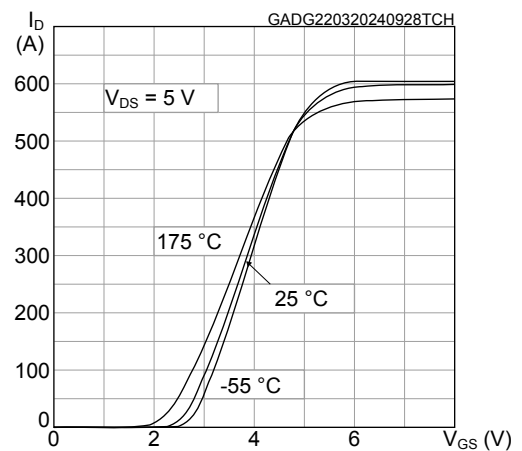

Figure 13. Typical drain-source on-resistance

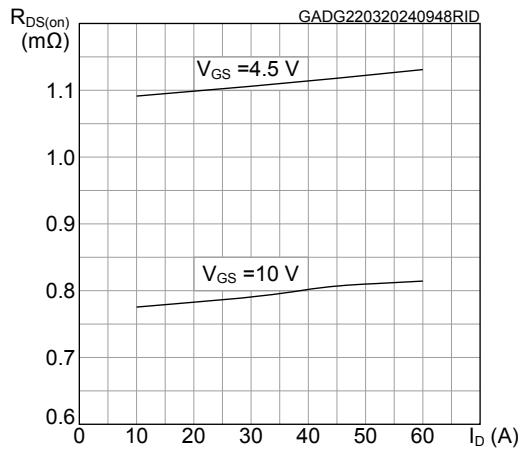

Figure 14. Typical on-resistance vs gate-source voltage

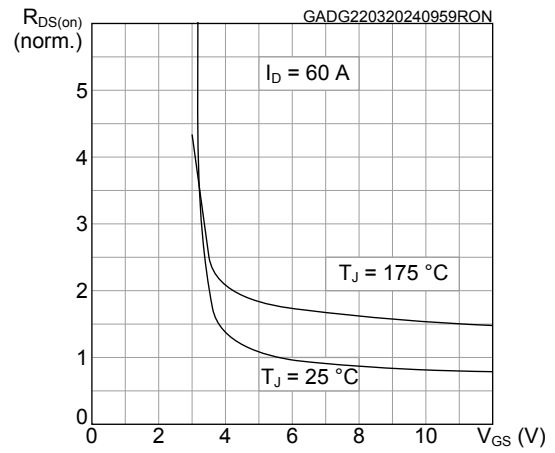

Figure 15. Typical gate charge characteristics

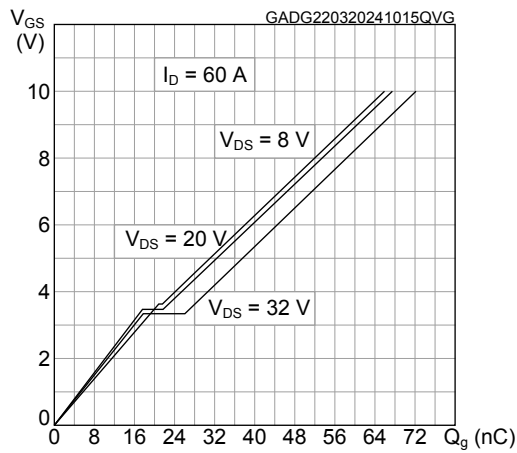
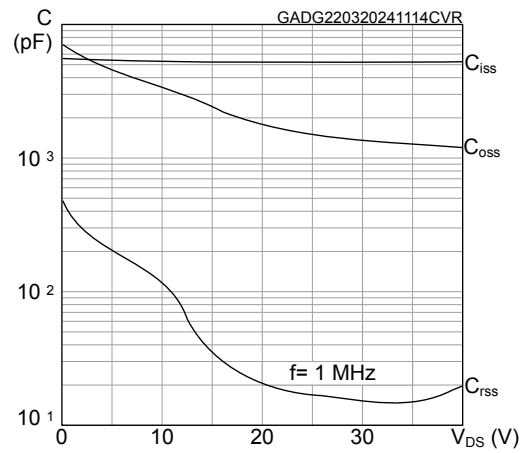

Figure 16. Typical capacitance characteristics



3 Package information

In order to meet environmental requirements, ST offers these devices in different grades of **ECOPACK** packages, depending on their level of environmental compliance. ECOPACK specifications, grade definitions and product status are available at: www.st.com. ECOPACK is an ST trademark.

3.1 PowerFLAT 5x6 type B package information

Figure 17. PowerFLAT 5x6 type B package outline

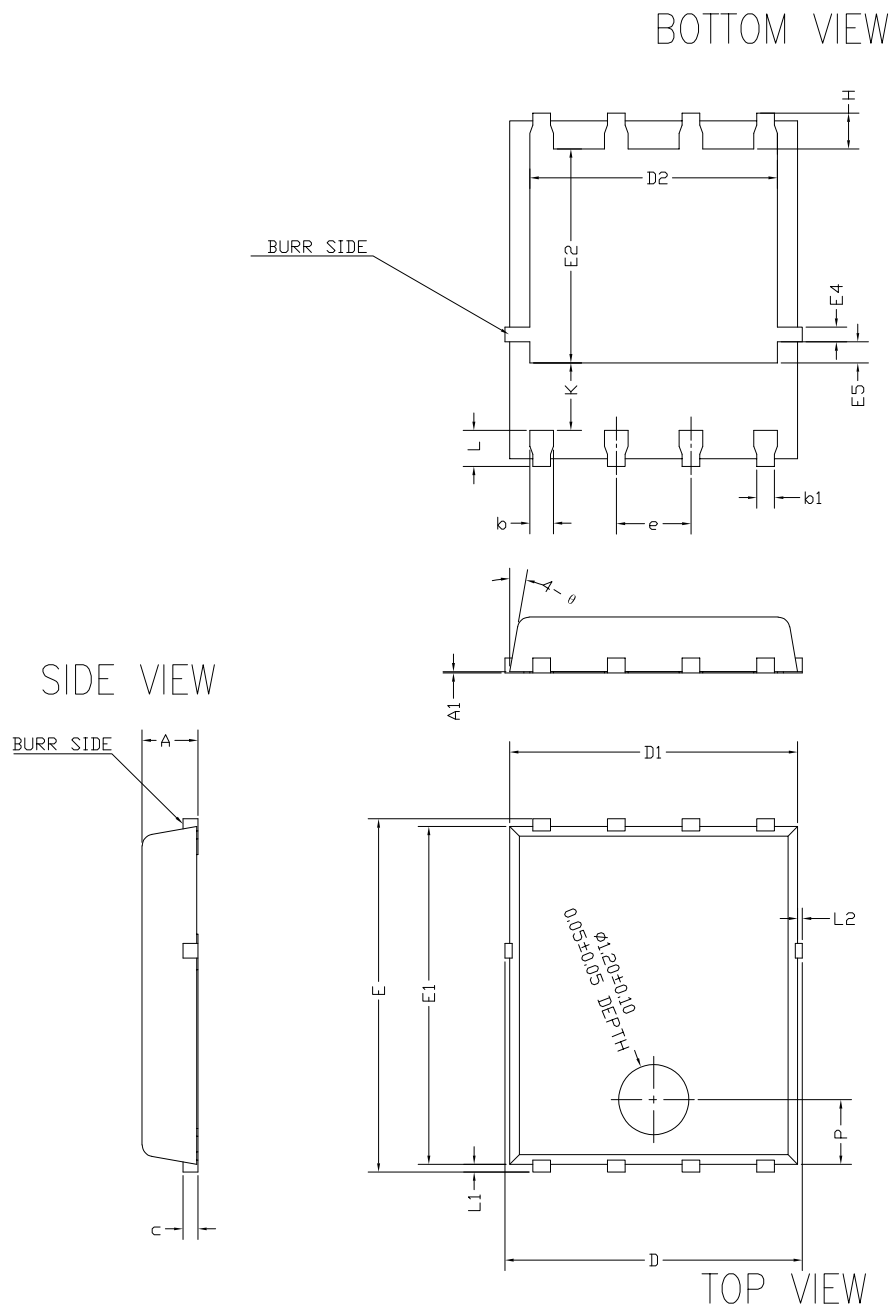

Drawing_8472137_typeB rev5

Table 7. PowerFLAT 5x6 type B mechanical data

Dim.	mm		
	Min.	Typ.	Max.
A	0.90	0.95	1.00
A1		0.02	
b	0.35	0.40	0.45
b1		0.30	
c	0.21	0.25	0.34
D	4.80		5.10
D1	4.80	4.90	5.00
D2	4.01	4.21	4.31
e	1.17	1.27	1.37
E	5.90	6.00	6.10
E1	5.70	5.75	5.80
E2	3.54	3.64	3.74
E4	0.15	0.25	0.35
E5	0.26	0.36	0.46
H	0.51	0.61	0.71
K	0.95		
L	0.51	0.61	0.71
L1	0.06	0.13	0.20
L2			0.10
P	1.00	1.10	1.20
θ	8°	10°	12°

Figure 18. PowerFLAT 5x6 recommended footprint (dimensions are in mm)

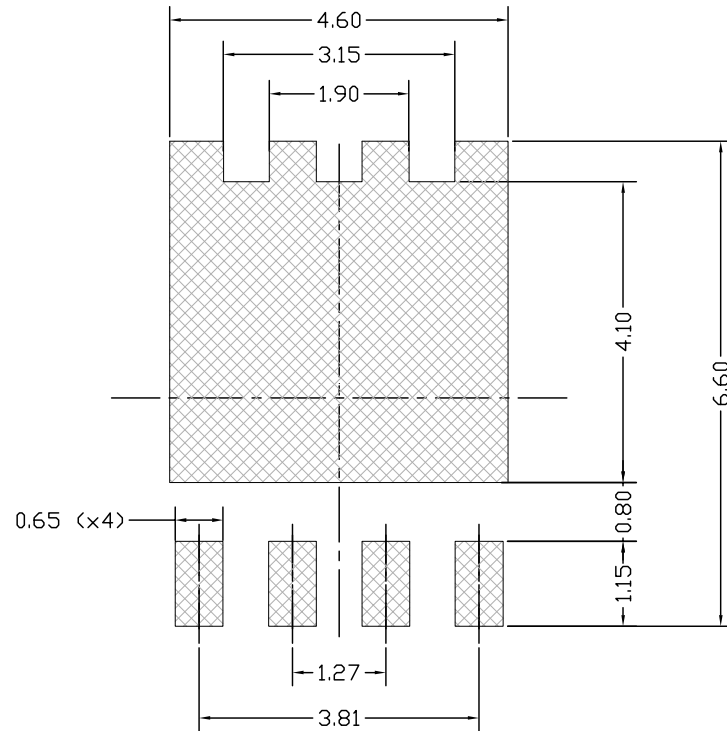

Footprint_8472137_typeB rev5

3.2 PowerFLAT 5x6 packing information

Figure 19. PowerFLAT 5x6 tape (dimensions are in mm)

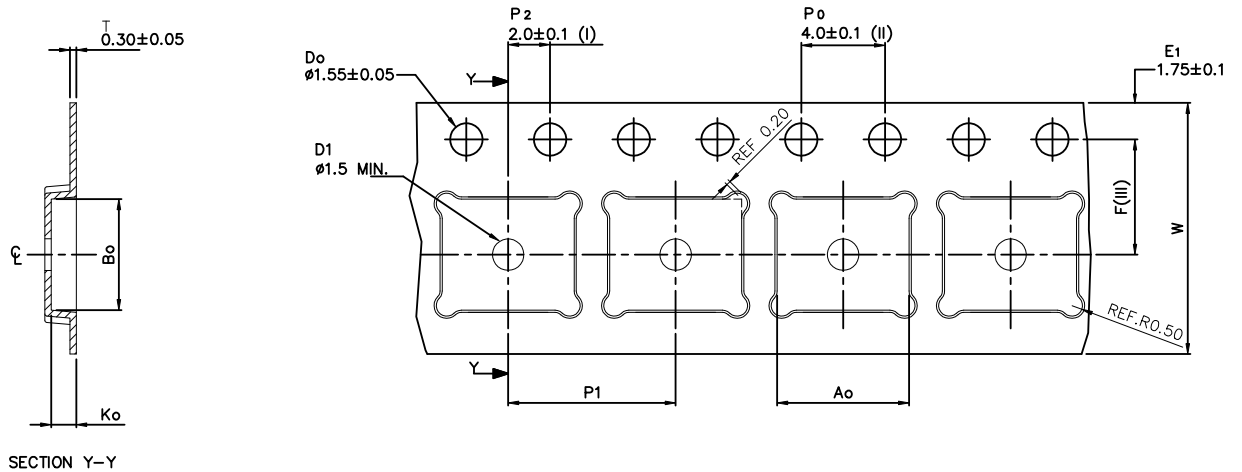

Ao	6.30	+/- 0.1
Bo	5.30	+/- 0.1
Ko	1.20	+/- 0.1
F	5.50	+/- 0.1
P1	8.00	+/- 0.1
W	12.00	+/- 0.3

(I) Measured from centreline of sprocket hole to centreline of pocket.

(II) Cumulative tolerance of 10 sprocket holes is ± 0.20 .

(III) Measured from centreline of sprocket hole to centreline of pocket

Base and bulk quantity 3000 pcs
All dimensions are in millimeters

8234350_Tape_rev_C

Figure 20. PowerFLAT 5x6 package orientation in carrier tape

Pin 1 identification

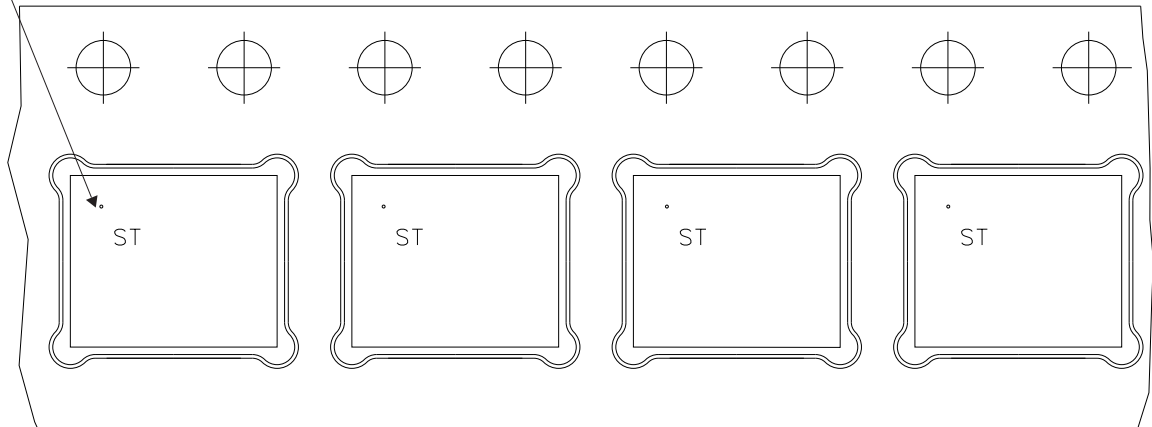
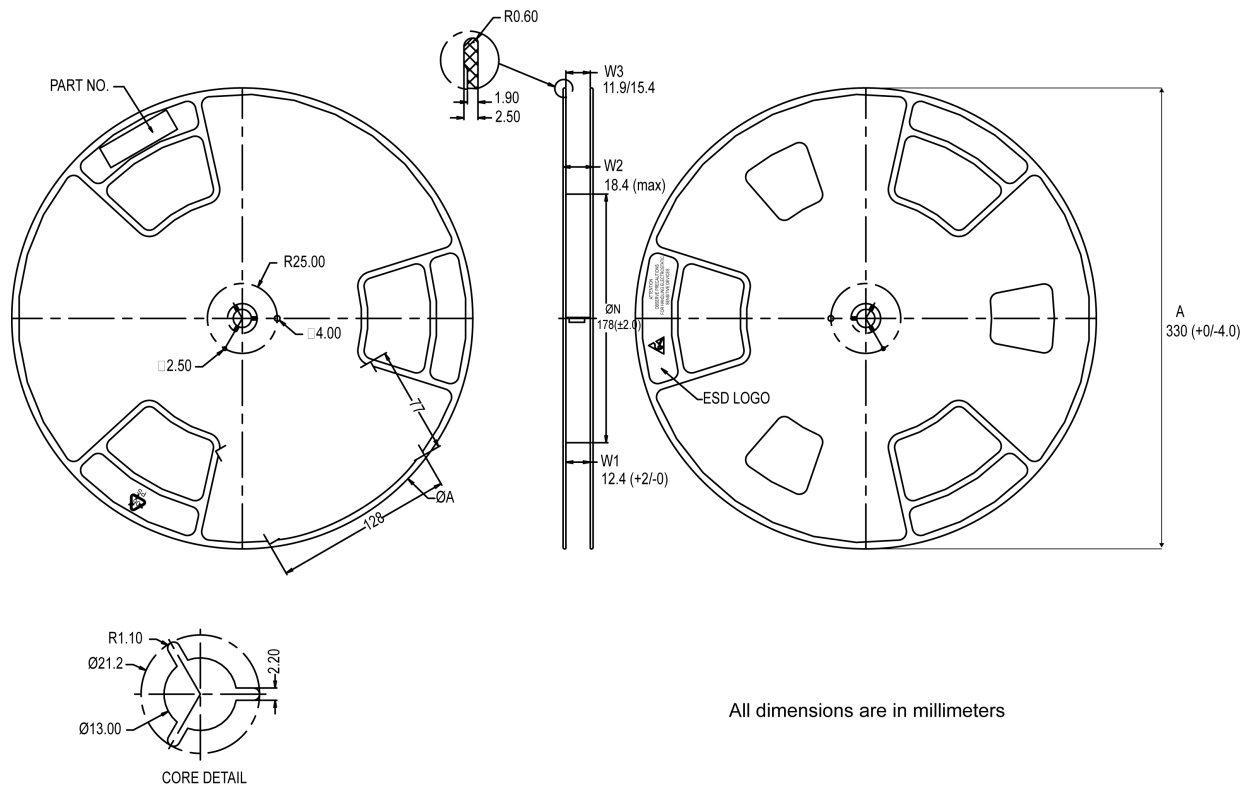

Figure 21. PowerFLAT 5x6 reel



8234350_Reel_rev_C

3.3 PowerFLAT 5x6 marking information

Figure 22. PowerFLAT 5x6 marking information

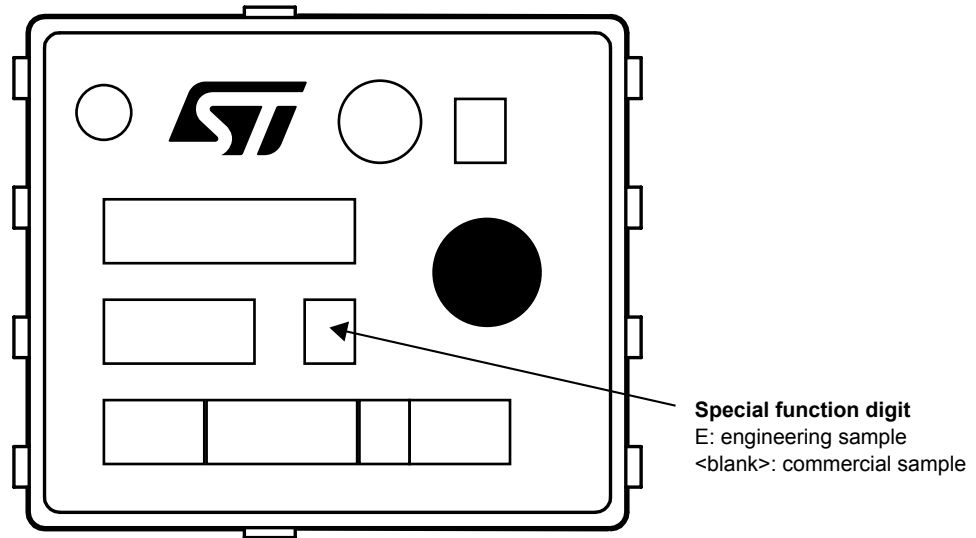

Note: *Engineering Samples: these samples can be clearly identified by a dedicated special symbol in the marking of each unit. These samples are intended to be used for electrical compatibility evaluation only; usage for any other purpose may be agreed only upon written authorization by ST. ST is not liable for any customer usage in production and/or in reliability qualification trials.*

Commercial Samples: fully qualified parts from ST standard production with no usage restrictions.

Revision history

Table 8. Document revision history

Date	Revision	Changes
03-Feb-2023	1	Initial release.
02-Apr-2024	2	<p>Updated Features, Applications and Description.</p> <p>Updated Section 1: Electrical ratings, Section 2: Electrical characteristics and Section 2.1: Electrical characteristics (curves).</p> <p>Added Figure 11. Typical output characteristics, Figure 12. Typical transfer characteristics, Figure 13. Typical drain-source on-resistance , Figure 15. Typical gate charge characteristics and Figure 16. Typical capacitance characteristics .</p>

Contents

1	Electrical ratings	2
2	Electrical characteristics	3
2.1	Electrical characteristics (curves)	5
3	Package information	8
3.1	PowerFLAT 5x6 type B package information	8
3.2	PowerFLAT 5x6 packing information	10
3.3	PowerFLAT 5x6 marking information	12
	Revision history	13

IMPORTANT NOTICE – READ CAREFULLY

STMicroelectronics NV and its subsidiaries (“ST”) reserve the right to make changes, corrections, enhancements, modifications, and improvements to ST products and/or to this document at any time without notice. Purchasers should obtain the latest relevant information on ST products before placing orders. ST products are sold pursuant to ST’s terms and conditions of sale in place at the time of order acknowledgment.

Purchasers are solely responsible for the choice, selection, and use of ST products and ST assumes no liability for application assistance or the design of purchasers’ products.

No license, express or implied, to any intellectual property right is granted by ST herein.

Resale of ST products with provisions different from the information set forth herein shall void any warranty granted by ST for such product.

ST and the ST logo are trademarks of ST. For additional information about ST trademarks, refer to www.st.com/trademarks. All other product or service names are the property of their respective owners.

Information in this document supersedes and replaces information previously supplied in any prior versions of this document.

© 2024 STMicroelectronics – All rights reserved