

## High speed differential line drivers and receivers

### Feature summary

- Meets or exceeds the requirements of ANSI EIA/TIA-644-1995 standard
- Signaling rates up to 400Mbit/s
- Bus terminal ESD exceeds 6kV
- Operates from a single 3.3V supply
- Low-voltage differential signaling with typical output voltage of 350mV and a 100Ω load
- Propagation delay times:  
Driver: 2ns (typ)  
Receiver: 3ns (typ)
- Power dissipation at 200MHz:  
Driver: 25mW (typ)  
Receiver: 60mW (typ)
- LVTTTL input levels are 5V tolerant
- Receiver has open-circuit fail-safe

### Description

The STLVDS051 is differential line drivers and receivers that use low-voltage differential signaling (LVDS) to achieve signaling rates as high as 400Mbps.

The EIA/TIA-644 standard compliant electrical interface provides a minimum differential output voltage magnitude of 247mV into a 100Ω load and receipt of 100mV signals with up to 1V of ground potential difference between a transmitter and receiver.

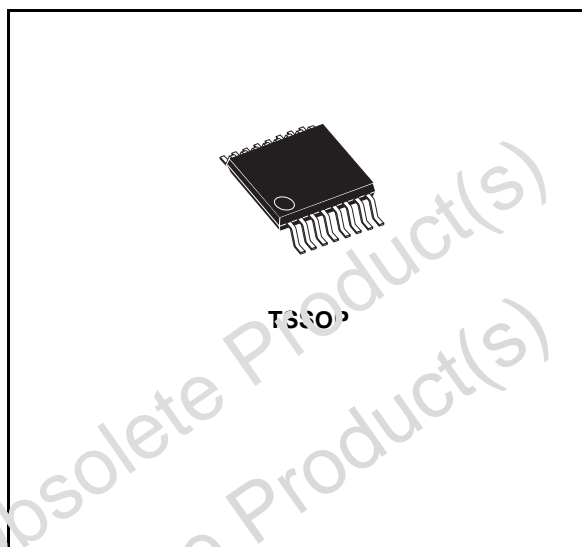

The intended application of this device and signaling technique is for point-to-point baseband data transmission over controlled impedance media of approximately 100Ω characteristic impedance.

The transmission media may be printed-circuit board traces, backplanes, or cables. (Note: The ultimate rate and distance of data transfer is dependent upon the attenuation characteristics of the media, the noise coupling to the environment, and other application specific characteristics).

### Order codes

Part number	Temperature Range	Package	Comments
STLVDS051BTR	-40 to 85 °C	TSSOP16 (Tape & Reel)	2500 parts per reel

---

## Contents

1	Pin configuration .....	3
2	Maximum ratings .....	5
3	Electrical characteristics .....	6
4	Typical performance characteristics .....	9
5	Package mechanical data .....	11
6	Revision history .....	14

Obsolete Product(s) - Obsolete Product(s)  
Obsolete Product(s) - Obsolete Product(s)

# 1 Pin configuration

Figure 1. Pin connections and functional diagram

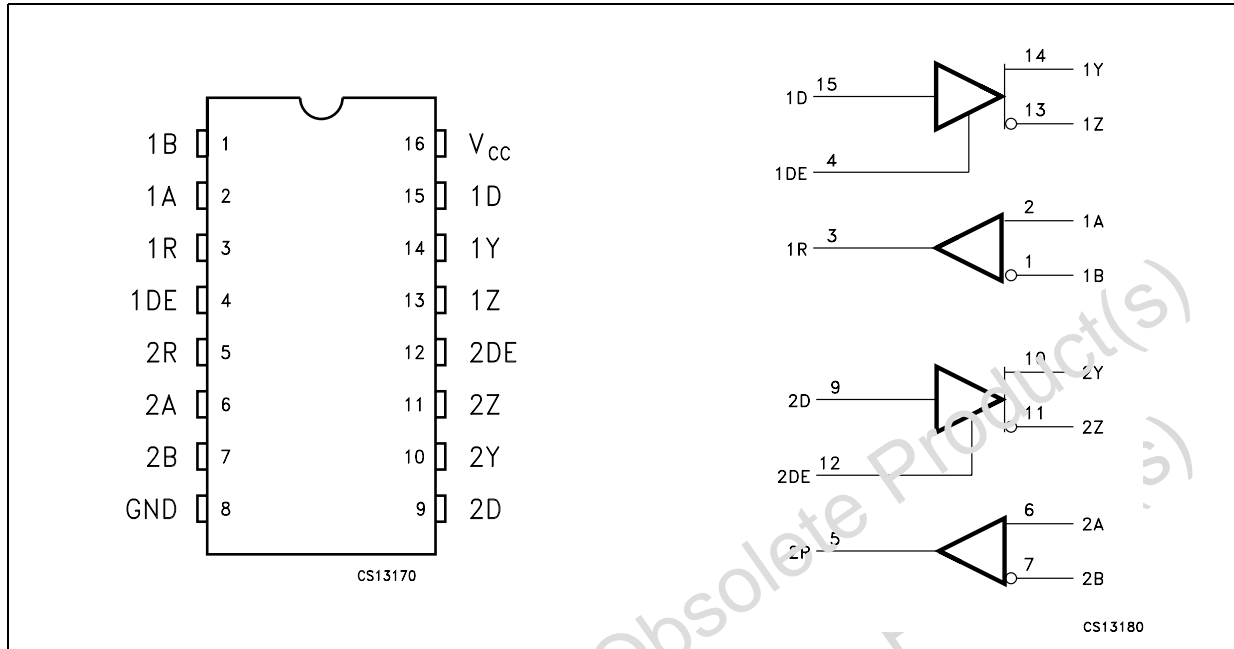

Table 1. Pin description

Pin n°	Symbol	Name and function
1, 2, 6, 7	1A, 1B, 2A, 2B	Receiver inputs
3, 5	1R, 2R	Receiver outputs
4, 12	1DE, 2DE	Driver enable
9, 15	2D, 1D	Driver inputs
10, 11, 13, 14	2Y, 2Z, 1Y, 1Z	Driver outputs
8	GND	Ground
16	V <sub>CC</sub>	Supply voltage

Table 2. Truth table for receiver

$V_{ID} = V_A - V_B$	R
$V_{ID} \geq 100\text{mV}$	H
$-100\text{mV} < V_{ID} < 100\text{mV}$	?
$V_{ID} \leq -100\text{mV}$	L
OPEN	H

**Table 3. Truth table for driver**

D	DE	Y	Z
L	H	L	H
H	H	H	L
OPEN	H	L	H
X	L	Z	Z

L=Low level, H=High Level, X=Don't care, Z= High Impedance

Obsolete Product(s) - Obsolete Product(s)  
Obsolete Product(s) - Obsolete Product(s)

## 2 Maximum ratings

**Table 4. Absolute maximum ratings**

Symbol	Parameter		Value	Unit
$V_{CC}$	Supply voltage		-0.5 to 4	V
$V_I$	Voltage range	D, R, DE	-0.5 to 6	V
ESD	ESD Protection voltage (HBM)	Y, Z, A, B, and GND	$\pm 6$	kV
		All Pins	$\pm 3$	
$T_{STG}$	Storage temperature range		-65 to 150	$^{\circ}\text{C}$

*Note:* Absolute Maximum Ratings are those values beyond which damage to the device may occur. Functional operation under these condition is not implied.

**Table 5. Recommended operating conditions**

Symbol	Parameter	Min.	Typ.	Max.	Unit
$V_{CC}$	Supply voltage	3.0	3.3	3.6	V
$V_{IH}$	HIGH level input voltage	2.0			V
$V_{IL}$	LOW level input voltage			0.8	V
$ V_{ID} $	Magnitude of differential input voltage	0.1		0.6	V
$V_{IC}$	Common mode input voltage	$ V_{ID} /2$		$24- V_{ID} /2$	V
				$V_{CC}-0.8$	
$T_A$	Operating temperature range	-40		85	$^{\circ}\text{C}$

### 3 Electrical characteristics

**Table 6. Electrical characteristics**

(Typical values are at  $T_A = 25^\circ\text{C}$ ,  $V_{CC} = 3.3\text{V} \pm 10\%$ ,  $T_A = -40$  to  $85^\circ\text{C}$  unless otherwise specified).

Symbol	Parameter	Test	Min.	Typ.	Max.	Unit
$I_{CC}$	Supply Current	Drivers enabled, no receiver loads, driver $R_L=100\Omega$		12	20	mA
		Drivers disabled, no load		4	6	

**Table 7. Driver electrical characteristics**

(Typical values are at  $T_A = 25^\circ\text{C}$ ,  $V_{CC} = 3.3\text{V} \pm 10\%$ ,  $T_A = -40$  to  $85^\circ\text{C}$  unless otherwise specified).

Symbol	Parameter	Test	Min.	Typ.	Max.	Unit
$ V_{OD} $	Differential output voltage magnitude	$R_L = 100\Omega$	247	340	454	mV
$\Delta V_{OD} $	Change in differential output voltage magnitude between logic states	$R_L = 100\Omega$	-50		50	mV
$\Delta V_{OC(SS)}$	Change in steady-state common mode output voltage between logic states		-50		50	mV
$V_{OC(SS)}$	Steady-state common mode output voltage		1.125	1.2	1.375	V
$V_{OC(PP)}$	Peak to peak common mode output voltage			50	150	mV
$I_{IH}$	High level input current	$V_{IH} = 5\text{V}$	DE	-0.5	-20	$\mu\text{A}$
			D		2	20
$I_{IL}$	Low level input current	$V_{IL} = 0.8\text{V}$	DE	-0.5	-10	$\mu\text{A}$
			D		1	10
$I_{OS}$	Short circuit output current	$V_{O(Y)}$ or $V_{O(Z)} = 0\text{V}$		6	10	mA
		$V_{OD} = 0$		4	10	mA
$I_{OZ}$	High impedance output current	$V_O = 600\text{mV}$			$\pm 1$	$\mu\text{A}$
		$V_O = 0\text{V}$ or $V_{CC}$			$\pm 1$	$\mu\text{A}$
$I_{O(OFF)}$	Power OFF output current	$V_{CC} = 0\text{V}$ , $V_O = 3.6\text{V}$			$\pm 1$	$\mu\text{A}$
$C_{IN}$	Input capacitance			3		pF

**Table 8. Receiver electrical characteristics**

(Typical values are at  $T_A = 25^\circ\text{C}$ ,  $V_{CC} = 3.3\text{V} \pm 10\%$ ,  $T_A = -40$  to  $85^\circ\text{C}$  unless otherwise specified).

Symbol	Parameter	Test	Min.	Typ.	Max.	Unit
$V_{ITH+}$	Positive-going differential input voltage threshold				100	mV
$V_{ITH-}$	Negative-going differential input voltage threshold		-100			mV
$V_{OH}$	High level output voltage	$I_{OH} = -8\text{mA}$	2.4			V
$V_{OL}$	Low level output voltage	$I_{OL} = 2\text{mA}$			0.4	V
$I_I$	Input current (A or B Inputs)	$V_I = 0\text{V}$	-2	-11	-20	$\mu\text{A}$
		$V_I = 2.4\text{V}$	-1	-3		$\mu\text{A}$
$I_{I(OFF)}$	Power OFF input current (A or B Inputs)	$V_{CC} = 0\text{V}$			$\pm 20$	$\mu\text{A}$
$I_{IH}$	High level input current (Enable)	$V_{IH} = 5\text{V}$			$\pm 10$	$\mu\text{A}$
$I_{IL}$	Low level input current (Enable)	$V_{IL} = 0.8\text{V}$			$\pm 10$	$\mu\text{A}$
$I_{OZ}$	High impedance output current	$V_O = 0$ or $5\text{V}$			$\pm 10$	$\mu\text{A}$
$C_{IN}$	Input capacitance			3		pF

**Table 9. Driver switching characteristics**

(Typical values are at  $T_A = 25^\circ\text{C}$ ,  $V_{CC} = 3.3\text{V} \pm 10\%$ ,  $T_A = -40$  to  $85^\circ\text{C}$  unless otherwise specified).

Symbol	Parameter	Test	Min.	Typ.	Max.	Unit	
$t_{PLH}$	Propagation delay time, low to high output	$R_L = 100\Omega$ $C_L = 10\text{pF}$		2	2.7	ns	
$t_{PHL}$	Propagation delay time, high to low output			2	2.7	ns	
$t_r$	Differential output signal rise time				0.4	1	ns
$t_f$	Differential output signal fall time				0.4	1	ns
$t_{sk(P)}$	Pulse skew ( $ t_{THL} - t_{TLH} $ ) <sup>(1)</sup>				50		ps
$t_{sk(O)}$	Channel-to-channel output skew <sup>(2)</sup>				40		ps
$t_{PZH}$	Propagation delay time, high impedance to high level output				6	10	ns
$t_{PZL}$	Propagation delay time, high impedance to low level output				6	10	ns
$t_{PHZ}$	Propagation delay time, high level to high impedance output			3	10	ns	
$t_{PLZ}$	Propagation delay time, low level to high impedance output			3	10	ns	

1.  $t_{sk(P)}$  is the magnitude of the time difference between the high to low and low to high propagation delay times at an output

2.  $t_{sk(O)}$  is the magnitude of the time difference between the output of a single device with all their inputs connected together

**Table 10. Receiver switching characteristics**

(Typical values are at  $T_A = 25^\circ\text{C}$ ,  $V_{CC} = 3.3\text{V} \pm 10\%$ ,  $T_A = -40$  to  $85^\circ\text{C}$  unless otherwise specified).

Symbol	Parameter	Test	Min.	Typ.	Max.	Unit	
$t_{PLH}$	Propagation delay time, low to high output	$C_L = 10\text{pF}$		3.0	4.0	ns	
$t_{PHL}$	Propagation delay time, high to low output			3.0	4.0	ns	
$t_r$	Differential output signal rise time			0.6	1	ns	
$t_f$	Differential output signal fall time			0.6	1	ns	
$t_{sk(P)}$	Pulse skew ( $ t_{THL} - t_{TLH} $ ) (Note 1)				0.25	1	ns
$t_{PZH}$	Propagation delay time, high impedance to high level output			2.5		ns	
$t_{PZL}$	Propagation delay time, high impedance to low level output			2.5		ns	
$t_{PHZ}$	Propagation delay time, high level to high impedance output				7		ns
$t_{PLZ}$	Propagation delay time, low level to high impedance output				4		ns

Note 1:  $t_{sk(P)}$  is the magnitude of the time difference between the high to low and low to high propagation delay times at an output

Note 2:  $t_{sk(O)}$  is the magnitude of the time difference between the output of a single device with all their inputs connected together.

Note 3:  $t_{sk(PP)}$  is the magnitude of the difference between any specified terminals of two devices when both devices operate with the same supply voltages, same temperature, and have identical packages and test circuit



## 4 Typical performance characteristics

(Unless otherwise specified  $T_J = 25^\circ\text{C}$ )

**Figure 2. Output current vs output high voltage for receiver**

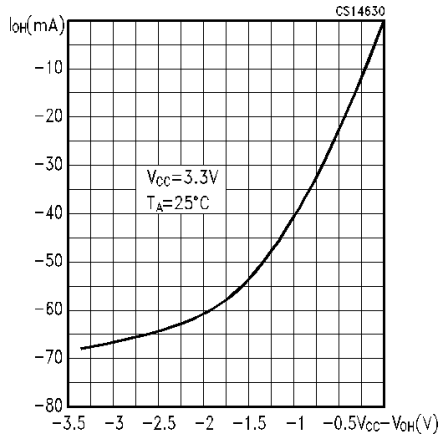

**Figure 3. Output current vs output low voltage for receiver**

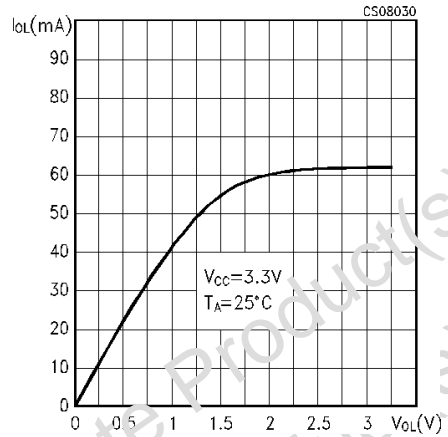

**Figure 4. Output current vs output high voltage for driver**

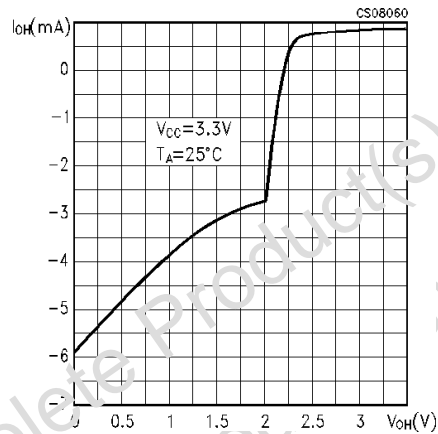

**Figure 5. Output current vs output low voltage for driver**

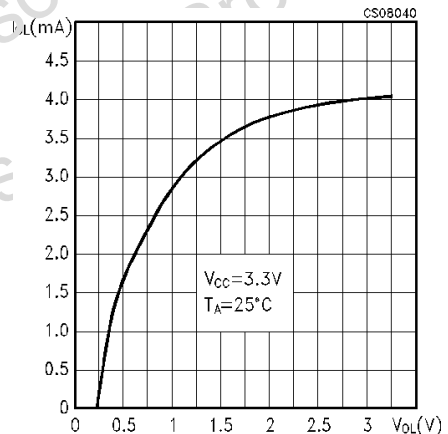

**Figure 6. High to low propagation delay time for receiver**

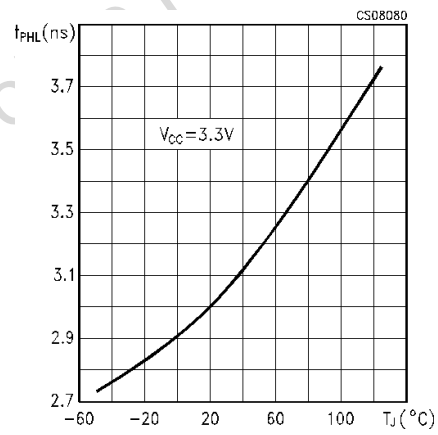

**Figure 7. Low to high propagation delay time for receiver**

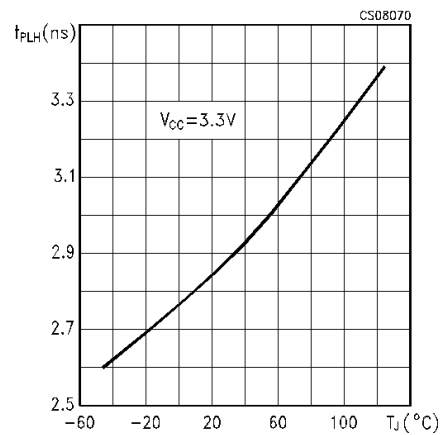

**Figure 8. High to low propagation delay time for driver**

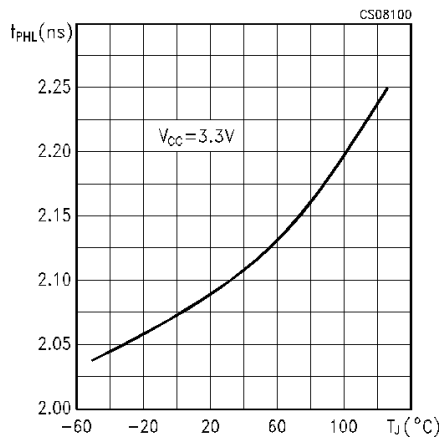

**Figure 9. Low to high propagation delay time for driver**

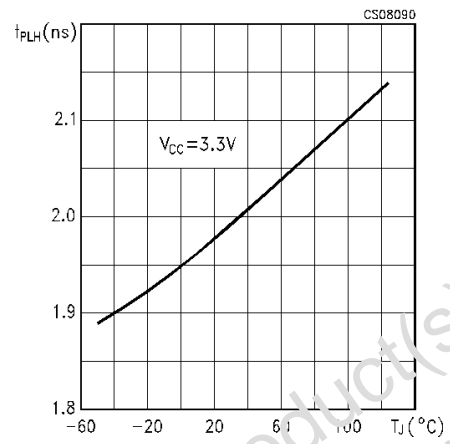

Obsolete Product(s) - Obsolete Product(s)  
 Obsolete Product(s) - Obsolete Product(s)

## 5 Package mechanical data

In order to meet environmental requirements, ST offers these devices in ECOPACK® packages. These packages have a Lead-free second level interconnect. The category of second Level Interconnect is marked on the package and on the inner box label, in compliance with JEDEC Standard JESD97. The maximum ratings related to soldering conditions are also marked on the inner box label. ECOPACK is an ST trademark. ECOPACK specifications are available at: [www.st.com](http://www.st.com).

Obsolete Product(s) - Obsolete Product(s)  
Obsolete Product(s) - Obsolete Product(s)

**TSSOP16 MECHANICAL DATA**

DIM.	mm.			inch		
	MIN.	TYP	MAX.	MIN.	TYP.	MAX.
A			1.2			0.047
A1	0.05		0.15	0.002	0.004	0.006
A2	0.8	1	1.05	0.031	0.039	0.041
b	0.19		0.30	0.007		0.012
c	0.09		0.20	0.004		0.0079
D	4.9	5	5.1	0.193	0.197	0.201
E	6.2	6.4	6.6	0.244	0.252	0.260
E1	4.3	4.4	4.48	0.169	0.173	0.176
e		0.65 BSC			0.0256 BSC	
K	0°		3°	0°		8°
L	0.45	0.60	0.75	0.018	0.024	0.030

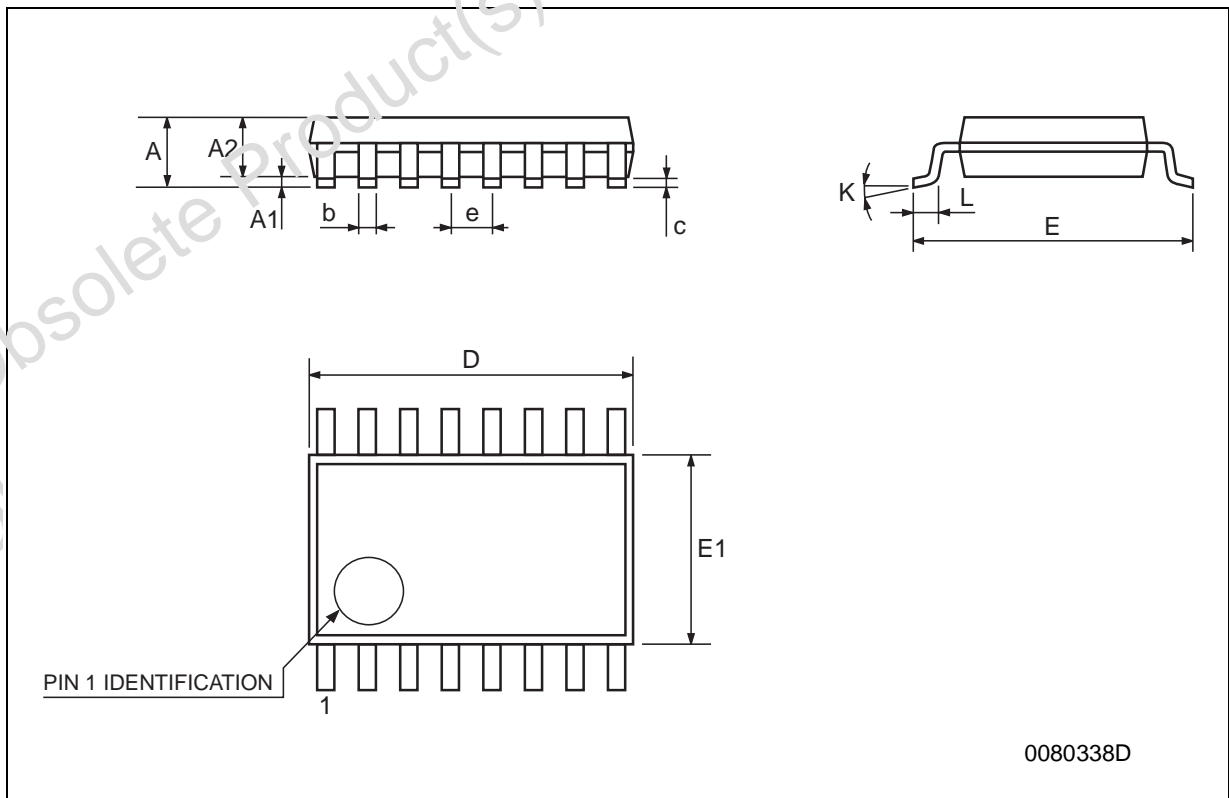

**Tape & Reel TSSOP16 MECHANICAL DATA**

DIM.	mm.			inch		
	MIN.	TYP	MAX.	MIN.	TYP.	MAX.
A			330			12.992
C	12.8		13.2	0.504		0.519
D	20.2			0.795		
N	60			2.362		
T			22.4			0.882
Ao	6.7		6.9	0.264		0.272
Bo	5.3		5.5	0.209		0.217
Ko	1.6		1.8	0.063		0.071
Po	3.9		4.1	0.153		0.161
P	7.9		8.1	0.311		0.319

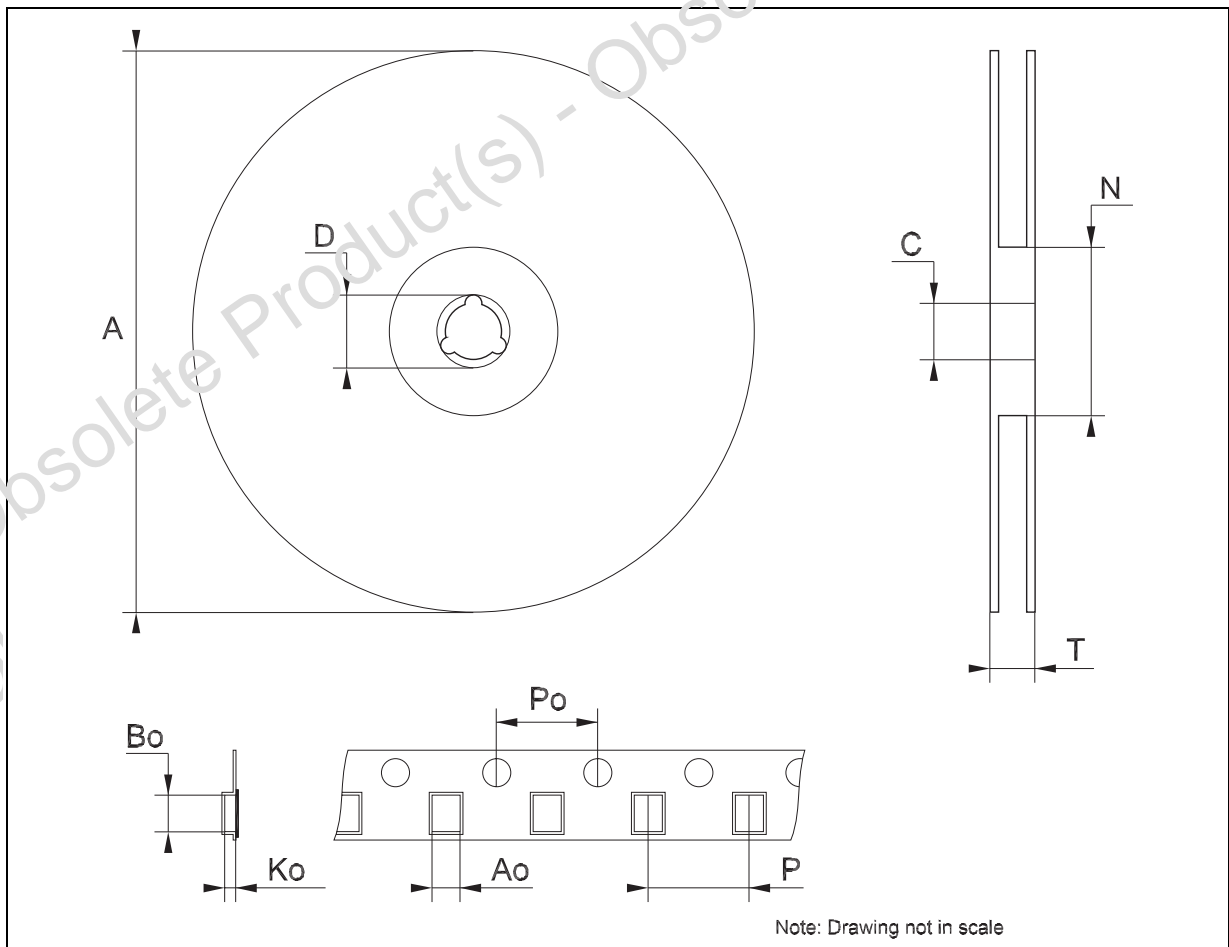

## 6 Revision history

Table 11. Revision history

Date	Revision	Changes
22-Mar-2006	4	Order codes has been updated and new template.

Obsolete Product(s) - Obsolete Product(s)  
Obsolete Product(s) - Obsolete Product(s)

**Please Read Carefully:**

Information in this document is provided solely in connection with ST products. STMicroelectronics NV and its subsidiaries ("ST") reserve the right to make changes, corrections, modifications or improvements, to this document, and the products and services described herein at any time, without notice.

All ST products are sold pursuant to ST's terms and conditions of sale.

Purchasers are solely responsible for the choice, selection and use of the ST products and services described herein, and ST assumes no liability whatsoever relating to the choice, selection or use of the ST products and services described herein.

No license, express or implied, by estoppel or otherwise, to any intellectual property rights is granted under this document. If any part of this document refers to any third party products or services it shall not be deemed a license grant by ST for the use of such third party products or services, or any intellectual property contained therein or considered as a warranty covering the use in any manner whatsoever of such third party products or services or any intellectual property contained therein.

**UNLESS OTHERWISE SET FORTH IN ST'S TERMS AND CONDITIONS OF SALE ST DISCLAIMS ANY EXPRESS OR IMPLIED WARRANTY WITH RESPECT TO THE USE AND/OR SALE OF ST PRODUCTS INCLUDING WITHOUT LIMITATION IMPLIED WARRANTIES OF MERCHANTABILITY, FITNESS FOR A PARTICULAR PURPOSE (AND THEIR EQUIVALENTS UNDER THE LAWS OF ANY JURISDICTION), OR INFRINGEMENT OF ANY PATENT, COPYRIGHT OR OTHER INTELLECTUAL PROPERTY RIGHT.**

**UNLESS EXPRESSLY APPROVED IN WRITING BY AN AUTHORIZED REPRESENTATIVE OF ST, ST PRODUCTS ARE NOT DESIGNED, AUTHORIZED OR WARRANTED FOR USE IN MILITARY, AIR CRAFT, SPACE, LIFE SAVING, OR LIFE SUSTAINING APPLICATIONS, NOR IN PRODUCTS OR SYSTEMS, WHERE FAILURE OR MALFUNCTION MAY RESULT IN PERSONAL INJURY, DEATH, OR SEVERE PROPERTY OR ENVIRONMENTAL DAMAGE.**

Resale of ST products with provisions different from the statements and/or technical features set forth in this document shall immediately void any warranty granted by ST for the ST product or service described herein and shall not create or extend in any manner whatsoever, any liability of ST.

ST and the ST logo are trademarks or registered trademarks of ST in various countries.

Information in this document supersedes and replaces all information previously supplied.

The ST logo is a registered trademark of STMicroelectronics. All other names are the property of their respective owners.

© 2006 STMicroelectronics - All rights reserved

STMicroelectronics group of companies

Australia - Belgium - Brazil - Canada - China - Czech Republic - Finland - France - Germany - Hong Kong - India - Israel - Italy - Japan - Malaysia - Malta - Morocco - Singapore - Spain - Sweden - Switzerland - United Kingdom - United States of America

[www.st.com](http://www.st.com)